



# GEFORCE® RTX

## Installation Guide

### Hardware Installation

1. Turn off your computer, disconnect the power cord and remove any existing graphics card(s).

**Attention:** It is very important that you wait until the graphics card has cooled down before taking the card out of the system.

2. Remove the slot covers that correspond to the PCIe slots you are installing the GeForce® graphics card in (if there was no existing graphics card).
3. Install the GeForce® graphics card, as shown below. If this card is going into an SLI® configuration, follow the directions for the number of cards you will be installing.

**Note :** All of the graphics cards in an SLI® configuration must be identical.

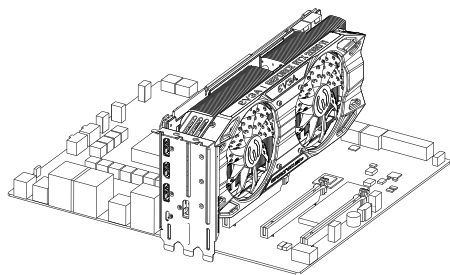
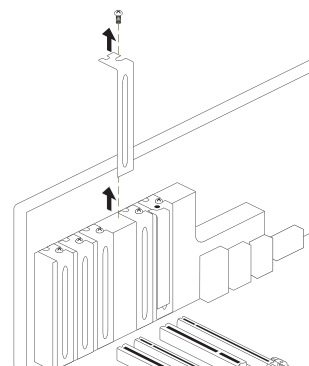

Install your first GeForce® graphics card into the Primary PCIe x16 slot (the Primary slot is the one closest to the CPU).

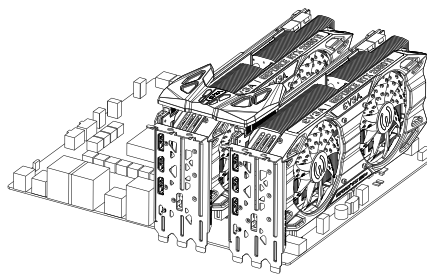

**2-way SLI:** Install your second GeForce® graphics card in the secondary PCIe x16 slot. Connect the two cards together using a 2-way SLI bridge.

\*NVLink™ technology is only supported by each GPU Specification.

E099-00-000253

Installation Guide



4. Connect system power to the GeForce® graphics card.

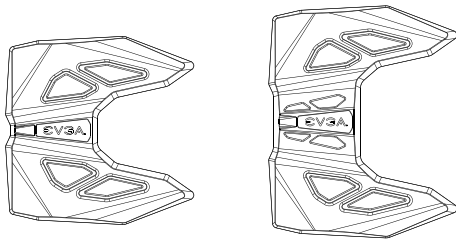

2-Way 3 Slot SLI

2-Way 4 Slot SLI

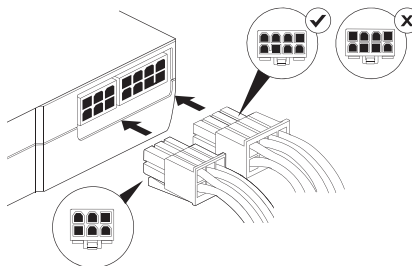

GeForce® graphics cards require PCIe power plugs from the system power supply. Ensure that all pins are populated by using the proper 6 or 8 pin PCIe connector.

5. Reinstall the covers on your computer and reconnect any previously removed display cables.

Option 1

Option 2

Option 3

Option 4

Option 5

Option 6

Option 7

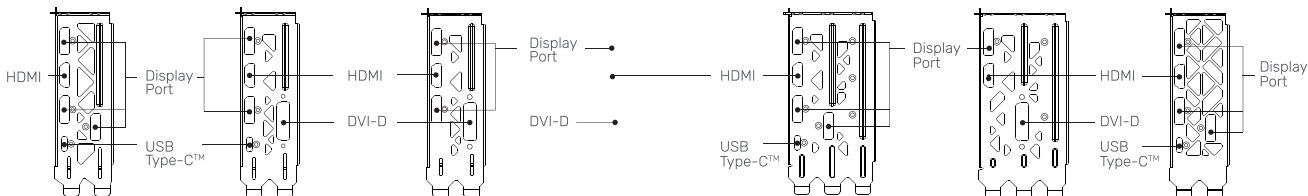

## Connecting to the Display

1. Connect the display(s) to the graphics card.
2. Reconnect your power cord to the PC.

## Driver Installation

With the hardware installed, it is now time to install the graphics driver.

1. Power up your computer.
2. Download the driver file from [www.evga.com/drivers](http://www.evga.com/drivers). The setup program will take over and walk you through the driver installation process.
3. You may need to reboot your PC once the driver installation is complete.

## Minimum System Requirements

### Motherboard:

- PCIe, PCIe 2.0 or PCIe 3.0-compliant motherboard with one dual-width graphics slot. For an SLI® configuration, you need an NVIDIA NVLink™ (NVIDIA SLI®) motherboard.

### System Power Supply:

- GeForce® RTX 2080Ti / 2080 / 2070 : 650W power supply with one of the following PCIe power connectors.
- GeForce® RTX 2060 : 500W power supply with one of the following PCIe power connectors.

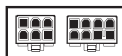

Option 1

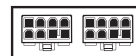

Option 2



Option 3

For power supply recommendations for SLI® configurations, visit [www.geforce.com/sli](http://www.geforce.com/sli) and check the Certified Products section.

### Operating System:

- Microsoft Windows®10 64-bit(April 2018 Update or later) ▪ Windows® 7 64-bit, Linux64-bit

## Included Equipment

The following equipment is included in the EVGA GeForce® graphics card box.

- Installation Guide ▪ EVGA Accessory Pack

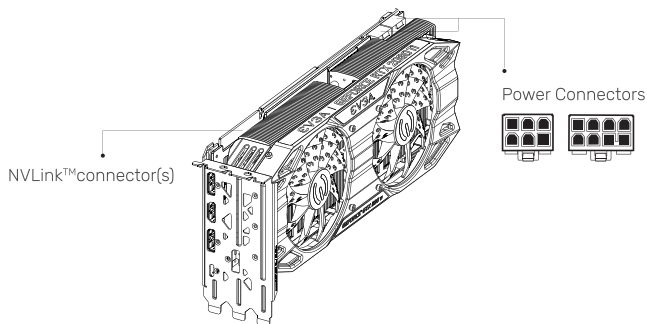

The terms HDMI and HDMI High-Definition Multimedia Interface, and the HDMI logo are trademarks or registered trademarks of HDMI Licensing LLC in the United States and other countries.