



# HP Rack & Power Solutions/ Reference guide



Businesses across the world rely on HP Qualified Options to complete their data centres. Boost the power, performance and reliability of your data centre with Rack & Power solutions.

*hp*  
**QUALIFIED  
OPTIONS**



# HP Rack & Power Solutions/ Reference guide

Edition 5

## Table of contents:

HP Qualified Options . . . . .	4
HP Rack & Power Solutions . . . . .	5
Racks . . . . .	6
Rack options . . . . .	7
Cooling . . . . .	8
Management – KVM solutions . . . . .	9
Management – Consoles . . . . .	11
UPS solutions – 1Phase – Tower . . . . .	12
UPS solutions – 1Phase – Rack . . . . .	13
3Phase power solutions (UPS, PDR) . . . . .	14
PDU solutions . . . . .	16
HP Factory Express Services . . . . .	18

Name:

---

Company:

---

Address 1:

---

Address 2:

---

Phone/Fax:

---

E-mail:

---

# HP Qualified Options

Completing your data centre and removing data centre boundaries

HP Qualified Options strengthen the foundation of your data centre with high-calibre products that are easy to maintain and tailored for ProLiant, Integrity and StorageWorks, giving you confidence in your whole infrastructure.

HP Qualified Options has passed our rigorous qualification processes. Experience dependable quality you can count on, and when you need it, use outstanding HP support services for your whole environment. When you purchase HP hardware, don't compromise on the quality of your options. With HP Qualified Options, you can be confident of your whole infrastructure.

#### **Dependable quality**

Deliver greater business performance with fewer interruptions when you complete your infrastructure with HP options.

#### **Simplified support**

Free up your valuable time when you have HP's high-calibre technical expertise, keeping your whole business in business.

#### **Tailored for ProLiant/Integrity/StorageWorks**

Focus on growing your business and not maintaining IT when you optimise your infrastructure with HP options designed for servers and storage.

#### **Energy maximisation**

Get more out of IT as you stretch the limits of your data centre's power and cooling capabilities.

#### **Data centre adaptability**

Effortlessly manage changing energy demands as you grow IT to accelerate business performance.

#### **Environmental transformation**

Gain IT flexibility and overcome tomorrow's data centre limitations today with innovative solutions built for your business's success.

[www.hp.com/go/qualifiedoptions](http://www.hp.com/go/qualifiedoptions)

HP Rack & Power Solutions are part of the HP Qualified Options portfolio – read more on the next page.



# HP Rack & Power Solutions

Completing your data centre and removing data centre boundaries



## HP Rack & Power Solutions are the foundation for your IT.

HP takes a holistic approach to power and cooling issues, from end to end (from chip to chiller). HP Rack & Power Solutions are part of HP's end-to-end solution, and are important if you want to increase energy-efficiency of your IT infrastructure.

HP has designed these solutions to ensure current and future integration with HP ProLiant, BladeSystem and Integrity servers, HP StorageWorks and HP Systems Insight Manager.

HP offers a one-stop shop for your ongoing physical infrastructure needs – from solutions to services.

**HP Qualified Options and HP Rack & Power Solutions** simplify product and vendor qualifications, procurement and customer support, and guarantee product compatibility as well. This all secures long-term scalability, energy efficiency and investment protection.

**Over 17 million servers sold worldwide – so turn to the one stop you've trusted so far.**

## HP Rack & Power Solutions are built on:

- **Rack and rack options** – to provide the base for a flexible, adaptive IT infrastructure
- **Power solutions** – to protect, distribute and monitor power
- **Access and monitoring solutions** – to harmonise the management of heterogeneous servers, storage and IT infrastructure
- **Cooling solutions** – to handle increased heat and increase cooling efficiency at rack and data centre level

## Synergy and integration is the difference

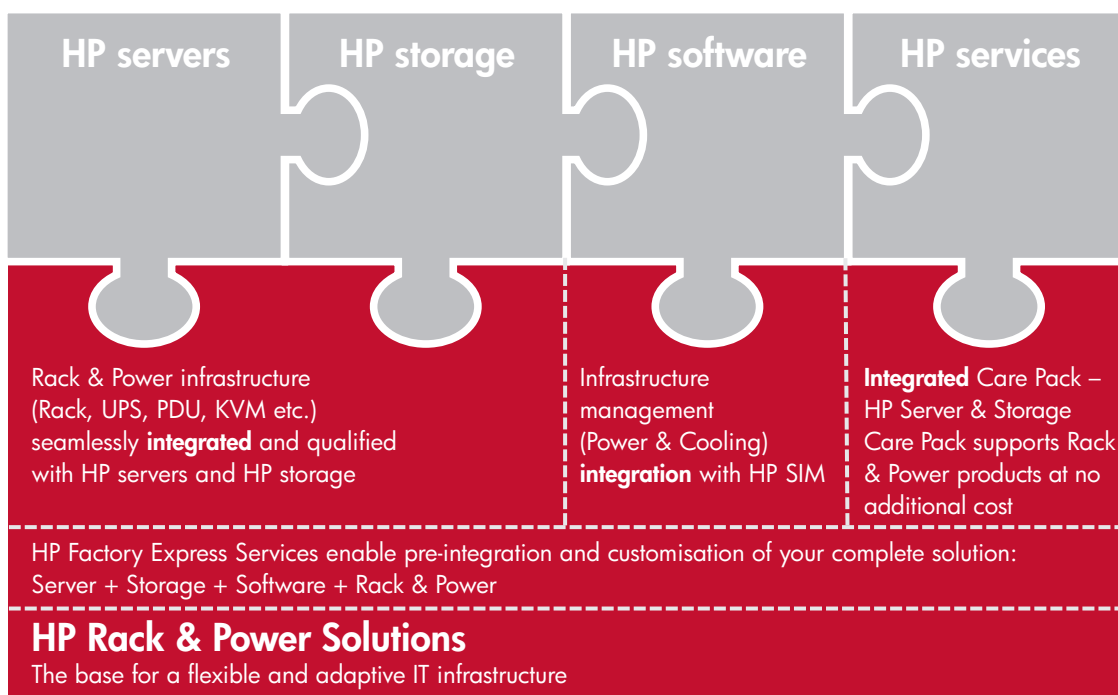

If you need help sizing your HP Rack and Power infrastructure solution (Rack, Rack options, UPS, PDU, KVM), please go to [www.hprackandpowersizer.com](http://www.hprackandpowersizer.com)

## HP racks

- **Industry standard** – to secure compatibility and your investment protection
- **Universal** – qualified with HP server and storage, to secure compatibility and your investment protection
- **Cool** – fully perforated doors and excellent cable management to maximise airflow
- **Flexible, with wide range of racks and rack options** – to meet your individual needs
- **Easy installation** – to deploy your IT easier and faster, and reduce costs
- **Fast IT deployment** – possible to ship racks preconfigured (ready to deploy) with shipping option “shock pallet” and HP Factory Express Rack Integration Service



10636 G2 10642 G2



10842 G2 10647 G2

### HP Universal Rack – HP Rack 10000 G2 Series

Model	U Height	Dimensions (H x W x D)	Dynamic load	Static load	Part number	Shipped with	Shipping option
10622 G2	22U	1092 x 609.6 x 1008 mm (43 x 24 x 39.691 in)	474 kg (1045 lbs)	908 kg (2000 lbs)	AF021A	front door, rear door, side panel, stabiliser kit	Standard pallet
					AF022A	front door, rear door, side panel, stabiliser kit	Shock pallet <sup>1</sup>
10636 G2	36U	1742.4 x 609.6 x 1008 mm (68.6 x 24 x 39.691 in)	690 kg (1520 lbs)	908 kg (2000 lbs)	AF011A	front door, rear door	Standard pallet
					AF012A	front door, rear door	Shock pallet <sup>1</sup>
10642 G2	42U	1999.8 x 609.6 x 1008 mm (78.7 x 24 x 39.691 in)	908 kg (2000 lbs)	1360 kg (3000 lbs)	AF001A	front door, rear door	Standard pallet
					AF002A	front door, rear door	Shock pallet <sup>1</sup>
					AF038A	front door, rear door, rear extension (200 mm)	Standard pallet
10842 G2	42U Wide	1999.8 x 800.1 x 1008 mm (78.7 x 31.5 x 39.691 in)	453 kg (1000 lbs)	908 kg (2000 lbs)	AF041A	front door, rear door	Standard pallet
					AF042A	front door, rear door	Shock pallet <sup>1</sup>
10647 G2	47U	2285 x 609.6 x 1008 mm (89.96 x 24 x 39.69 in)	See note 2	908 kg (2000 lbs)	AF031A	front door, rear door	Standard pallet
					AF045A	front door, rear door, rear extension (200 mm)	Standard pallet
							AF044A

### HP Rack 10000 G1 Series

Model	U Height	Dimensions (H x W x D)	Dynamic load	Static load	Part number	Shipped with	Shipping option
S10614	14U	724 x 600 x 1000 mm (28.5 x 23.62 x 39.37 in)	227 kg (500 lbs)	272 kg (600 lbs)	292302-B22	front door, rear door, side panel	Shock pallet <sup>1</sup>

### HP Rack 5000 Series

Model	U Height	Dimensions (H x W x D)	Dynamic load	Static load	Part number	Shipped with	Shipping option
5642	42U	1983 x 586 x 1007 mm (78 x 23 x 39.6 in)	See note 2	680 kg (1500 lbs)	358254-B21	rear door, side panel	Unassembled and boxed on a pallet

<sup>1</sup> It is mandatory to use a shock pallet when shipping racks with equipment installed.

<sup>2</sup> Due to safety and stability concerns, this rack is not qualified to be shipped with equipment installed.

<sup>3</sup> Modified and preconfigured 10642 G2 rack for air duct solution (AF028A) which will be mounted at customer. Shipped including: special bottom and top panel, solid rear doors, air dams, side panels and rack rear extension.

For more information, visit [www.hp.com/products/racks](http://www.hp.com/products/racks)

# Rack options

## HP rack options

- **Thermal and cable management options** – to ensure correct airflow and cooling: filler/blanking panel, side panel kits, cable management kit, airflow optimisation kit and rack rear extension kit
- **Stabiliser and ballast kits** – increase rack stability and safety
- **Grounding kits** – optimise electrical grounding (mandatory)
- **Shelving, mounting and rail kits** – for maximum density and easy access
- **Rack options which complete the solution** – HP 2U Universal Locking Drawer, rack light kit etc.

Part number	HP rack option – description	Compatible with HP rack series			
		10000 G1	10000 G2	MCS	5642
<b>Thermal and cable management</b>					
168233-B21	Cable management D-ring Kit, 10 pack	•	•	•	•
379820-B21	HP Rack Cable Velcro Clips, 50 pack	•	•	•	•
383982-B21	Rack Top Cable Tray 600 mm, 8 pack, for 600 mm wide 10000 series racks	•	•	•	
383983-B21	Rack Top Cable Tray 800 mm, for 10842 rack	10842			
383984-B21	Rack-to-Rack Adjustable Aisle Transfer, cable bridge, for 10000 series racks	•	•		
AF099A	HP Rack Cable Management Kit – one 1U and one 2U cable management bracket, 10 D-rings, 1 cross-over bracket, 20 rack cable velcro straps/clips	•	•	•	•
AF060A	36U Rack Rear Extension Kit (155 mm) – for HP rack 10636	36U	36U		
AF036A	42U (600 mm wide) Rack Rear Extension Kit (200 mm) – for HP rack 10642 and HP MCS	42U/10642	42U/10642	•	
AF043A	47U (600 mm wide) Rack Rear Extension Kit (200 mm) – for HP rack 10647 G2	•	47U/10647	•	
257414-B21	Fan Kit 220V, 6 fans, mounted on top of the rack	•	•		
AF072A	HP 1U Universal Filler/Blanking – Panel (plastic) 10 pack	•	•	•	•
AF073A	HP 1U Universal Filler/Blanking – Panel (plastic) 100 pack	•	•	•	•
AF028A	HP 10642 G2 Top Exhaust Extension Kit Note: rack air duct kit (Rear Plenum + Rack Air Duct); BTO, for mounting at the customer	•	•		
AF029A	HP 10642 G2 Top Exhaust Field Retrofit Kit Note: rack air duct retrofit kit, not including the air duct (AF028A) but making a standard 10642 rack compatible with the air duct solution; includes: bottom panel, special top panel, solid rear doors, air dams, side panels	•	•		
AF090A	HP 10K G2 Series Rack Airflow Optimisation Kit	•	•		
<b>Shelving, mounting &amp; grounding kits</b>					
234672-B21	100 kg Sliding Shelf – Graphite, has to be combined with the suitable Rack Stabiliser Kit	•	•	•	•
253449-B21	Monitor/Utility Shelf – Graphite, 1U fixed, incl. monitor bezels (14", 15" and 17" monitor); width: 482.6 mm, depth: 739.9 mm, load capacity: 68 kg	•	•	•	•
361591-B21	HP 2U Universal Locking Drawer – Graphite	•	•	•	•
332558-B21	Depth Adjustable Fixed Rail Kit, max. 136 kg	•	•	•	•
248929-B21	10000 Rack Series Baying Kit	•	•		
248931-B21	42U 9000 to 10000 Rack Series Offset Baying Kit	•	•		
374499-B21	5000 Rack Series Baying Kit				•
AF056A	10636 G2 (36U) Side Panels (set of two) (Graphite Metallic)		36U		
AF054A	10642 G2 (42U) Side Panels (set of two) (Graphite Metallic)		42U		
AF050A	Side Panel (47U) 10000 G2 series		47U		
246099-B21	Side Panel (42U) 10000 G1 series	42U			
255486-B21	Side Panel (47U) 10000 G1 series	47U			
AF019A	HP 10636 G2 Front Door ALL	36U	36U		
AF009A	HP 10642 G2 Front Door ALL	42U/10642	42U/10642		
376440-B21	Front Door for HP Rack 5642				•
AF074A	HP 10000 G2 Rack Grounding Kit	•	•	•	
<b>Stabilisation &amp; lighting</b>					
120672-B21	Ballast option kit	•	•		•
AF062A	600 mm G2 Stabiliser* Option Kit (Graphite), for 600 mm wide for HP G2 racks		•		
AF065A	HP 10K G2 Stabiliser* 600W Hvy Dty, for 600 mm wide HP G2 racks		•		
AF066A	Stabiliser* 800 mm 10K G2 ALL		10842		
251960-B21	Plinth Kit, for HP Rack Series 10000 G1	•			
AF076A	600 mm rack tie down kit, for 600 mm wide for HP rack series 10000 G2		•		
374493-B21	Stabiliser Kit for HP Rack 5642 – Graphite Carbon				•
361589-B21	Light Kit for HP 10000 Rack Series	•	•	•	•
<b>Rack TFT monitors &amp; keyboards</b>					
AG0xxA**	HP 1U Rackmount Keyboard with touch pad and USB, new design	•	•	•	•
AG0xxA**	HP TFT7600 Rackmount Keyboard and Monitor (17" TFT), with touch pad, USB pass-through, 1U, new design	•	•	•	•

\* An anti-tip stabiliser provides stability and support when equipment is installed, removed or accessed within the rack. Heavy-duty stabiliser kits should be used when a single racked component exceeds 90 kg.

\*\* Country-specific keyboard.

For more information, visit [www.hp.com/products/rackoptions](http://www.hp.com/products/rackoptions)

## HP Modular Cooling System (MCS) G2

- **Highly efficient closed coupled cooling system** – for high-density deployments
- **Cooling capacity: up to 35 kW**
  - in single-rack configuration/35 kW
  - in two-rack configuration (two HP MCS G2 42U racks at a time)/up to 17.5 kW per rack
- **Safety features** – to prevent water contact with servers
- **Server/blade/storage deployments and access** – unaffected by design
- **Automatic door release** – for additional safety
- **Integrated remote management** – integration with HP SIM
- **Fast IT deployment** – possible to ship HP MCS and expansion rack preconfigured (ready to deploy) – shock pallet included



## HP Modular Cooling System (MCS) G2

Model	Product description	Part number	Shipped with
HP Modular Cooling System (MCS) G2	HP Modular Cooling System (MCS) G2, includes 10642 G2 rack, support for a 2nd rack (MCS G2 Expansion Rack), up to 35 kW cooling capacity (one rack config) or two times up to 17.5 kW (two rack config), 2750 CFM (4600 m <sup>3</sup> /h) of chilled air, dimensions (H x W x D): 1999.8 x 909 x 1270 mm, delivered on shock pallet (CTO capable/ready for factory integration)	AF025A	cooling rack + HP 10642 rack (42U) + sealed front and rear doors, front extension, side panel; shipped on shock pallet
HP Modular Cooling System (MCS) G2 10642 Expansion Rack	Expansion rack for HP Modular Cooling System (MCS) G2; includes special 42U HP 10642 G2 rack (sealed: front door, rear door, rack bottom plate), dimensions (H x W x D): 1999.8 x 609.6 x 1270 mm, delivered on shock pallet (CTO capable/ready for factory integration)	AF026A	rack (42U, 10642) + sealed front and rear door, sealed bottom, front extension, side panel; shipped on shock pallet
HP Modular Cooling System (MCS) Flex Hose Coupling kit	The kit contains set (two) flex hoses (3.5 metre) with flat face couplings (1 in/ 25.4 mm) and ball valve. The kit can be ordered ahead of the MCS for site preparation purposes.	AF027A	

## HP Care Packs for HP Modular Cooling System (MCS)

Model	Product description	Part number
Next Business Day Onsite Service, 5-Day x 9-Hour Coverage, 3-Year, Electronic	HP Care Pack for HP Modular Cooling System (MCS); 1-Year standard warranty	UE001E
4-Hour Onsite Service, 5-Day x 13-Hour Coverage, 3-Year, Electronic		UE002E
4-Hour Onsite Service, 7-Day x 24-Hour Coverage, 3-Year, Electronic		UE003E
6-Hour Onsite Service, 7-Day x 24-Hour Coverage, 3-Year, Electronic		UE004E
MCS G2 Onsite Installation		HP MCS Onsite Installation (includes unpackaging and power-up)

## HP Data Centre Services

Model	Product description	Part number
Site Data Centre Thermal Quick Assessment Service	Entry-level data centre cooling assessment	HB691AE

For more information, visit [www.hp.com/go/powerandcooling](http://www.hp.com/go/powerandcooling) and [www.hp.com/go/mcs](http://www.hp.com/go/mcs)



# Management – KVM solutions

## Server management with HP KVMs

- **Improved management and efficiency** – to allow centralised management, convenient access and reduced costs
- **Multi-platform management from one console** – to fit perfectly into heterogeneous environments
- **Redundant access path for HP iLO and seamless integration with HP iLO, RiLOE** – to provide secure and redundant access
- **Lower costs** – through integrated Care Pack Support for HP KVM Switches with a ProLiant Server Care Pack

## HP KVM Console Switches – Virtual Media support, three-level tiering and remote access (IP models)

Three different configuration options, showing you can connect servers to new KVM Switches. Preconditions for Virtual Media support (see options 1 and 2):

- HP KVM Console Switches and Interface Adapters (with VM support)
- New HP Interface Adapters (with VM support)
- Server (with VM support)

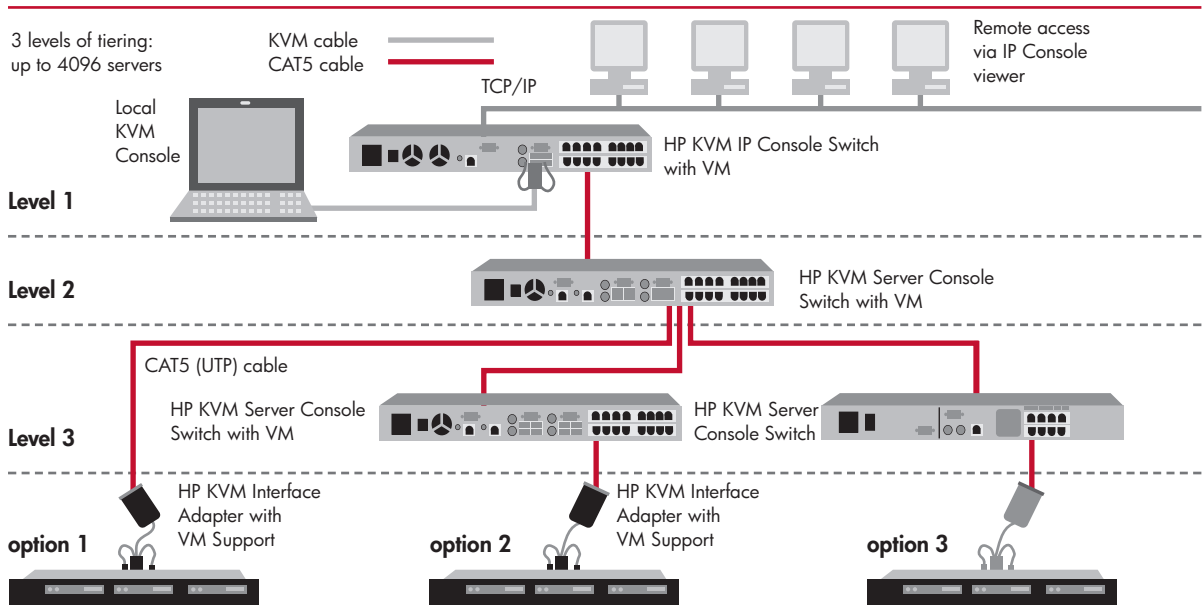

## Model comparison











Model comparison	HP KVM Server Console Switch (336044-B21, 336045-B21)	HP KVM Server Console Switch with VM (AF600A)	HP KVM IP Console Switch with VM (AF601A, AF602A)	HP Serial Console Server (AF101A, AF102A)
Number of server ports/devices (with one unit)	8 or 16	16	16	16 or 48 serial devices
Max. supported servers/devices	256 (cascaded)	up to 4096 (cascaded)	up to 4096 (cascaded)	16 or 48 serial devices
LAN/WAN access	No	No	Yes (2 or 4 users)	Yes (up to 96 users)
Number of simultaneous users (local + remote via network)	1 (local) or 2 (local)	2 (local)	3 (1+2r) or 4 (1+3r or 4r)	32 or 96 remote user (non-blocking access)
Video resolution	up to 1280 x 1024	up to 1280 x 1024	up to 1280 x 1024	Terminal emulation
Improved cable management	Yes (CAT5e, up to 30 m)	Yes (CAT5e, up to 30 m)	Yes (CAT5e, up to 30 m)	Yes (CAT5e, up to 30 m)
SNMP – manageable through HP Systems Insight Manager (SIM)	No	No	Yes (1 IP address)	Yes (1 IP address)
Multiple language support*	Yes	Yes	Yes	Yes
Multi-brand and multi-OS support	Yes	Yes	Yes	Yes
Supports different connections (PS/2, USB, Serial) for KVM	Yes – with PS/2, USB, Serial and BladeSystem Interface Adapters	Yes – with PS/2, USB, Serial and BladeSystem Interface Adapters		Serial interfaces only (different Serial Adapters available)
Supports Virtual Media (local)	No	Yes**	Yes**	No
Supports Virtual Media (remote)	No	No	Yes**	No
Tearing support (cascading level)	up to 1 level of tiering	up to 3 levels of tiering		No
Built-in tiering (cascading) port	Yes	Yes	No	No
Seamless integration with iLO, RiLOE and RiLOE II	Yes	Yes	Yes	No

\* Supports English, French, Italian, German, Spanish, Dutch and Japanese.

\*\* Yes – with PS/2 Interface Adapter with VM (via USB) support; USB Interface Adapter with VM support.

For more rack options, visit [www.hp.com/go/kvm](http://www.hp.com/go/kvm)

# Management – KVM solutions

	Model	Description	Part number
<b>HP KVM switches with conventional KVM cabling</b>			
	HP 1 x 4 Server Console Switch	1 user/4 ports; USB and PS2; 3 USB ports for additional devices; conventional KVM cabling; rackmount (rails included)	AF611A
	HP PS2 Server Console Cable, 6 foot; 2 pack	KVM Cable for HP 1 x 4 USB/PS2 KVM Switch; 6 foot; 2 pack	AF612A
	HP USB Server Console Cable, 6 foot; 2 pack	KVM Cable for HP 1 x 4 USB/PS2 KVM Switch; 6 foot; 2 pack	AF613A
<b>HP KVM server console switches (CAT5 based)</b>			
	HP KVM Server Console Switch 0 x 1 x 8 CAT5 WW	1 local user/8 ports; CAT5 cabling	336044-B21
	HP KVM Server Console Switch 0 x 2 x 16 CAT5 WW	2 local users/16 ports; CAT5 cabling	336045-B21
<b>HP KVM server console switches (CAT5 based) – with USB Virtual Media* support</b>			
	HP KVM Server Console Switch with Virtual Media*; 0 x 2 x 16 CAT5	2 local users/16 ports; local USB Virtual Media* support; CAT5 cabling	AF600A
	HP KVM IP Console Switch with Virtual Media*; 2 x 1 x 16 CAT5	2 remote users, 1 local user/16 ports; local USB Virtual Media* and remote Virtual Media* support, integrated Active Directory support (LDAP); CAT5 cabling	AF601A
	HP KVM IP Console Switch with Virtual Media*; 4 x 1 x 16 CAT5	4 remote users, 1 local user/16 ports; local USB Virtual Media* and remote Virtual Media* support, integrated Active Directory support (LDAP); CAT5 cabling	AF602A
<b>Universal components for CAT5 based HP KVM switches with Virtual Media* support</b>			
	PS/2 Virtual Media Interface Adapter; 1 pack	PS/2 KVM IF adapter with Virtual Media support via USB; NOTE: Requires PS/2 mouse and keyboard connections and 1 USB port on server	AF604A
	USB Virtual Media Interface Adapter; 1 pack	USB KVM IF adapter with Virtual Media support via USB	AF603A
<b>Universal components for CAT5 based HP KVM switches (no Virtual Media support – supports KVM only)</b>			
	HP KVM Interface Adapter PS/2-CAT5 Qty 8 WW	PS/2-RJ45/CAT5; 8 pack, NOTE: no Virtual Media support	262587-B21
	HP KVM Interface Adapter PS/2-CAT5 Qty 1 WW	PS/2-RJ45/CAT5; 1 pack, NOTE: no Virtual Media support	262588-B21
	HP KVM Interface Adapter USB-CAT5 Qty 1 WW	USB-RJ45/CAT5; 1 pack, NOTE: no Virtual Media support	336047-B21
	HP KVM Interface Adapter Serial-CAT5 Qty 1 WW	Serial (Terminal) RJ45/CAT5; 1 pack, incl. power supply, NOTE: VT100 terminal emulation	373035-B21
	HP BladeSystem CAT5 KVM Interface Adapter Qty 1 WW	HP BladeSystem p-Class SUVI/CAT5 + 1 USB, 1 pack, NOTE: supports HP BladeSystem p-Class products only, NOTE: no Virtual Media support	AF100A
	HP Blc KVM Interface Adapter	HP BladeSystem c-Class, SUVI/CAT5 + 1 USB, 1 pack, NOTE: supports HP BladeSystem c-Class products only	AF605A
<b>CAT5 UTP Cables for HP KVM switches (CAT5 based) with &amp; without VM and for HP Serial Console Server (SCS)</b>			
	CAT5e Cable 3 ft; 4 pack	CAT5e Cable 0.9 m; 4 pack	263474-B21
	CAT5e Cable 6 ft; 8 pack	CAT5e Cable 1.8 m; 8 pack	263474-B22
	CAT5e Cable 12 ft; 8 pack	CAT5e Cable 3.7 m; 8 pack	263474-B23
	CAT5e Cable 20 ft; 4 pack	CAT5e Cable 6.1 m; 4 pack	263474-B24
	CAT5e Cable 40 ft; 1 pack	CAT5e Cable 12.2 m; 1 pack	263474-B25

\* Virtual media support requires the use of Virtual Media Interface Adapters.

For more information, visit [www.hp.com/go/kvm](http://www.hp.com/go/kvm)

## Rack TFT monitors and keyboards

Model	Product description	Part number
<b>HP 1U Rackmount Keyboard with USB, touch pad and USB pass-through</b>	1U rack keyboard with touch pad and front USB <ul style="list-style-type: none"> <li>• Full-size keyboard with Windows® shortcut keys, different country-specific keyboard layouts available</li> <li>• Integrated three-button touch pad</li> <li>• USB pass-through (also available on front)</li> <li>• Tool-less universal rail kit included</li> </ul>	AG0xxA*
<b>HP TFT7600 Rackmount Keyboard and Monitor (17" TFT), with touch pad, USB pass-through, 1U</b>	1U all-in-one rack console (monitor, keyboard, touch pad), new design <ul style="list-style-type: none"> <li>• 17" TFT display (WXGA+)</li> <li>• Full-size keyboard with Windows shortcut keys, different country-specific keyboard layouts available</li> <li>• Integrated three-button touch pad</li> <li>• USB pass-through (also available on front)</li> <li>• Tool-less universal rail kit included</li> </ul>	
	TFT7600 Rackmount Keyboard and Monitor US	AG052A
	TFT7600 Rackmount Keyboard and Monitor UK	AG053A
	TFT7600 Rackmount Keyboard and Monitor GR	AG054A
	TFT7600 Rackmount Keyboard and Monitor FR	AG055A
	TFT7600 Rackmount Keyboard and Monitor IT	AG056A
	TFT7600 Rackmount Keyboard and Monitor SP	AG057A
	TFT7600 Rackmount Keyboard and Monitor DEN	AG058A
	TFT7600 Rackmount Keyboard and Monitor NOR	AG059A
	TFT7600 Rackmount Keyboard and Monitor SE/FI	AG060A
	TFT7600 Rackmount Keyboard and Monitor SWI	AG061A
	TFT7600 Rackmount Keyboard and Monitor PORT	AG062A
	TFT7600 Rackmount Keyboard and Monitor BEL	AG063A
	TFT7600 Rackmount Keyboard and Monitor JPN2	AG064A
	TFT7600 Rackmount Keyboard and Monitor RUS	AG065A
	TFT7600 Rackmount Keyboard and Monitor intl	AG066A

\* Refers to country-specific keyboard.



TFT 7600 RKM



1U Rackmount Keyboard

## Serial console

### HP Serial Console Server/SCS (CAT5 based)



	Model	Description	Part number
<b>HP Serial Console Server/SCS (CAT5 based)</b>	HP 16-Port Serial Console Server	Serial over IP for up to 16 serial devices (16 ports) non-blocking remote access, one local serial port	AF101A
	HP 48-Port Serial Console Server	Serial over IP for up to 48 serial devices (48 ports) non-blocking remote access, one local serial port	AF102A
<b>Serial Adapters for HP Serial Console Server/SCS (CAT5 based)</b>	Serial Adapter, RJ45-DB9 DCE Female; 1 pack	Serial Adapter, RJ45-DB9 DCE Female; 1 pack	AF103A
	Serial Adapter, RJ45-DB9 DTE Male; 1 pack	Serial Adapter, RJ45-DB9 DTE Male; 1 pack	AF105A
	Serial Adapter, RJ45-DB25 DCE Male; 1 pack	Serial Adapter, RJ45-DB25 DCE Male; 1 pack	AF106A
	Serial Adapter, CAT5 RJ45-DB25 DTE Male; 1 pack	Serial Adapter, CAT5 RJ45-DB25 DTE Male; 1 pack	AF107A
	Serial Adapter, CAT5 RJ45-DB25 DCE Female; 1 pack	Serial Adapter, CAT5 RJ45-DB25 DCE Female; 1 pack	AF108A
	Serial Adapter, CAT5 RJ45-DB25 DTE Female; 1 pack	Serial Adapter, CAT5 RJ45-DB25 DTE Female; 1 pack	AF109A
	Serial Adapter, RJ45-DB9 DCE Female; 8 pack	Serial Adapter, RJ45-DB9 DCE Female; 8 pack	AF110A
	Serial Adapter, RJ45 for Cisco; 1 pack	Serial Adapter, RJ45 for Cisco; 1 pack	AF104A

# UPS solutions – 1 Phase – Tower

## HP Tower UPS

- **UPS capacity** – from 500 W to 1600 W (real power)
- **Patented Enhanced Battery Management (EBM)** – doubles battery life up to 6 years
- **60-day battery** – pre-failure warning and 3-year backup warranty
- **Extended Runtime Modules (ERMs)** – increase UPS backup time by need (optional)
- **Hot-swap battery modules** – provide highest availability
- **Integrated Care Pack Support** – HP Server & Storage Server Care Pack support of HP UPSs up to 12 kVA at no additional cost



## Tower UPS models

Model	T750 G2 Intl	T1000 G3 Intl	T1500 G3 Intl	R/T2200 G2 Intl
Part number	AF447A	AF449A	AF451A	AF411A
Form factor	Tower	Tower	Tower	Tower/Rack
Power output	750 VA 500 W	1000 VA 670 W	1500 VA 950 W	2200 VA 1600 W
Backup time at 80% load <sup>1</sup>	6 mins <sup>2</sup>	6 mins <sup>2</sup>	6 mins <sup>2</sup>	8.5 mins <sup>2</sup>
Load segments	1	1	1	4
Output (high-voltage model)	4 x IEC320 C13	6 x IEC320 C13 (10A)		8 x IEC320 C13 (10A)
Hot-swap batteries	Yes	Yes	Yes	Yes
Weight (kg)	12.7	12.7	17	27.2
Optional ERM/part number	N/A	N/A	N/A	1/AF412A
Communication	USB/serial; includes HP Power Management software			
Warranty	3-year HP warranty (3-1-1), HP battery pre-failure warranty and integrated Care Pack Support at no additional cost <sup>3</sup>			

<sup>1</sup> Backup times are estimated for typical applications at recommended load level of 80%. Actual performance will depend on environment conditions, ambient temperature, battery age and other factors.

<sup>2</sup> Increased system uptime possible with optional Extended Runtime Modules (ERMs).

<sup>3</sup> HP Server and Storage Care Pack also supports HP UPSs up to 12 kVA at no additional cost.

## UPS options

Model	Description	For which HP UPS	Part number
HP ERM R/T2200 2U Battery	UPS Expansion Runtime Module (extended battery) – extends backup time	R/T2200 G2	AF412A

## Power cords

Model	Description	Part number
Pwr Crd Kt, 1.83 m, 10A, C13-ISRAEL	Pwr Crd Kt, 1.83 m, 10A, C13-ISRAEL/SI32	AF564A
Pwr Crd Kt, 1.83 m, 10A, C13-SWISS	Pwr Crd Kt, 1.83 m, 10A, C13-SWISS/SEV 1011	AF565A
Pwr Crd Kt, 1.83 m, 10A, C13-DANISH	Pwr Crd Kt, 1.83 m, 10A, C13-DANISH/DK 2-5A	AF566A
Pwr Crd Kt, 2.5 m, 10A, C13-S.AFRICAN	Pwr Crd Kt, 2.5 m, 10A, C13-S.AFRICAN/SABS 164	AF567A
Pwr Crd Kt, 1.83 m, 10A, C13-EURO	Pwr Crd Kt, 1.83 m, 10A, C13-EURO/IEC83 C4 (CEE7-VII)/Schuko	AF568A
Pwr Crd Kt, 1.83 m, 10A, C13-UK/HK/SINGAPORE	Pwr Crd Kt, 1.83 m, 10A, C13-UK/HK/SINGAPORE	AF570A
Pwr Crd Kt, 1.83 m, 10A, C13-ITALY/CHILE	Pwr Crd Kt, 1.83 m, 10A, C13-ITALY/CHILE/CEI 23-50	AF571A

# UPS solutions – 1 Phase – Rack

## HP Rack UPS – 1Phase

- **UPS capacity** – from 1000 W to 5400 W (real power)
- **Patented Enhanced Battery Management (EBM)** – doubles battery life up to 6 years
- **60-day battery** – pre-failure warning and 3-year backup warranty
- **Extended Runtime Modules (ERMs)** – increase UPS backup time by need (optional)
- **Load segmentation** – optimises configuration flexibility and shutdown priority
- **Hot-swap battery modules** – and electronics provide highest availability
- **Integrated Care Pack Support** – HP Server and Storage Care Pack support of HP UPSs up to 12 kVA at no additional cost

## Rackmount UPS models



Model	R/T2200 G2 Intl	R1500 G2 Intl	R3000 Intl	R5500 Intl
Part number	AF411A	AF418A	AF414A	AF416A
Form factor	Tower/Rack/2U	Rack/1U	Rack/2U	Rack/3U
Power output	2200 VA 1600 W	1500 VA 1000 W	3000 VA 2700 W	6000 VA 5400 W
Backup time at 80% load <sup>1</sup>	8.5 mins	8 mins	6 mins	9 mins
Load segments	4	2	3	2
Output (high-voltage model)	8 x IEC320 C13 (10A)	4 x IEC320 C13	1 x IEC320 C19 (16A) 9 x IEC320 C13 (10A)	4 x IEC320 C19 4 x IEC320 C13 (10A) 1 x IEC309 (32A)
Hot-swap batteries	Yes	Yes	Yes	Yes
Weight (kg)	27.2	23	37	68
Optional ERM/part number	1/AF412A	N/A	1/AF415A	1/AF417A
Communication	USB/serial	serial (RS-232/DB9); more options available (see “UPS options”)		
Communication software	includes HP Power Manager software			
Warranty	3-year HP warranty (3-1-1), HP battery pre-failure warranty and integrated Care Pack Support at no additional cost <sup>3</sup>			

## UPS options



Model	Description	For which HP UPS	Part number
HP UPS Management Module	UPS management card with one ethernet port and five serial ports (R45); embedded management software with communication and management functions: <ul style="list-style-type: none"> <li>• Allows up to five servers to communicate direct via serial connection and to ethernet (to servers and for remote access)</li> <li>• Redundant UPS support</li> </ul>	HP UPS R1500 G2, R3000, HP UPS R5500 and former HP XR models; this module is included with R8000/3, R12000/3 and RP36000/3 For further info, see quick specs	AF401A <sup>4</sup>
HP Srl Adptr RJ45-DB9 DCE Female 5pk	Serial Adapters RJ45 to DB9 DCE, for the new HP Management Card (AF401A); 5 pack	for HP UPS Management Module (AF401A)	AF402A

<sup>1</sup> Backup times are estimated for typical applications at recommended load level of 80%. Actual performance will depend on environment conditions, ambient temperature, battery age and other factors. Increased system uptime possible with optional Extended Runtime Modules (ERMs).

<sup>2</sup> Delivered incl. 4 rack PDU sticks (7 x C13 outlets each); these can be connected to the C19s on the UPS unit and provide up to 28 IEC320 C13 outputs in addition to the 4 on the unit.

<sup>3</sup> HP Server and Storage Care Pack also supports HP UPSs up to 12 kVA at no additional cost.

<sup>4</sup> Replaces SNMP/serial card (AF427A) and Six-port card (AF428A).

**NOTE:** All our products are RoHS compliant.

If you need help sizing your HP Rack and Power infrastructure solution (Rack, Rack options, UPS, PDU, KVM), please go to [www.hprackandpowersizer.com](http://www.hprackandpowersizer.com)

For more UPS options, information on HP power products and software downloads, please visit [www.hp.com/products/ups](http://www.hp.com/products/ups)

# 3Phase power solutions (UPS, PDR)

## HP 3Phase power solutions

New zoned power approach with power protection and power distribution for zone/rack row level

- **Adding power protection** and distribution capacity when and where needed
- **Getting the reliability** of large central systems in a rack footprint
- **Enable adding capacity** to otherwise full data centres
- **High energy-efficiency** (97% efficient)

## HP 3Phase UPS solutions – 3Phase UPS modules and Parallel UPS (preconfigured UPS Rack)

- **UPS modules** with 8 kVA and 12 kVA capacity
- **Parallel UPS** with 36 kVA capacity – scalable up to 60 kVA in a single 19" rack
- **High-density design**, lightweight, hot-swappable battery and electronics modules
- **Intelligent automated maintenance bypass** in each UPS module/chassis
- **Integrated Care Pack Support** for the single Rack UPS modules (R8000/3 and R12000/3) – HP Server and Storage Care Pack supports HP UPSs up to 12 kVA at no additional cost



HP 3Phase UPS Modules (Rackmount)		
Model	R8000/3 Intl	R12000/3 Intl
Part number	AF432A	AF430A
Form factor	Rack module/6U	Rack module/6U
INput power	400 V 3phase	400 V 3phase
INput connections (INTL model)	1 x IEC 309 16A (3phase power)	1 x IEC 309 32A (3phase power)
OUTput power rating/capacity	8 kVA/8 kW; 400 V 3phase	12 kVA/12 kW; 400 V 3phase
OUTput connections (INTL model)	1 x IEC 309 16A (3phase power)	2 x IEC 309 16A (3phase power) = UPS output module (AF434A)
Backup time at 80% load <sup>1</sup>	12 mins	6 mins
Hot-swap electronic modules & batteries	Yes	Yes
Weight (kg)	140	140
Optional ERM/part number	max. 4/AF434A	max. 4/AF434A
Communication	HP UPS Management module (AF401A) included; module with one ethernet port and five serial ports (RJ45)	
Communication software	Embedded HP Power Management software on HP UPS Management module (AF401A)	
Warranty	3-Year HP warranty (3-1-1), HP battery pre-failure warranty and integrated Care Pack Support at no additional cost	



HP 3Phase Parallel UPS (preconfigured Rack & module)		
Model	RP36000/3 Intl	RP12000/3 Intl
Description	Preconfigured parallel rack UPS Rack 42U with three UPS modules and power bar	Additional 12 kVA UPS module for RP36000/3 (to be added into the parallel rack UPS (RP36000/3))
Part number	AF439A	AF437A
Form factor	Rack 42U (HP 10000 Series G2, 10642)	Rack module/6U
INput power	400 V 3phase	400 V 3phase
INput connections (intl model)	Hard wire terminal	to power bus bar (on RP36000/3)
OUTput power rating/capacity	non-redundant: 36 kVA/36 kW n+1 redundant: 24 kVA/24 kW – expandable up to 60 kVA (n+1)	12 kVA/12 kW; 400 V 3phase
OUTput connections (intl model)	Hard wire terminal; Optional (add on): HP R12000/3 Intl UPS Output Module (AF441A)	Connector to power bus bar (on RP36000/3) or optional: UPS output module (AF441A)
INput power	400 V 3Phase	400 V 3Phase
INput connections (intl model)	1 x IEC309 16A (3Phase power)	1 x IEC309 32A (3Phase power)
Backup time at 80% load <sup>1</sup>	12 mins	6 mins
Hot-swap electronic modules & batteries	Yes	Yes
Weight (kg)	578	140
Optional ERM/part number	AF434A	max. 4/AF434A
Communication	HP UPS Management module (AF401A) included; module with one ethernet port and five serial ports (RJ45)	
Communication software	Embedded HP Power Management software on HP UPS Management module (AF401A)	
Warranty	3-Year HP warranty (3-1-1), HP battery pre-failure warranty	

## UPS options – for HP 3Phase Rack and Parallel UPS

Model	Description	For which HP UPS	Part number
HP R12000/3 intl UPS Output Module	Rackmount UPS Output Module, with 2 x IEC309 16A connectors (3Phase)	RP12000/3 (this module is included with R12000/3)	AF441A
HP 3Phase UPS ERM Module	UPS Expansion Runtime Module (extended battery) 3U extends backup time up to four (4) ERMs per UPS	R8000/3 R12000/3 RP36000/3 RP12000/3	AF434A
HP 3Phase 16A intl Mod PDU, Core unit	Core unit only, input: 3Phase, IEC309 16A 4Pin, attached input cord, connects into 3Phase facility input or to a 3Phase UPS; Output: 6 x IEC320 C19 (single phase)	R8000/3 R12000/3	AF513A
HP 11 kVA S1316 Monitored PDU (intl)	Single input, 3Phase, 16A, intl Input: 1 x IEC309, 5Pin 16A Output: 39/36 C13 (10A) plus 3 C19 (16A)	R8000/3 R12000/3	AF508A
HP 22 kVA S2316 Monitored PDU (intl)	Dual input, 3Phase, 16A, intl Input: 2 x IEC309, 5Pin 16A Output: 78/72 (2 x 36) C13 (10A) plus 6 (2 x 3) C19	R12000/3 RP12000/3 and 36000/3 – with additional UPS output module (option)	AF507A

## Power cords/Jumper cables

Model	Description	Part number
HP 5' IEC309 516P intl Jumper Cable	Power Cord – Jumper Cable IEC309 16A, 5Pin 1.65 m	460153-005
HP 10' IEC309 516P intl Jumper Cable	Power Cord – Jumper Cable IEC309 16A, 5Pin 3.3 m	460153-010
HP 15' IEC309 516P intl Jumper Cable	Power Cord – Jumper Cable IEC309 16A, 5Pin 4.95 m	460153-015

## Power distribution rack (PDR)

New decentralised power distribution on rack row level (using a single industry standard rack)

- **Allows shorter, smaller cable runs** – increases airflow, uses less cooling power and improves ROI
- **Preconfigured power cables (whips)** – save installation labour and improve change management
- **Fully redundant, dual high amperage inputs and outputs** – up to 2 x 200 A/2 x 138 kVA
- **Input options** – facility power, facility UPS, HP 3Phase Parallel UPS
- **Output options** – capable of mixing high voltage and 3Phase outputs, short preconfigured whips from PDR to racks/rack PDUs
- **Improved power monitoring** – individual branch circuit monitoring
- **Independent surge suppression** – dual transient voltage surge suppression (TVSS)

### HP Power Distribution Rack (PDR)

Model	Description	Part number
HP Power Distribution Rack, intl	200 Amp Dual Input Power Distribution Rack, intl	AF515A
<b>Related options</b>		
Circuit breakers (intl)	For further info, see quick specs	
Preconfigured power cabling (intl)		
Startup and commissioning service		



For more information, visit [www.hp.com/go/pdr](http://www.hp.com/go/pdr)

# PDU solutions

## HP Modular Power Distribution Units (mPDUs)

- **Power input** – single input with 3Phase or 1Phase power
- **Modular architecture** – based on one PDU control unit and extension bars (for details see diagram below)
- **Density optimised 1U/OU rackmount design** – incl. mounting brackets
- **Integrated Care Pack support** – HP Server and Storage Care Pack supports HP PDUs at no additional cost

## HP mPDUs

Model	Description	Outputs	Part number
16A mPDU (worldwide)	Core unit and 2 extension bars, input: IEC309 C20, connects into facility input or high-voltage UPS R3000, R5500	14 (2 x 7) IEC320 C13 (10A)	252663-B24
32A mPDU (international)	Core unit and 4 extension bars, input: IEC309 32A, connects into facility input or R5500	28 (4 x 7) IEC320 C13 (10A)	252663-B31
40A mPDU (worldwide)	Core unit and 4 extension bars; can be hard-wired directly into facility input or to a high-voltage UPS	25; 21 (3 x 7) IEC320 C13 (10A), 4 x IEC320 C19 (16A)	252663-B21
40A mPDU (international)	Core unit and 4 extension bars, input: IEC309 63A, can be connected directly into facility input or to a high-voltage UPS	25; 21 (3 x 7) IEC320 C13 (10A), 4 x IEC320 C19 (16A)	252663-B32
Core only 32A (intl)	Core unit only, input: IEC309 32A, connects into facility input or R5500	4 x IEC320 C19	252663-B33
Core only 40A (intl)	Core unit only, input: IEC309 63A 3Pin, attached input cord, connects into facility input or to a high-voltage UPS	4 x IEC320 C19	252663-B34
Core only, HP 3Phase 16A intl Mod PDU	Core unit only, input: 3Phase, IEC309 16A 4Pin, attached input cord, connects into 3Phase facility input or to a 3Phase UPS	6 x IEC320 C19	AF513A
Fixed-cord extension bar kits	2 PDU extension bars with 7 fixed and short cables (33 cm) Input: C20	2 x 7 IEC320 C13	351655-B21
2 C13 PDU Extension bars	2 PDU extension bars with 7 receptacles (C13) Input: C20	14/2 x 7 C13 (10A)	AF500A
3rd-party mPDU mounting kit	3rd-party mPDU mounting kit (worldwide)		310777-B21
1.6' IEC C13-C14 PDU cable (x 1)	10A, IEC320 C14 to IEC320 C13 Cable; 1.6 ft/0.5 m 1 pc		142257-B28
4.5' IEC C13-C14 PDU cable (x 1)	10A, IEC320 C14 to IEC320 C13 Cable; 4.5 ft/1.37 m 1 pc		142257-006
4.5' IEC C13-C14 PDU cable (x 15)	10A, IEC320 C14 to IEC320 C13 Cable; 4.5 ft/1.37 m 15 pcs		142257-007
8' IEC C13-C14 PDU cable (x 1)	10A, IEC320 C14 to IEC320 C13 Cable; 8 ft/2.5 m 1 pc		142257-002
10' IEC C13-C14 PDU cable (x 1)	10A, IEC320 C14 to IEC320 C13 Cable; 10 ft/3 m 1 pc		142257-003



Side view of HP rack with modular PDU mounted in OU (on side)

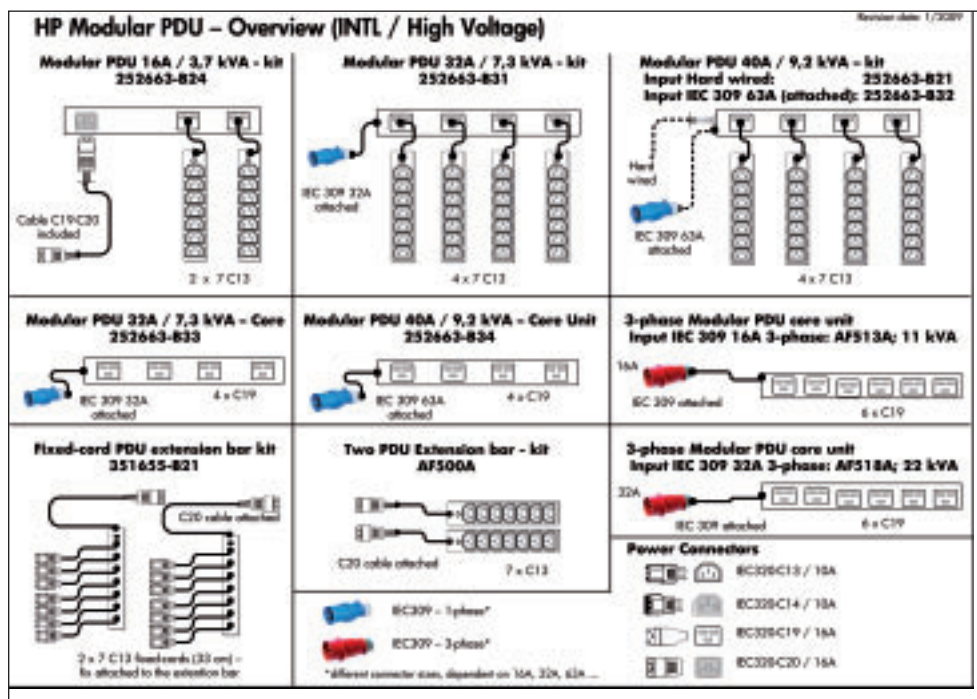



## HP Power Distribution Unit (PDU) with power monitoring

- **Power input** – single and dual input models with 3Phase or 1Phase power
- **Density-optimised 0U rackmount design** (vertical in the back of the rack) – incl. mounting brackets
- **Local power** – monitoring display and optional remote power reporting
- **Unique colour-coded load identification** and circuit breaker per load segment
- **Mounting and cord retention brackets** – for rackmounting included
- **Integrated Care Pack support** – HP Server and Storage Care Pack supports HP PDUs at no additional cost

## HP monitored PDUs

Model	Description	Outlets	Part number
<b>HP 22 kVA S2316 Monitored PDU (intl)</b>	Dual input, 3Phase, 16A, intl Input: 2 x IEC309, 5Pin 16A	78/72 (2 x 36) C13 (10A) plus 6 (2 x 3) C19	AF507A
<b>HP 11 kVA S1316 Monitored PDU (intl)</b>	Single input, 3Phase, 16A, intl Input: 1 x IEC309, 5Pin 16A	39/36 C13 (10A) plus 3 C19 (16A)	AF508A
<b>HP 14.7 kVA S2132 Monitored PDU (intl)</b>	Dual input, 1Phase, 32A, intl Input: 2 x IEC309, 3Pin 32A	78/72 (2 x 36) C13 (10A) plus 6 (2 x 3) C19 (16A)	AF509A
<b>HP 7.4 kVA S1132 Monitored PDU (intl)</b>	Single input, 1Phase, 32A, intl Input: 2 x IEC309, 3Pin 32A	39/36 C13 (10A) plus 3 C19 (16A)	AF510A
<b>HP 7.3 kVA S132 Monitored PDU (intl)</b>	Single input, 1Phase, 32A, intl Input: 1 x IEC309, 3Pin 32A, flat enclosure	27/24 C13 (10A) plus 3 C19 (16A)	AF915A
<b>HP 22 kVA S1332 Monitored PDU (intl)</b>	Single input, 3Phase, 32A, intl Input: 1 x IEC309, 5Pin, 32A	12 C19 (16A)	AF917A
<b>HP PDU management module</b>	Hot-plug retrofit option for all HP-monitored PDUs. Embedded software, remote power monitoring and PDU management via ethernet.	Ethernet (RJ45), Serial (DB9)	AF400A
<b>2 C13 PDU extension bars</b>	2 PDU extension bars with 7 receptacles (C13) Input: C20	14/2 x 7 C13 (10A)	AF500A
<b>Fixed-cord extension bar kit</b>	2 PDU extension bars with 7 fixed and short cables (33 cm) Input: C20	2 x 7 IEC320 C13	351655-B21

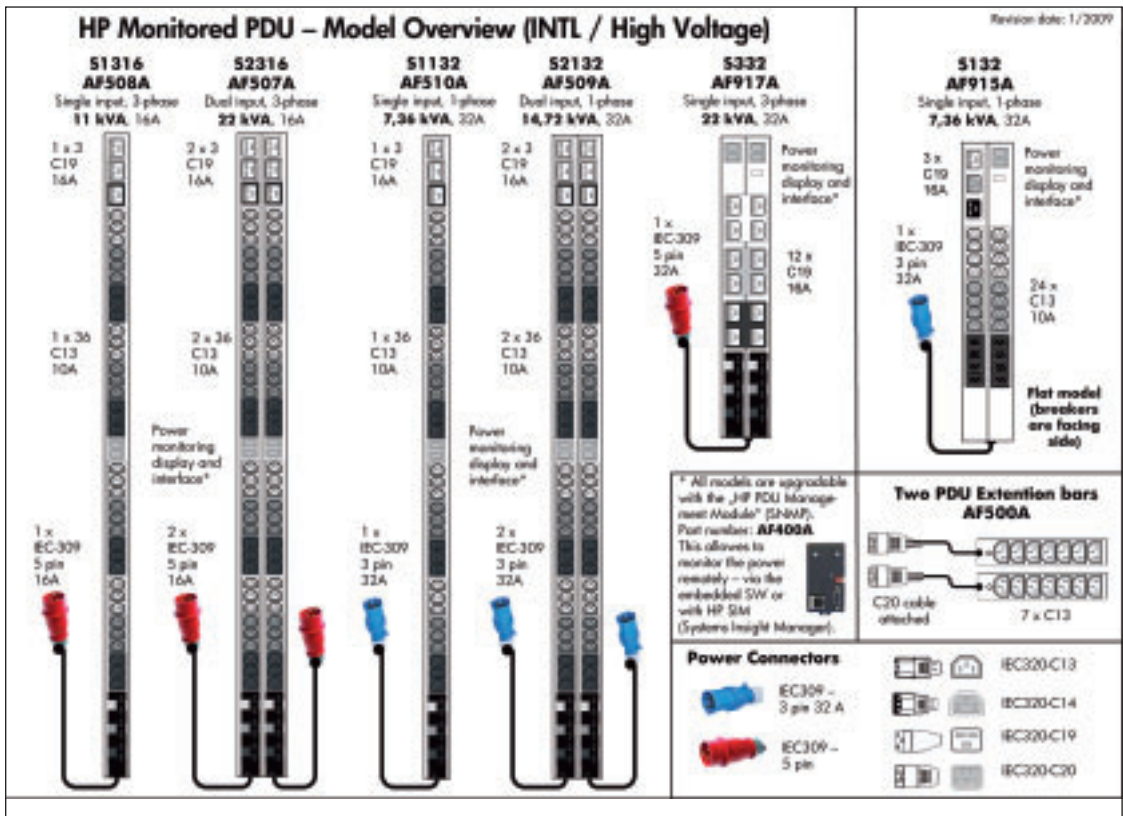

For more PDU options, information on HP power products and software downloads, please visit [www.hp.com/products/ups](http://www.hp.com/products/ups)

# HP Factory Express Services

## Customisation, integration and deployment services from the HP Factory to the data centre that save you time, money and resources

With HP Factory Express Services, you can:

- Collaborate with HP experts thereby freeing up your IT resources to deliver other strategic value for your business
- Choose how your solution is built, tested, integrated, shipped and deployed
- Receive ready-to-deploy solutions delivered consistently worldwide

HP Factory Express Services are a perfect fit for your Rack & Power solution since they enable pre-delivery customisation and integration, ensuring you receive a total solution that is ready to go.

### HP Factory Express System Customisation Services

Tell us how you want your system built, racked, labelled and cabled. HP offers:

- Custom system settings
- Hardware and rack integration
- Asset & RFID tagging and labelling
- Special packaging – and more!

### HP Factory Express Logistic Services

HP can create a custom delivery experience to accommodate your site constraints and project needs.

HP offers:

- Delivery at your site directly to the data centre
- Special equipment to transport heavy racked items
- Unpacking and waste removal
- Non-working day/time delivery
- Consolidation of your orders ensuring one delivery

### HP Factory Express Software Image Management Services

By leveraging HP engineering to load and manage your software image at our factory, we can help reduce your installation time. HP offers:

- Image development and qualification
- Image loading
- Image recovery

### HP Factory Express Solution Services

For complex project rollout and end-to-end support for ease of implementation, HP offers additional value-added services:

- Project management
- Onsite setup and turn-on
- Engineering consultation, support and training

For more information, visit [www.hp.com/go/factoryexpress](http://www.hp.com/go/factoryexpress)

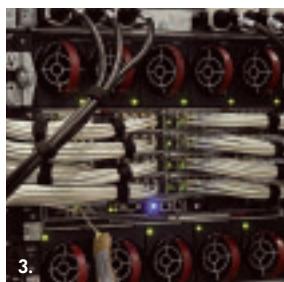

1. Complete system documentation
2. Rack integration up to cluster solutions across multiple racks
3. Best-in-class cable management and airflow
4. Almost ready to go, awaiting final packaging



# Synergy and integration is the difference

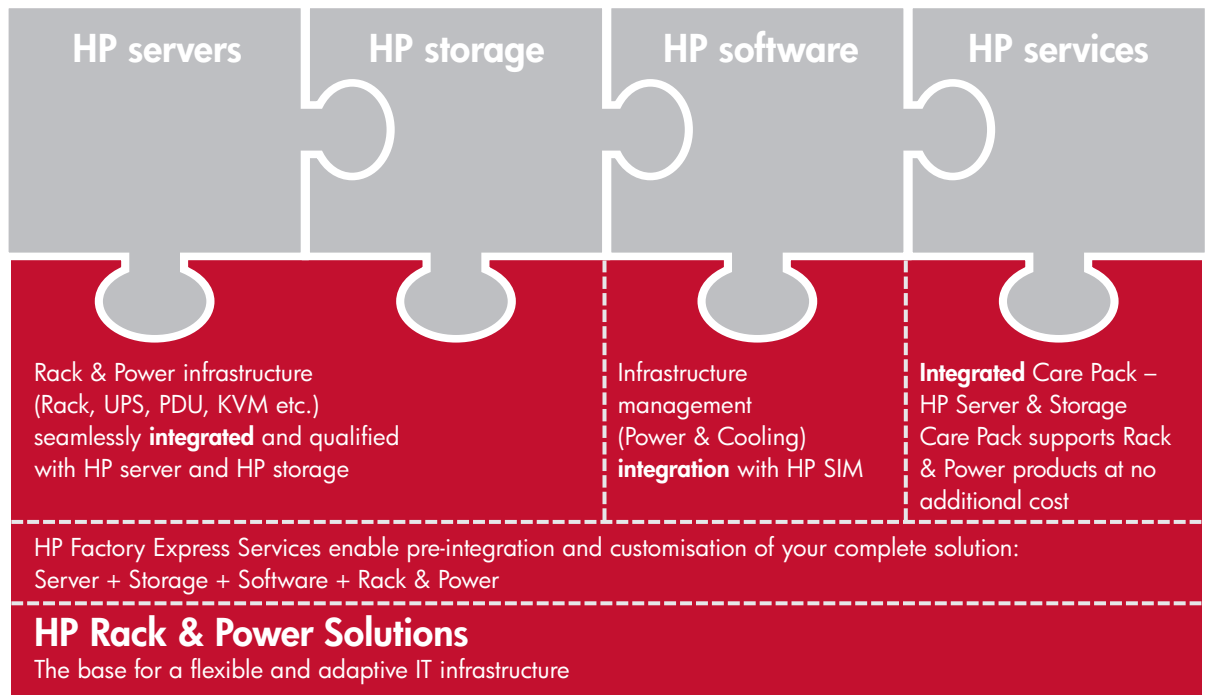

## Energy-efficient computing in the next-generation data centre

HP: Taking a holistic approach to power and cooling issues, from end to end – from Chip to Chiller. HP Rack & Power Solutions are part of HP's end-to-end solution, and important if you want to create an energy-efficient data centre.

### Made for HP, by HP

HP Rack & Power Solutions are qualified for seamless integration with HP ProLiant and Integrity servers, HP-UX-based servers and HP storage offerings, as well as standards-based third-party solutions.

We give you a one-stop shop for your entire solution – simplifying product and vendor qualifications, procurement and customer support, and guaranteeing product compatibility.

### HP Rack & Power Solutions – product groups

- Racks and rack options – to provide the base for a flexible, adaptive IT infrastructure
- Power – to protect, distribute and monitor the power
- Access and monitoring – to harmonise the management of heterogeneous servers, storage and IT infrastructure
- Cooling – to handle the increased heat on the rack and data centre level

You can find out more by referring to the HP Rack & Power Solutions toolkit, or by visiting us online at: [www.hp.com/go/rackandpower](http://www.hp.com/go/rackandpower)  
[www.hp.com/eur/rackandpower](http://www.hp.com/eur/rackandpower)

For specific queries, please contact us at: [rackandpowersolutions@hp.com](mailto:rackandpowersolutions@hp.com)

© Copyright 2009 Hewlett-Packard Development Company, L.P. The information contained herein is subject to change without notice. The only warranties for HP products and services are set forth in the express warranty statements accompanying such products and services. Nothing herein should be construed as constituting an additional warranty. HP shall not be liable for technical or editorial errors or omissions contained herein. Windows is a trademark of the Microsoft group of companies.

4AA2-5078EEE. March 2009



Technology for better business outcomes