

**SUPER** ●<sup>®</sup>

**C9X299-PGF**  
**C9X299-RPGF**

**USER'S MANUAL**

**Revision 1.0a**

---

---

The information in this User's Manual has been carefully reviewed and is believed to be accurate. The vendor assumes no responsibility for any inaccuracies that may be contained in this document, makes no commitment to update or to keep current the information in this manual, or to notify any person or organization of the updates. **Please Note: For the most up-to-date version of this manual, please see our website at [www.supermicro.com](http://www.supermicro.com).**

Super Micro Computer, Inc. ("Supermicro") reserves the right to make changes to the product described in this manual at any time and without notice. This product, including software and documentation, is the property of Supermicro and/or its licensors, and is supplied only under a license. Any use or reproduction of this product is not allowed, except as expressly permitted by the terms of said license.

**IN NO EVENT WILL SUPERMICRO BE LIABLE FOR DIRECT, INDIRECT, SPECIAL, INCIDENTAL, SPECULATIVE OR CONSEQUENTIAL DAMAGES ARISING FROM THE USE OR INABILITY TO USE THIS PRODUCT OR DOCUMENTATION, EVEN IF ADVISED OF THE POSSIBILITY OF SUCH DAMAGES. IN PARTICULAR, SUPERMICRO SHALL NOT HAVE LIABILITY FOR ANY HARDWARE, SOFTWARE, OR DATA STORED OR USED WITH THE PRODUCT, INCLUDING THE COSTS OF REPAIRING, REPLACING, INTEGRATING, INSTALLING OR RECOVERING SUCH HARDWARE, SOFTWARE, OR DATA.**

Any disputes arising between manufacturer and customer shall be governed by the laws of Santa Clara County in the State of California, USA. The State of California, County of Santa Clara shall be the exclusive venue for the resolution of any such disputes. Super Micro's total liability for all claims will not exceed the price paid for the hardware product.

FCC Statement: This equipment has been tested and found to comply with the limits for a class B digital device, pursuant to Part 15 of the FCC Rules. These limits are designed to provide reasonable protection against harmful interference in a residential installation. This equipment generates, uses, and can radiate radio frequency energy and, if not installed and used in accordance with the instructions, may cause harmful interference to radio communications. However, there is no guarantee that interference will not occur in a particular installation. If this equipment does cause harmful interference to radio or television reception, which can be determined by turning the equipment off and on, the user is encouraged to try to correct the interference by one or more of the following measures:

- Reorient or relocate the receiving antenna.
- Increase the separation between the equipment and receiver.
- Connect the equipment to an outlet on a circuit different from that to which the receiver is connected.
- Consult the authorized dealer or an experienced radio/TV technician for help.

California Best Management Practices Regulations for Perchlorate Materials: This Perchlorate warning applies only to products containing CR (Manganese Dioxide) Lithium coin cells. "Perchlorate Material-special handling may apply. See [www.dtsc.ca.gov/hazardouswaste/perchlorate](http://www.dtsc.ca.gov/hazardouswaste/perchlorate)"



**WARNING:** This product can expose you to chemicals including lead, known to the State of California to cause cancer and birth defects or other reproductive harm. For more information, go to [www.P65Warnings.ca.gov](http://www.P65Warnings.ca.gov).

Manual Revision: 1.0a

Release Date: April 24, 2018

Unless you request and receive written permission from Super Micro Computer, Inc., you may not copy any part of this document.

Information in this document is subject to change without notice. Other products and companies referred to herein are trademarks or registered trademarks of their respective companies or mark holders.

Copyright © 2018 by Super Micro Computer, Inc. All rights reserved.

**Printed in the United States of America**

## Preface

This manual is written for system integrators, PC technicians and knowledgeable PC users. It provides information for the installation and use of the **SUPER** C9X299-PGF/-RPGF motherboard.

### Manual Organization

**Chapter 1** describes the features, specifications and performance of the motherboard, and provides detailed information on the Intel X299 chipset.

**Chapter 2** provides hardware installation instructions. Read this chapter when installing the processor, memory modules and other hardware components into the system.

**Chapter 3** describes troubleshooting procedures for video, memory and system setup stored in the CMOS.

**Chapter 4** includes an introduction to the BIOS, and provides detailed information on running the CMOS Setup utility.

**Appendix A** provides BIOS Error Beep Codes.

**Appendix B** lists software program installation instructions.

**Appendix C** contains UEFI BIOS Recovery instructions.

## Checklist

Congratulations on purchasing your computer motherboard from an acknowledged leader in the industry. Supermicro boards are designed with the utmost attention to detail to provide you with the highest standards in quality and performance.

Please check that the following items have all been included with your motherboard. If anything listed here is damaged or missing, contact your retailer.

The following items are included in the retail box:

- One (1) Supermicro Motherboard
- Four (4) SATA cables
- One (1) I/O shield
- One (1) Quick Reference Guide
- One (1) Driver CD

## Conventions Used in the Manual

Special attention should be given to the following symbols for proper installation and to prevent damage done to the components or injury to yourself:



**Attention!** Critical information to prevent damage to the components or injury to yourself.



**Important:** Important information given to ensure proper system installation or to relay safety precautions.



**Note:** Additional Information given to differentiate various models or provides information for correct system setup.

## Standardized Warning Statements

The following statements are industry-standard warnings, provided to warn the user of situations which have the potential for bodily injury. Should you have questions or experience difficulty, contact Supermicro's Technical Support department for assistance. Only certified technicians should attempt to install or configure components.

Read this section in its entirety before installing or configuring components in the Supermicro chassis.

### Battery Handling



#### Warning!

There is a danger of explosion if the battery is replaced incorrectly. Replace the battery only with the same or equivalent type recommended by the manufacturer. Dispose of used batteries according to the manufacturer's instructions

電池の取り扱い

電池交換が正しく行われなかった場合、破裂の危険性があります。交換する電池はメーカーが推奨する型、または同等のものを使用下さい。使用済電池は製造元の指示に従って処分して下さい。

#### 警告

電池更換不當會有爆炸危險。請只使用同類電池或製造商推薦的功能相當的電池更換原有電池。請按製造商的說明處理廢舊電池。

#### 警告

電池更換不當會有爆炸危險。請使用製造商建議之相同或功能相當的電池更換原有電池。請按照製造商的說明指示處理廢棄舊電池。

#### Warnung

Bei Einsetzen einer falschen Batterie besteht Explosionsgefahr. Ersetzen Sie die Batterie nur durch den gleichen oder vom Hersteller empfohlenen Batterietyp. Entsorgen Sie die benutzten Batterien nach den Anweisungen des Herstellers.

#### Attention

Danger d'explosion si la pile n'est pas remplacée correctement. Ne la remplacer que par une pile de type semblable ou équivalent, recommandée par le fabricant. Jeter les piles usagées conformément aux instructions du fabricant.

## iAdvertencia!

Existe peligro de explosión si la batería se reemplaza de manera incorrecta. Reemplazar la batería exclusivamente con el mismo tipo o el equivalente recomendado por el fabricante. Desechar las baterías gastadas según las instrucciones del fabricante.

## אזהרה!

קיימת סכנת פיצוץ של הסוללה במידה והוחלפה בדרך לא תקינה. יש להחליף

את הסוללה בסוג התואם מחברת יצרן מומלצת.

סילוק הסוללות המושמשות יש לבצע לפי הוראות היצרן.

هناك خطر من انفجار في حالة اسبدال البطارية بطريقة غير صحيحة فعلي

اسبدال البطارية

فقط بنفس النوع أو ما يعادلها مما أوصت به الشركة المصنعة

جخلص من البطاريات المسحمة وفقا لعمليات الشركة الصانعة

## 경고!

배터리가 올바르게 교체되지 않으면 폭발의 위험이 있습니다. 기존 배터리와 동일하거나 제조사에서 권장하는 동등한 종류의 배터리로만 교체해야 합니다. 제조사의 안내에 따라 사용된 배터리를 처리하여 주십시오.

## Waarschuwing

Er is ontploffingsgevaar indien de batterij verkeerd vervangen wordt. Vervang de batterij slechts met hetzelfde of een equivalent type die door de fabrikant aanbevolen wordt. Gebruikte batterijen dienen overeenkomstig fabrieksvoorschriften afgevoerd te worden.

## Product Disposal



### Warning!

Ultimate disposal of this product should be handled according to all national laws and regulations.

## 製品の廃棄

この製品を廃棄処分する場合、国の関係する全ての法律・条例に従い処理する必要があります。

### 警告

本产品的废弃处理应根据所有国家的法律和规章进行。

### 警告

本產品的廢棄處理應根據所有國家的法律和規章進行。

## Warnung

Die Entsorgung dieses Produkts sollte gemäß allen Bestimmungen und Gesetzen des Landes erfolgen.

### ¡Advertencia!

Al deshacerse por completo de este producto debe seguir todas las leyes y reglamentos nacionales.

### Attention

La mise au rebut ou le recyclage de ce produit sont généralement soumis à des lois et/ou directives de respect de l'environnement. Renseignez-vous auprès de l'organisme compétent.

סילוק המוצר

אזהרה!

סילוק סופי של מוצר זה חייב להיות בהתאם להנחיות וחוקי המדינה.

عند التخلص النهائي من هذا المنتج ينبغي التعامل معه وفقا لجميع القوانين واللوائح الوطنية

### 경고!

이 제품은 해당 국가의 관련 법규 및 규정에 따라 폐기되어야 합니다.

## Waarschuwing

De uiteindelijke verwijdering van dit product dient te geschieden in overeenstemming met alle nationale wetten en reglementen.

## Contacting Supermicro

### Headquarters

Address: Super Micro Computer, Inc.  
980 Rock Ave.  
San Jose, CA 95131 U.S.A.

Tel: +1 (408) 503-8000

Fax: +1 (408) 503-8008

Email: [marketing@supermicro.com](mailto:marketing@supermicro.com) (General Information)  
[support@supermicro.com](mailto:support@supermicro.com) (Technical Support)

Website: [www.supermicro.com](http://www.supermicro.com)

### Europe

Address: Super Micro Computer B.V.  
Het Sterrenbeeld 28, 5215 ML  
's-Hertogenbosch, The Netherlands

Tel: +31 (0) 73-6400390

Fax: +31 (0) 73-6416525

Email: [sales@supermicro.nl](mailto:sales@supermicro.nl) (General Information)  
[support@supermicro.nl](mailto:support@supermicro.nl) (Technical Support)  
[rma@supermicro.nl](mailto:rma@supermicro.nl) (Customer Support)

Website: [www.supermicro.nl](http://www.supermicro.nl)

### Asia-Pacific

Address: Super Micro Computer, Inc.  
3F, No. 150, Jian 1st Rd.  
Zhonghe Dist., New Taipei City 235  
Taiwan (R.O.C)

Tel: +886-(2) 8226-3990

Fax: +886-(2) 8226-3992

Email: [support@supermicro.com.tw](mailto:support@supermicro.com.tw)

Website: [www.supermicro.com.tw](http://www.supermicro.com.tw)

## Where to Find More Information

For your system to work properly, please follow the links below to download all necessary drivers/utilities and the user's manual for your motherboard.

Supermicro product manuals: <http://www.supermicro.com/support/manuals/>

Product Drivers and utilities: <ftp://ftp.supermicro.com/>

If you have any questions, please contact our support team at [support@supermicro.com](mailto:support@supermicro.com).

# Table of Contents

## Preface

|                                       |      |
|---------------------------------------|------|
| Manual Organization .....             | iii  |
| Checklist .....                       | iv   |
| Conventions Used in the Manual .....  | iv   |
| Standardized Warning Statements ..... | v    |
| Battery Handling.....                 | v    |
| Product Disposal.....                 | vi   |
| Contacting Supermicro.....            | viii |
| Where to Find More Information.....   | ix   |

## Chapter 1 Introduction

|  |     |
|--|-----|
| 1-1 Overview .....                                 | 1-1 |
| About this Motherboard .....                       | 1-1 |
| 1-2 Chipset Overview .....                         | 1-1 |
| Intel X299 Chipset Features.....                   | 1-1 |
| 1-3 Motherboard Features .....                     | 1-2 |
| 1-4 Special Features .....                         | 1-4 |
| Recovery from AC Power Loss .....                  | 1-4 |
| 1-5 PC Health Monitoring.....                      | 1-4 |
| Fan Status Monitor with Firmware Control .....     | 1-4 |
| Environmental Temperature Control .....            | 1-4 |
| System Resource Alert .....                        | 1-5 |
| 1-6 ACPI Features .....                            | 1-5 |
| Slow Blinking LED for Suspend-State Indicator..... | 1-5 |
| 1-7 Power Supply .....                             | 1-6 |
| 1-8 Super I/O .....                                | 1-6 |

## Chapter 2 Installation

|  |     |
|--|-----|
| 2-1 Installation Components and Tools Needed ..... | 2-1 |
| 2-2 Static-Sensitive Devices.....                  | 2-2 |
| Precautions .....                                  | 2-2 |
| Unpacking.....                                     | 2-2 |
| 2-3 Processor and Heatsink Installation.....       | 2-3 |
| Installing the Processor .....                     | 2-3 |
| Installing a CPU Heatsink.....                     | 2-7 |
| Removing a Heatsink .....                          | 2-8 |
| 2-4 Installing DDR4 Memory .....                   | 2-9 |
| DIMM Installation .....                            | 2-9 |
| Removing Memory Modules.....                       | 2-9 |

---

|     |   |      |
|-----|---|------|
|     | Memory Support.....                             | 2-10 |
|     | Memory Population Guidelines.....               | 2-11 |
| 2-5 | Motherboard Installation.....                   | 2-12 |
|     | Tools Needed.....                               | 2-12 |
|     | Location of Mounting Holes.....                 | 2-12 |
|     | Installing the Motherboard.....                 | 2-13 |
| 2-6 | M.2 Installation (optional).....                | 2-14 |
| 2-7 | Connectors/IO Ports.....                        | 2-15 |
|     | I/O Back Panel.....                             | 2-15 |
|     | C9X299-PGF.....                                 | 2-15 |
|     | Universal Serial Bus (USB).....                 | 2-16 |
|     | C9X299-PGF.....                                 | 2-16 |
|     | Ethernet Port.....                              | 2-17 |
|     | C9X299-PGF.....                                 | 2-17 |
|     | ATX PS/2 Keyboard/Mouse Port.....               | 2-18 |
|     | VGA Port.....                                   | 2-18 |
|     | HD AUDIO Ports.....                             | 2-18 |
|     | C9X299-PGF.....                                 | 2-18 |
|     | Front Control Panel.....                        | 2-19 |
|     | Front Control Panel Pin Definitions.....        | 2-20 |
|     | Power LED.....                                  | 2-20 |
|     | HDD LED.....                                    | 2-20 |
|     | NIC1/NIC2 Activity LED.....                     | 2-20 |
|     | Overheat (OH)/Fan Fail.....                     | 2-21 |
|     | Power Fail LED.....                             | 2-21 |
|     | Power Button.....                               | 2-22 |
|     | Reset Button.....                               | 2-22 |
| 2-8 | Connecting Cables.....                          | 2-23 |
|     | ATX Main PWR and CPU PWR Connectors.....        | 2-23 |
|     | Fan Headers.....                                | 2-24 |
|     | Chassis Intrusion.....                          | 2-24 |
|     | Internal Buzzer/Speaker.....                    | 2-25 |
|     | Speaker.....                                    | 2-25 |
|     | Serial Port.....                                | 2-26 |
|     | 4-pin External BMC I <sup>2</sup> C Header..... | 2-26 |
|     | DOM PWR Connector.....                          | 2-27 |
|     | Intel RAID Key Header.....                      | 2-27 |
|     | U.2 SSD Connectors.....                         | 2-28 |

---

|      |   |      |
|------|---|------|
|      | M.2 Connectors.....                       | 2-28 |
|      | Front Panel Audio Header.....             | 2-29 |
|      | TPM Header/Port 80 .....                  | 2-29 |
|      | Standby Power Header .....                | 2-30 |
|      | Power SMB (I <sup>2</sup> C) Header ..... | 2-30 |
| 2-9  | Jumper Settings .....                     | 2-31 |
|      | Explanation of Jumpers .....              | 2-31 |
|      | Clear CMOS & JBT1 .....                   | 2-32 |
|      | Watch Dog Timer Enable/Disable .....      | 2-32 |
|      | Manufacturing Mode .....                  | 2-33 |
|      | Audio Enable .....                        | 2-33 |
|      | Power Button.....                         | 2-34 |
|      | Reset Button .....                        | 2-34 |
|      | VGA Enable/Disable.....                   | 2-35 |
| 2-10 | Onboard Indicators .....                  | 2-36 |
|      | LAN LEDs.....                             | 2-36 |
|      | Onboard Power LED.....                    | 2-36 |
|      | Status Display .....                      | 2-37 |
|      | M.2 Activity LEDs.....                    | 2-37 |
| 2-11 | Hard Drive Connections.....               | 2-38 |
|      | SATA Connections (I-SATA0~I-SATA5) .....  | 2-38 |
|      | U.2 SSD Connectors .....                  | 2-38 |

### Chapter 3 Troubleshooting

|     |   |     |
|-----|---|-----|
| 3-1 | Troubleshooting Procedures.....                         | 3-1 |
|     | Before Power On.....                                    | 3-1 |
|     | No Power.....   | 3-1 |
|     | No Video .....  | 3-2 |
|     | Memory Errors .....                                     | 3-2 |
|     | When the System is Losing the Setup Configuration ..... | 3-2 |
| 3-2 | Technical Support Procedures.....                       | 3-3 |
| 3-3 | Frequently Asked Questions .....                        | 3-4 |
| 3-4 | Battery Removal and Installation .....                  | 3-5 |
|     | Battery Removal .....                                   | 3-5 |
|     | Proper Battery Disposal .....                           | 3-5 |
| 3-5 | Returning Motherboard for Service.....                  | 3-6 |
|     | Battery Installation .....                              | 3-6 |

### Chapter 4 BIOS

|     |                    |     |
|-----|--------------------|-----|
| 4-1 | Introduction ..... | 4-1 |
| 4-2 | EZ Mode.....       | 4-3 |

---

|      |                    |      |
|------|--------------------|------|
| 4-3  | Main.....          | 4-4  |
| 4-4  | Overclocking ..... | 4-7  |
| 4-5  | CPU .....          | 4-23 |
| 4-6  | Memory .....       | 4-28 |
| 4-7  | Advanced.....      | 4-31 |
| 4-8  | IPMI.....          | 4-51 |
| 4-9  | Boot.....          | 4-54 |
| 4-10 | BIOS Update.....   | 4-56 |

**Appendix A BIOS Error Beep Codes**

|     |                             |     |
|-----|-----------------------------|-----|
| A-1 | BIOS Error Beep Codes ..... | A-1 |
|-----|-----------------------------|-----|

**Appendix B Software Installation Instructions**

|     |                                  |     |
|-----|----------------------------------|-----|
| B-1 | Installing Drivers .....         | B-1 |
| B-2 | Configuring SuperDoctor® 5 ..... | B-2 |

**Appendix C UEFI BIOS Recovery Instructions**

|     |  |     |
|-----|--|-----|
| C-1 | An Overview to the UEFI BIOS .....                             | C-1 |
| C-2 | How to Recover the UEFI BIOS Image (the Main BIOS Block) ..... | C-1 |
| C-3 | To Recover the Main BIOS Block Using a USB-Attached Device.... | C-2 |

## Notes

# **Chapter 1**

## **Introduction**

### **1-1 Overview**

#### **About this Motherboard**

The C9X299-PGF/-RPGF motherboard supports a single Intel® Core™ X-series processor in an LGA2066 R4 socket. With the Intel X299 chipset built in, the C9X299-PGF/-RPGF motherboard offers substantial system performance and storage capability for overclocking platforms in a sleek package. Please refer to our website (<http://www.supermicro.com/products/>) for processor and memory support updates.

### **1-2 Chipset Overview**

#### **Intel X299 Chipset Features**

- Direct Media Interface (up to 10 Gb/s transfer, Full Duplex)
- Intel® Matrix Storage Technology and Intel Rapid Storage Technology
- Dual NAND Interface
- Intel I/O Virtualization (VT-d) Support
- Intel Trusted Execution Technology Support
- PCI Express 3.0 Interface (up to 8 GT/s)
- SATA Controller (up to 6Gb/sec)
- Advanced Host Controller Interface (AHCI)

## 1-3 Motherboard Features

|                                    |  |  |  |
|------------------------------------|--|--|--|
| <b>CPU</b>                         | Intel® Core™ X-series processor in an LGA2066 R4 type socket.                                |  |  |
| <b>Memory</b>                      | Supports up to 128GB of unbuffered, non-ECC, DDR4 memory with speeds of up to 3000+MHz (OC). |  |  |
|                                    | Dual-channel memory  |  |  |
|                                    | <b>DIMM sizes</b>  |  |  |
|                                    | UDIMM  | Up to 128GB at 1.2V                        |  |
| <b>Chipset</b>                     | Intel X299 chipset   |  |  |
| <b>Expansion Slots</b>             | Four (4) CPU PCI-E 3.0 x16 slot  |  |  |
|                                    | One (1) PCH PCI-E 3.0 x1 slot  |  |  |
|                                    | Two (2) M.2 slots  |  |  |
| <b>Network Connections</b>         | Intel I210-AT Network Controller   |  |  |
|                                    | Aquantia AQC 108   |  |  |
|                                    | Two (2) RJ-45 ports with Link and Activity LEDs on the I/O back panel                        |  |  |
| <b>I/O Devices</b>                 | <b>Hard Drive Connections</b>  |  |  |
|                                    | SATA 3.0 (6Gb/s)   | Six (6) I-SATA 0~5 via Intel X299          |  |
|                                    |  | RAID 0, 1, 5, 10                           |  |
|                                    | U.2 Connectors   | Two (2) U.2 Connectors for 2.5" SSD Drives |  |
|                                    | <b>USB Devices</b>   |  |  |
|                                    | One (1) USB 3.1 Type-C port on the I/O back panel  |  |  |
|                                    | Three (3) USB 3.1 Type-A ports on the I/O back panel   |  |  |
|                                    | Two (2) USB 3.0 ports on the I/O back panel  |  |  |
|                                    | One (1) front accessible USB 3.0 headers   |  |  |
|                                    | Two (2) front accessible USB 2.0 headers   |  |  |
|                                    | <b>Keyboard/Mouse</b>  |  |  |
|                                    | One PS/2 Keyboard/Mouse port on the I/O back panel   |  |  |
|                                    | <b>Other I/O Ports</b>   |  |  |
| One (1) VGA Port                   |  |  |  |
| One (1) Serial Port header (JCOM1) |  |  |  |
| <b>Graphics</b>                    |  |  |  |
| Aspeed AST2500 Graphics Controller |  |  |  |

|                            |   |
|----------------------------|---|
|                            | <p style="text-align: center;"><b>Audio</b></p> <p>One (1) High Definition Audio 7.1 channel connector supported by Realtek ALC1150 on the back panel. (-PGF)</p> <p>One (1) Front Panel Audio Header</p> <p style="text-align: center;"><b>Super I/O</b></p> <p>Nuvoton NCT6792D-B</p>   |
| <b>BIOS</b>                | <p>256Mb AMI BIOS® SPI Flash BIOS</p> <p>DMI 2.8, PCI 3.0, ACPI 3.0, BIOS rescue hot-key, SPI dual/quad speed support, Overclock support</p>  |
| <b>Power Configuration</b> | <p>ACPI Power Management (S3/S4/S5)</p> <p>Power Button Override Mechanism</p> <p>Power-on mode for AC power recovery</p>   |
| <b>Health Monitoring</b>   | <p style="text-align: center;"><b>CPU Monitoring</b></p> <p>Onboard monitors: +2.5V, +5V, + 12V, +1V Stby, +3.3V Stby, +5V Stby, Memory, CPU, PCH Temperature, CPU Temperature, and System Temperature</p> <p>6-phase CPU switching voltage regulator</p> <p>CPU/System overheat LED and control</p> <p>CPU Thermal Trip support</p> <p style="text-align: center;"><b>Fan Control</b></p> <p>Five (5) proprietary 4-pin fan headers</p> <p>Low noise fan speed control</p> |
| <b>System Management</b>   | <p>PECI (Platform Environment Configuration Interface) 2.0 support</p> <p>System resource alert via SuperDoctor® 5</p> <p>SuperDoctor® 5, NMI</p> <p>Chassis Intrusion header and detection</p>   |
| <b>CD Utilities</b>        | <p>BIOS flash upgrade utility</p> <p>Drivers and software for Intel X299 chipset utilities</p>  |
| <b>LED Indicators</b>      | <p>CPU/System Overheat, Power/suspend state, Fan Failure, HDD activity, LAN activity</p>  |
| <b>Dimensions</b>          | <p>ATX form factor (12.0" x 9.6") (304.8 mm x 243.84 mm)</p>  |

## 1-4 Special Features

### Recovery from AC Power Loss

Basic I/O System (BIOS) provides a setting for you to determine how the system will respond when AC power is lost and then restored to the system. You can choose for the system to remain powered off, (in which case you must press the power switch to turn it back on), or for it to automatically return to a power-on state. See the Advanced BIOS Setup section to change this setting. The default setting is **Last State**.

## 1-5 PC Health Monitoring

This section describes the PC health monitoring features of the board. All have an onboard System Hardware Monitoring chip that supports PC health monitoring. An onboard voltage monitor will scan these onboard voltages continuously: +2.5V, +5V, +12V, +1V Stby, +3.3V Stby, VBAT, Memory, CPU, PCH Temperature, CPU Temperature, and System Temperature. Once a voltage becomes unstable, a warning is given, or an error message is sent to the screen. The user can adjust the voltage thresholds to define the sensitivity of the voltage monitor.

### Fan Status Monitor with Firmware Control

PC health monitoring in the BIOS can check the RPM status of the cooling fans. The onboard CPU and chassis fans are controlled by Thermal Management via SIO.

### Environmental Temperature Control

The thermal control sensor monitors the CPU temperature in real time and will turn on the thermal control fan whenever the CPU temperature exceeds a user-defined threshold. The overheat circuitry runs independently from the CPU. Once the thermal sensor detects that the CPU temperature is too high, it will automatically turn on the thermal fans to prevent the CPU from overheating. The onboard chassis thermal circuitry can monitor the overall system temperature and alert the user when the chassis temperature is too high.



**Note:** To avoid possible system overheating, please be sure to provide adequate airflow to your system.

## **System Resource Alert**

This feature is available when the system is used with SuperDoctor 5 in the Windows and Linux operating systems. SuperDoctor is used to notify the user of certain system events. For example, you can also configure SuperDoctor to provide you with warnings when the system temperature, CPU temperatures, voltages and fan speeds go beyond predefined thresholds.

## **1-6 ACPI Features**

ACPI stands for Advanced Configuration and Power Interface. The ACPI specification defines a flexible and abstract hardware interface that provides a standard way to integrate power management features throughout a PC system, including its hardware, operating system and application software. This enables the system to automatically turn on and off peripherals such as CD-ROMs, network cards, hard disk drives and printers.

In addition to enabling operating system-directed power management, ACPI also provides a generic system event mechanism for Plug and Play, and an operating system-independent interface for configuration control. ACPI leverages the Plug and Play BIOS data structures, while providing a processor architecture-independent implementation that is compatible with Windows 7, Windows 8, Windows 10, and Windows 2008 Operating Systems.

### **Slow Blinking LED for Suspend-State Indicator**

When the CPU goes into a suspend state, the chassis power LED will start to blink to indicate that the CPU is in suspend mode. When the user presses any key, the CPU will wake up, and the LED will automatically stop blinking and remain on.

## 1-7 Power Supply

As with all computer products, a stable power source is necessary for proper and reliable operation. It is even more important for processors that have high CPU clock rates.

This motherboard accommodates 24-pin ATX power supplies. Although most power supplies generally meet the specifications required by the CPU, some are inadequate. In addition, the 12V 8-pin power connector located at JPW2 is also required to ensure adequate power supply to the system. Additionally, there is a 12V 4-pin connector located at JPW3. Your power supply must supply 1.5A for the Ethernet ports.

**! Attention!** To prevent damage to the power supply or motherboard, please use a power supply that contains a 24-pin and a 8-pin power connectors. Be sure to connect these connectors to the 24-pin (JPW1) and the 8-pin (JPW2) power connectors on the motherboard.

It is strongly recommended that you use a high quality power supply that meets ATX power supply Specification 2.02 or above. It must also be SSI compliant. (For more information, please refer to the website at <http://www.ssiforum.org/>). Additionally, in areas where noisy power transmission is present, you may choose to install a line filter to shield the computer from noise. It is recommended that you also install a power surge protector to help avoid problems caused by power surges.

## 1-8 Super I/O

The Super I/O supports two high-speed, 16550 compatible serial communication ports (UARTs). Each UART includes a 16-byte send/receive FIFO, a programmable baud rate generator, complete modem control capability and a processor interrupt system. Both UARTs provide legacy speed with baud rate of up to 115.2 Kbps as well as an advanced speed with baud rates of 250 K, 500 K, or 1 Mb/s, which support higher speed modems.

The Super I/O provides functions that comply with ACPI (Advanced Configuration and Power Interface), which includes support of legacy and ACPI power management through an SMI or SCI function pin. It also features auto power management to reduce power consumption.

## C9X299-PGF Motherboard Image

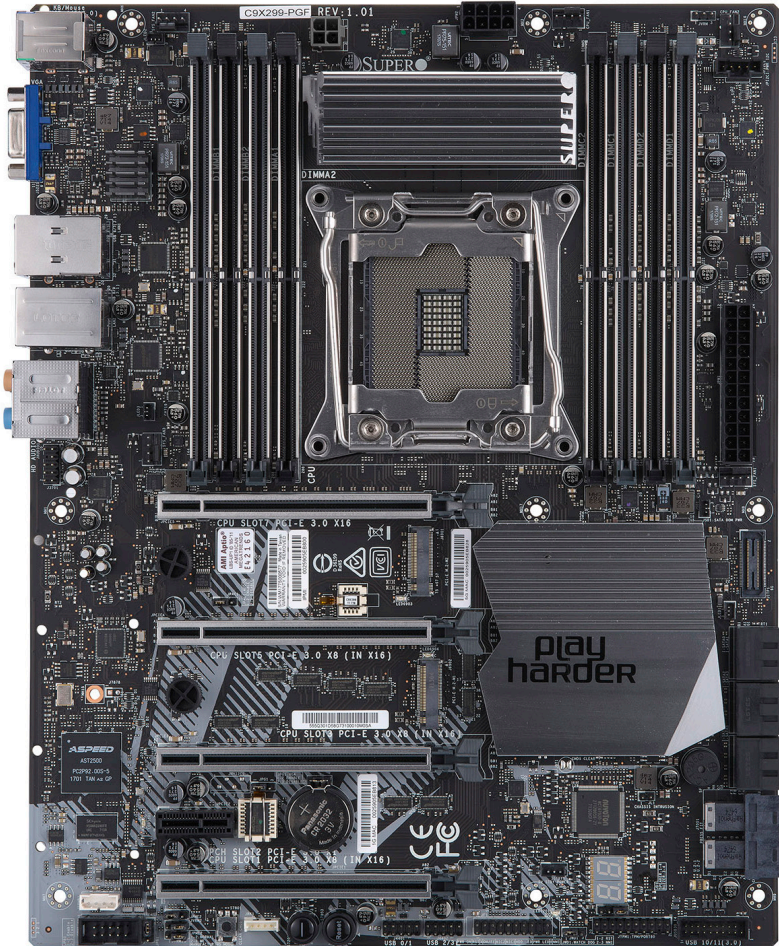

**Note:** All graphics shown in this manual were based upon the latest PCB Revision available at the time of publishing of the manual. The motherboard you've received may or may not look exactly the same as the graphics shown in this manual.

C9X299-RPGF Motherboard Image

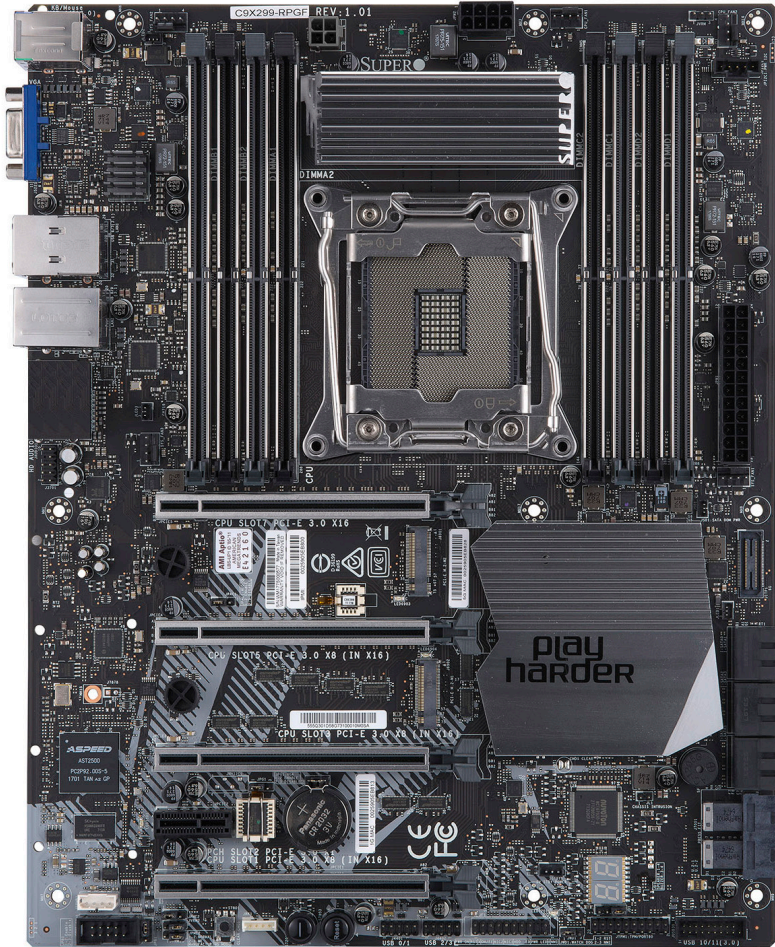

## C9X299-PGF Motherboard Layout

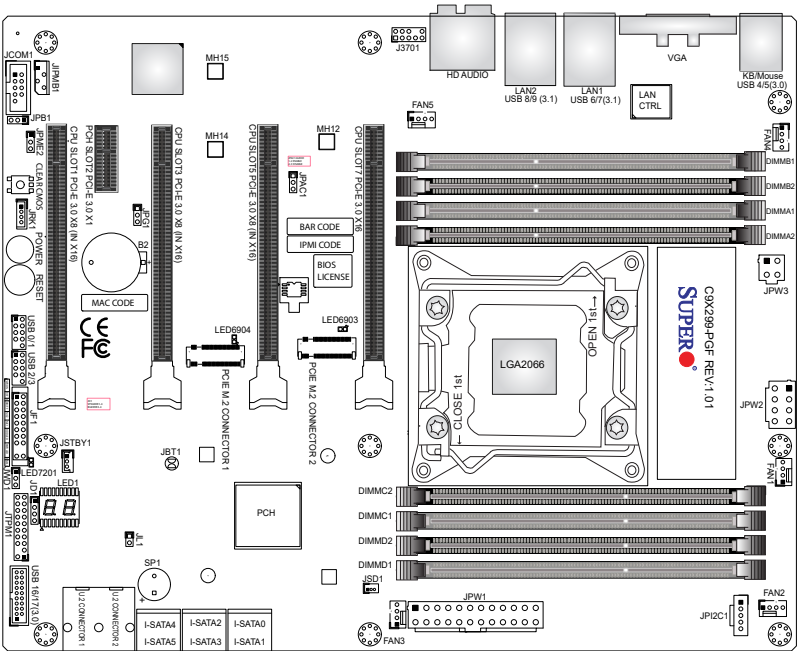

**Note:** All motherboard layout diagrams in this manual use the C9X299-PGF layout. Depending on the specific model of motherboard you've received, it may or may not have exactly the same as the layout design shown in this manual.



### Important Notes to the User

- See Chapter 2 for detailed information on jumpers, I/O ports and JF1 front panel connections.
- "■" indicates the location of "Pin 1".
- Jumpers not indicated are for testing only.
- When LED1 (Onboard Power LED Indicator) is on, system power is on. Unplug the power cable before installing or removing any components.



**Note:** Block diagrams differ based on the amount of PCI Express Lanes the installed processor has.

### C9X299-PGF 16 Lanes Block Diagram

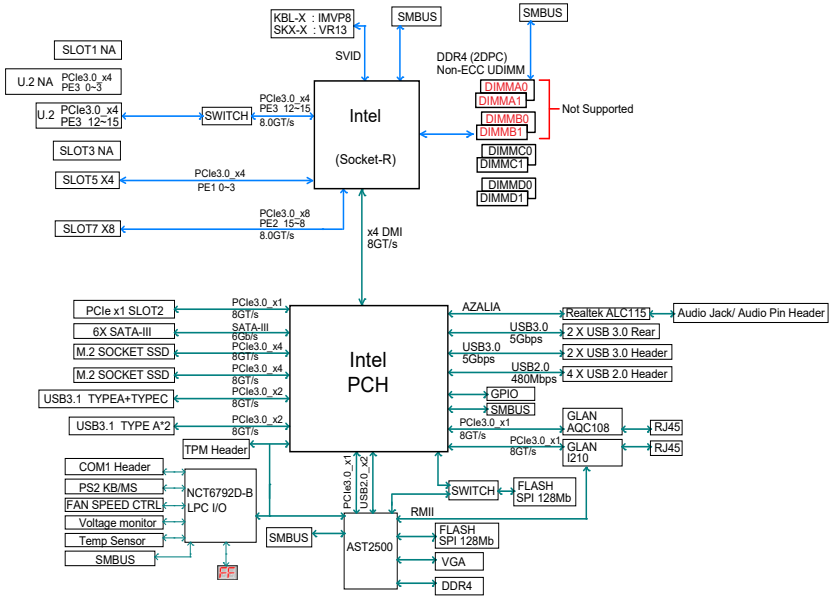

### C9X299-PGF 28 Lanes Block Diagram

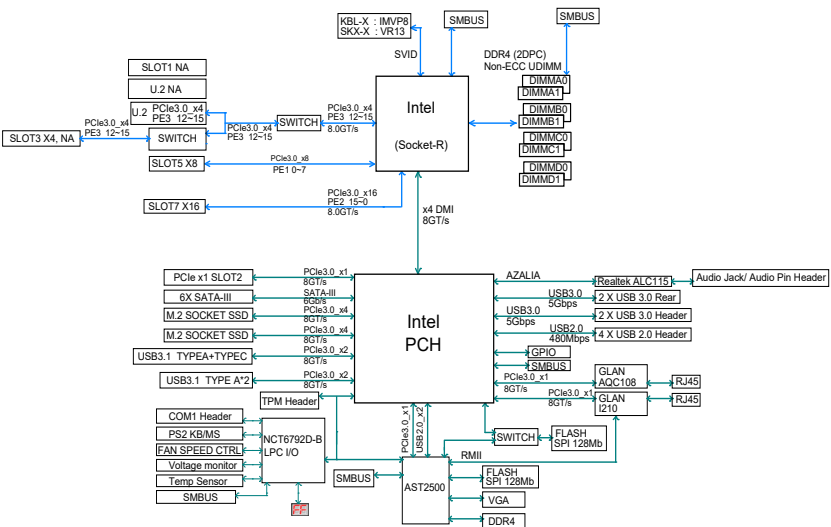

**C9X299-PGF 44 Lanes Block Diagram**

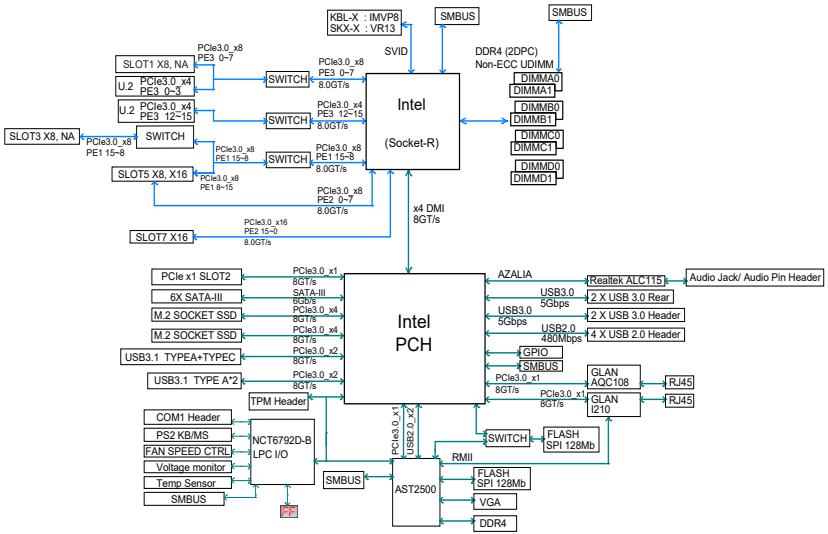

**C9X299-PG Quick Reference**

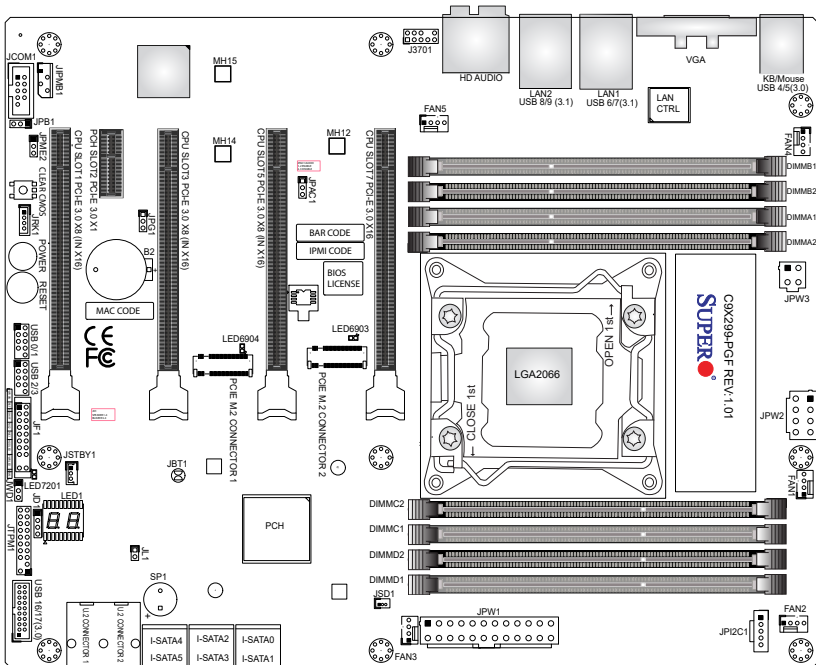

| <b>Jumper</b> | <b>Description</b>          | <b>Default</b>                            |
|---------------|-----------------------------|---|
| CLEAR CMOS    | Clear CMOS Switch           | Push Button Switch                        |
| JBT1          | Clear CMOS                  | Short pads to clear CMOS                  |
| JPAC1         | Audio Enable                | Pins 1-2 (Enabled)                        |
| JPB1          | IPMI Function               | Pins 1-2 (Enabled)<br>Pins 2-3 (Disabled) |
| JPG1          | VGA Enable/Disable          | Pins 1-2 (Enabled)                        |
| JPME2         | Intel® Manufacturing Mode   | Pins 1-2 (Normal)                         |
| JWD1          | Watch Dog Function Enable   | Pins 1-2 (RST)                            |
| POWER BUTTON  | Internal Power Button       | Push Button Switch                        |
| RESET BUTTON  | Onboard System Reset Button | Push Button Switch                        |

| Connector                    | Description  |
|------------------------------|--|
| B2                           | Onboard Battery  |
| FAN1~5                       | System/CPU Fan Headers<br>(FAN1/FAN2: CPU Fans)  |
| HD AUDIO                     | High Definition Audio Ports (back panel)<br>(C9X299-PGF only)  |
| I-SATA0~5                    | Intel X299 SATA 3.0 Ports (6Gb/sec)  |
| J3701                        | Front Panel Audio Header   |
| JCOM1                        | COM Header   |
| JD1                          | Speaker/buzzer<br>(Pins 1~4: External Speaker, Pins 3~4:<br>Buzzer)                                      |
| JF1                          | Front Control Panel Header   |
| JIPMB1                       | 4-pin External I <sup>2</sup> C Header (for an IPMI<br>card)   |
| JL1                          | Chassis Intrusion Header   |
| JPI2C1                       | Power Supply SMBus I <sup>2</sup> C Header   |
| JPW1                         | 24-pin ATX Main Power Connector (Re-<br>quired)  |
| JPW2                         | +12V 8-pin CPU power Connector (Re-<br>quired)   |
| JPW3                         | +12V 4-pin CPU Power Connector   |
| JRK1                         | Intel RAID Key Header  |
| JSD1                         | SATA DOM (Disk On Module) Power Con-<br>nector   |
| JSTBY1                       | Standby Power Header   |
| JTPM1                        | Trusted Platform Module (TPM) Header   |
| LAN1/LAN2                    | LAN1: 5Gb LAN port<br>LAN2: 1Gb LAN Port (IPMI LAN)  |
| PCI-E M.2 CONNECTOR 1,<br>2* | PCI-E M.2 connectors small form factor<br>devices and other portable devices for<br>high speed NVMe SSDs |
| SP1                          | Internal Buzzer/Speaker  |
| U.2 CONNECTOR 1, 2*          | U.2 connectors for 2.5" SSD Drives   |
| USB0/1, 2/3                  | Front Access USB 2.0 Headers   |
| USB4/5                       | Back panel USB 3.0 ports   |

|             |  |
|-------------|--|
| USB6/7, 8/9 | Back panel USB 3.1 Ports<br>(USB8: Type A, USB9: Type C) |
| USB16/17    | Front Access USB 3.0 Header                              |
| VGA         | Back panel VGA port                                      |

| <b>LED</b> | <b>Description</b>             | <b>Color/State</b> | <b>Status</b>                           |
|------------|--------------------------------|--------------------|---|
| LED1       | Status Code LED                | Digital Read-out   | See the link below for code definitions |
| LED7201    | Onboard Standby PWR LED        | Solid Green        | Power On                                |
| LED6903    | M.2 connector 2 SSD Active LED | Solid Green        | M.2 device active                       |
| LED6904    | M.2 connector 1 SSD Active LED | Solid Green        | M.2 device active                       |

\*Download the AMI status codes at [https://ami.com/ami\\_downloads/Aptio\\_V\\_Status\\_Codes.pdf](https://ami.com/ami_downloads/Aptio_V_Status_Codes.pdf)



**Note:** Refer to the table below to determine how each CPU affects PCIe Slot support.

| <b>PCIe Slot Configuration Support</b> |              |              |              |              |               |               |
|--|--------------|--------------|--------------|--------------|---------------|---------------|
| <b>Intel Core™ CPU</b>                 | <b>SLOT1</b> | <b>SLOT3</b> | <b>SLOT5</b> | <b>SLOT7</b> | <b>U.2_1</b>  | <b>U.2_2</b>  |
| i7 7740X<br>i5 7640X                   | N/A          | N/A          | x4           | x8           | N/A           | x4            |
| i7 7820X<br>i7 7800X                   | N/A          | x4<br>(def.) | x8           | x16          | N/A           | N/A<br>(def.) |
|  |              | N/A          |              |              |               | x4            |
| i9 7980X<br>i9 7900X                   | x8<br>(def.) | x8<br>(def.) | x8<br>(def.) | x16          | N/A<br>(def.) | x4            |
|  | N/A          | N/A          | x16          |              | x4            |               |

*\*Note: "def." in the above table denotes the default setting.*

## Chapter 2

### Installation

#### 2-1 Installation Components and Tools Needed

Screws

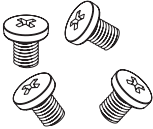

Phillips-Head Screwdriver

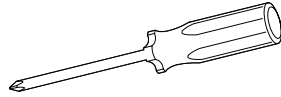

Intel LGA 2066 Processor

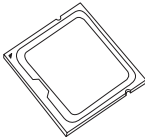

DDR4 DIMMs

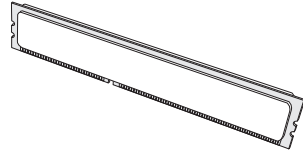

PC Chassis



Heatsink with Fan



Power Supply

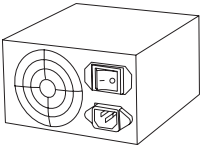

Video Card (Optional)

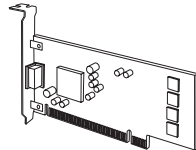

SATA/USB Optical Drive (Optional)

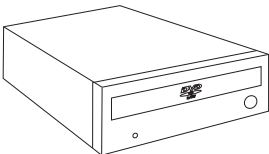

SATA Hard Disk Drive

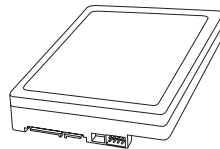

## 2-2 Static-Sensitive Devices

Electrostatic-Discharge (ESD) can damage electronic components. To avoid damaging your system board, it is important to handle it very carefully. The following measures are generally sufficient to protect your equipment from ESD.

### Precautions

- Use a grounded wrist strap designed to prevent static discharge.
- Touch a grounded metal object before removing the board from the antistatic bag.
- Handle the board by its edges only; do not touch its components, peripheral chips, memory modules or gold contacts.
- When handling chips or modules, avoid touching their pins.
- Put the motherboard and peripherals back into their antistatic bags when not in use.
- For grounding purposes, make sure your computer chassis provides excellent conductivity between the power supply, the case, the mounting fasteners and the motherboard.
- Use only the correct type of onboard CMOS battery. Do not install the onboard battery upside down to avoid possible explosion.

### Unpacking

The motherboard is shipped in antistatic packaging to avoid static damage. When unpacking the board, make sure that the person handling it is static protected.

## 2-3 Processor and Heatsink Installation



**Attention!** When handling the processor package, avoid placing direct pressure on the label area of the fan.



### Important:

- Always connect the power cord last, and always remove it before adding, removing or changing any hardware components. Make sure that you install the processor into the CPU socket before you install the CPU heatsink.
- If you buy a CPU separately, make sure that you use an Intel-certified multi-directional heatsink only.
- Make sure to install the system board into the chassis before you install the CPU heatsink.
- When receiving a server board without a processor pre-installed, make sure that the plastic CPU socket cap is in place and none of the socket pins are bent; otherwise, contact your retailer immediately.
- Refer to the Supermicro website for updates on CPU support.

### Installing the Processor

1. Remove the WARNING plastic cap from the socket.

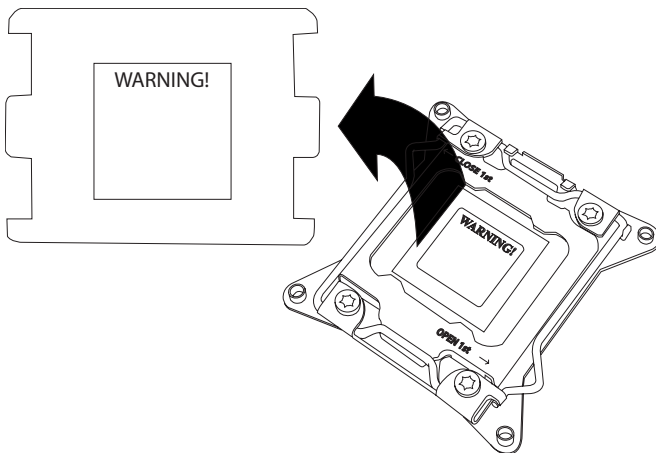

2. There are two load levers on the LGA2066 socket. To open the socket cover, press and release the load lever labeled "Open 1st".

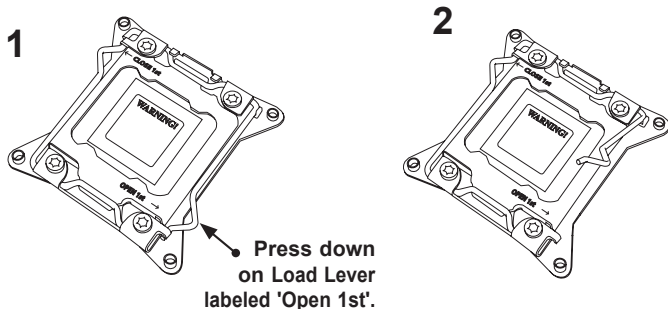

3. Press the second load lever labeled "Close 1st" to release the load plate that covers the CPU socket from its locking position.

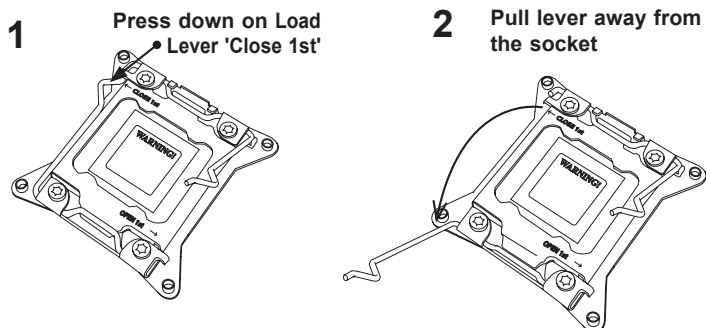

4. With the "Close 1st" lever fully retracted, gently push down on the "Open 1st" lever to open the load plate. Lift the load plate to open it completely.

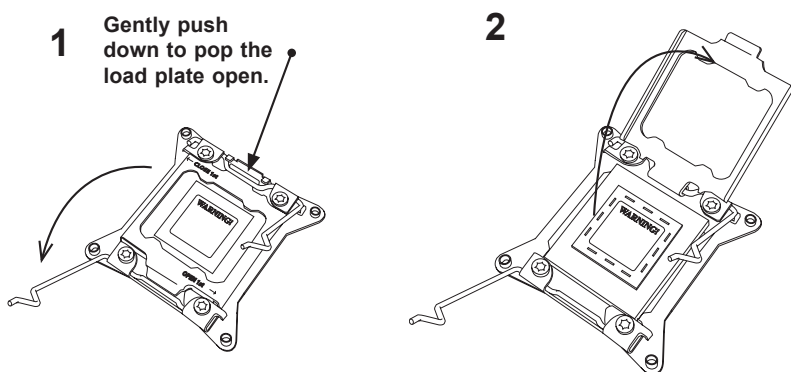

5. Use your thumb and index finger to hold the CPU on its edges. Align the CPU keys, which are semi-circle cutouts, against the socket keys.

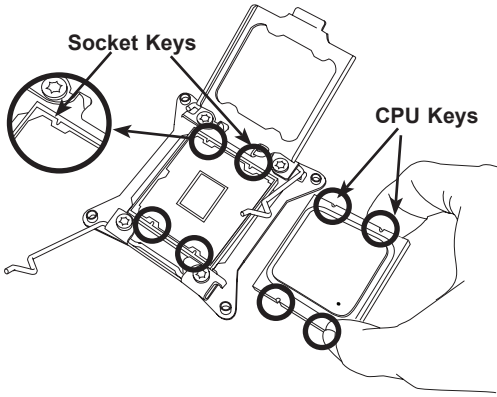

6. Once they are aligned, carefully lower the CPU straight down into the socket. To avoid damaging the CPU or socket, do not drop the CPU onto the socket, move it horizontally or vertically, or rub it against the socket pins.
7. With the CPU inside the socket, inspect the four corners of the CPU to make sure that it is properly installed.

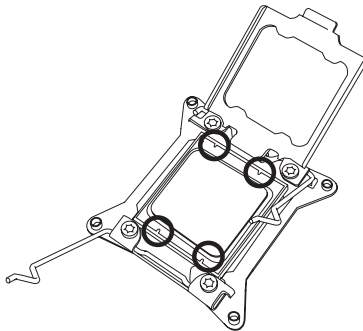

8. Close the load plate with the CPU inside the socket. Lock the "Close 1st" lever first, then lock the "Open 1st" lever second. Gently push the load levers down to the lever locks.

- 1 Gently close the load plate.

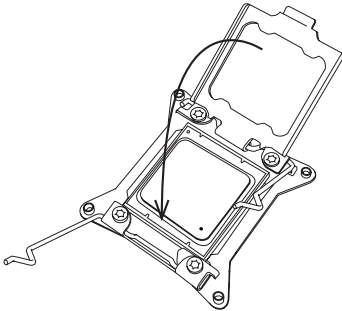

- 2 Push down and lock 'Close 1st' lever.

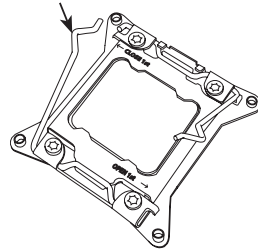

- 3 Lever Lock Push down and lock 'Open 1st' lever

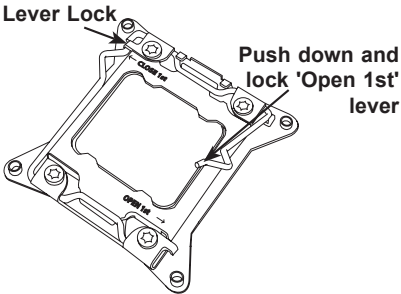

- 4 Lever Lock

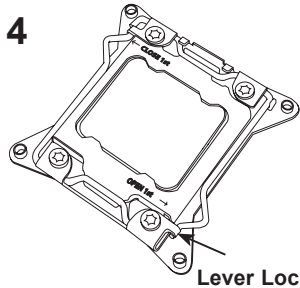

## Installing a CPU Heatsink

1. Apply the proper amount of thermal grease to the heatsink.
2. Place the heatsink on top of the CPU so that the two mounting holes on the heatsink are aligned with those on the retention mechanism. Tighten the screws in the following order:

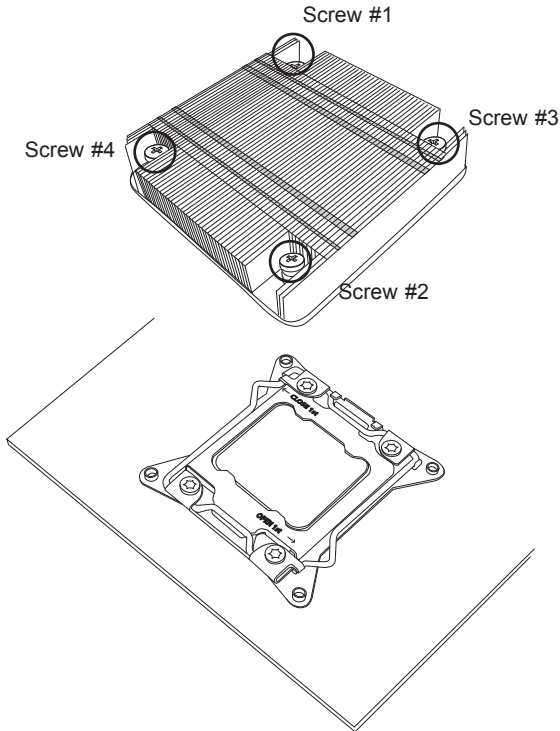

**Note:** Graphic drawings included in this manual are for reference only. They might look different from the components installed in your system.

## Removing a Heatsink

**Warning:** We do not recommend that the CPU or the heatsink be removed. However, if you do need to remove the heatsink, please follow the instructions below to uninstall the heatsink to avoid damaging the CPU or other components.

1. Unplug the power cord from the power supply.
2. Loosen the screws in the order below.
3. Gently wiggle the heatsink to loosen it. Do not use excessive force when wiggling the heatsink.

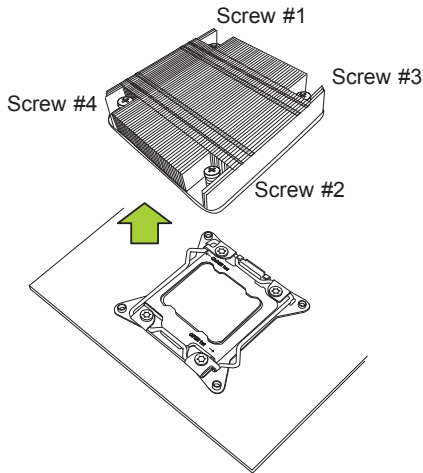

4. Once the heatsink is loosened, remove it from the motherboard.

## 2-4 Installing DDR4 Memory



**Note:** Check the Supermicro website for recommended memory modules.



**Attention!** Exercise extreme care when installing or removing DIMM modules to prevent any possible damage.

### DIMM Installation

1. Insert the desired number of DIMMs into the memory slots, starting with DIMMA1, DIMMB1, DIMMC1, DIMMD1, then DIMMA2, DIMMB2, DIMMC2, DIMMD2. For the system to work properly, please use memory modules of the same type and speed.
2. Align the DIMM module key with the receptive point on the single-latch DIMM slot.
3. Push the release tab outward to unlock the slot.
4. Align the notch on the end of the module against the receptive point on the end of the slot.
5. Press both ends of the module straight down into the slot until the module snaps into place.
6. Push the release tab to the lock position to secure the module into the slot.

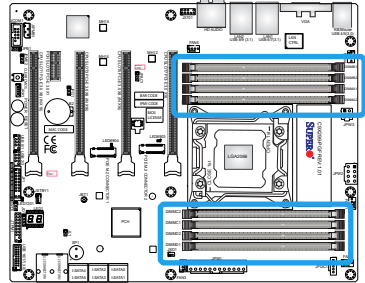

Module Key

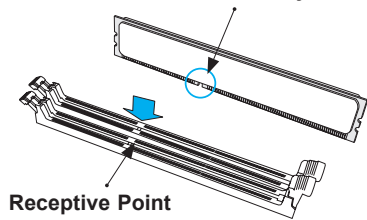

Receptive Point

Notch

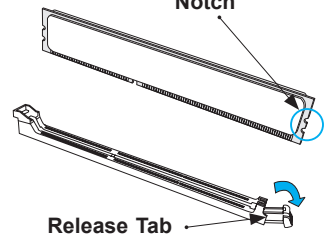

Release Tab

Press both notches straight down into the memory slot.

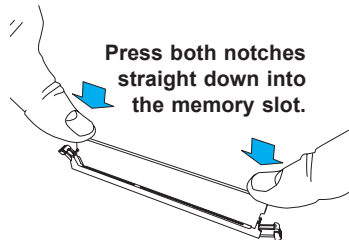

### Removing Memory Modules

Reverse the steps above to remove the DIMM modules from the motherboard.

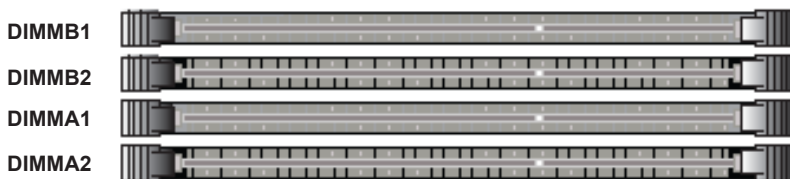

↓ Towards the CPU

↑ Towards the CPU

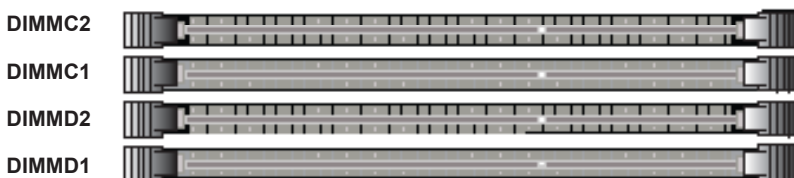

## Memory Support

The C9X299-PGF/-RPGF supports up to 128GB of Unbuffered (UDIMM) non-ECC DDR4 memory with speeds of up to 3000+MHz (OC) in four 288-pin memory slots. Populating these DIMM modules with a pair of memory modules of the same type and same size will result in interleaved memory, which will improve memory performance.



**Note:** Use memory modules of the same type and speed on the motherboard. Mixing memory modules of different types is not allowed.

## Memory Population Guidelines

When installing memory modules, always use DDR4 DIMM modules of the same size, type, and speed. Mixed DIMM speeds can be installed. However, all DIMMs will run at the speed of the slowest DIMM.

Depending on which CPU is installed, DIMMs should be installed in the following configurations for optimized performance:

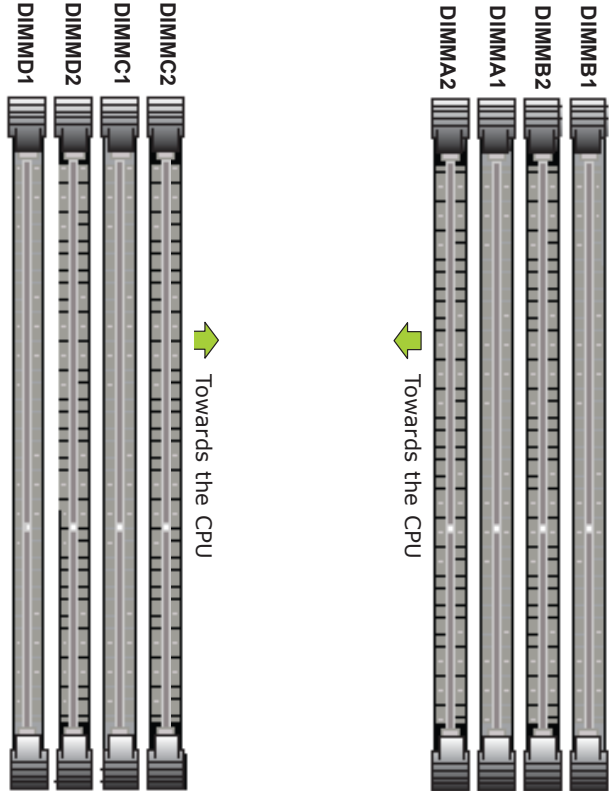

|   |         |            |         |
|---|---------|------------|---------|
| Core™<br>X-Series<br>(6-core or<br>above) | ○ ○ ○ ○ | One DIMM   | ○ ● ○ ○ |
|   | ○ ○ ○ ○ | Two DIMM   | ○ ● ○ ● |
|   | ● ○ ● ○ | Four DIMM  | ○ ● ○ ● |
|   | ● ○ ● ○ | Six DIMM   | ● ● ● ● |
|   | ● ● ● ● | Eight DIMM | ● ● ● ● |
| Core™<br>X-Series<br>(4-core)             | ○ ○ ● ○ | One DIMM   | ○ ○ ○ ○ |
|   | ● ○ ● ○ | Two DIMM   | ○ ○ ○ ○ |
|   | ● ● ● ● | Four DIMM  | ○ ○ ○ ○ |

## 2-5 Motherboard Installation

All motherboards have standard mounting holes to fit different types of chassis. Make sure that the locations of all the mounting holes for both motherboard and chassis match. Although a chassis may have both plastic and metal mounting fasteners, metal ones are highly recommended because they ground the motherboard to the chassis. Make sure that the metal standoffs click in or are screwed in tightly. Then use a screwdriver to secure the motherboard onto the motherboard tray.

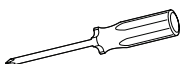

Phillips Screwdriver (1)



Phillips Screws (9)



Standoffs (9)  
Only if Needed

### Tools Needed

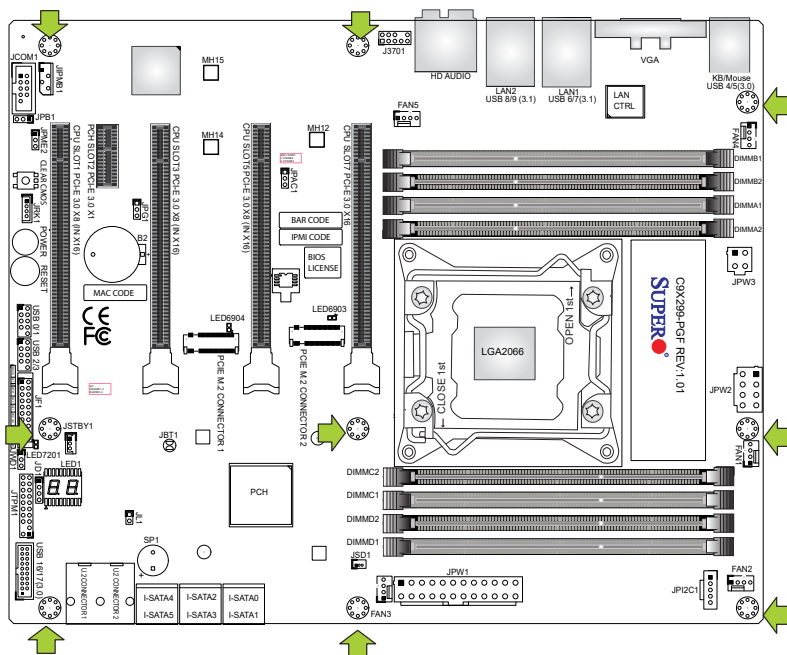

### Location of Mounting Holes

- Attention!** 1) To avoid damaging the motherboard and its components, please do not use a force greater than 8 lb/inch on each mounting screw during motherboard installation. 2) Some components are very close to the mounting holes. Please take precautionary measures to avoid damaging these components when installing the motherboard to the chassis.

## Installing the Motherboard

1. Install the I/O shield into the back of the chassis.

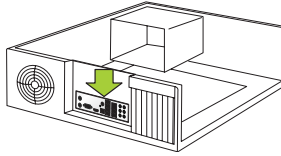

2. Locate the mounting holes on the motherboard. (See the previous page.)
3. Locate the matching mounting holes on the chassis. Align the mounting holes on the motherboard against the mounting holes on the chassis.

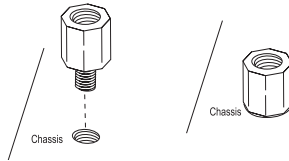

4. Install standoffs in the chassis as needed.
5. Install the motherboard into the chassis carefully to avoid damaging other motherboard components.

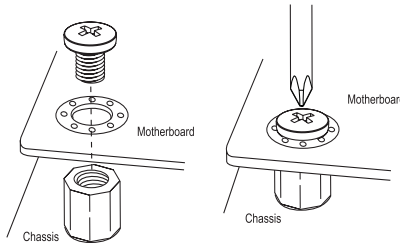

6. Using the Phillips screwdriver, insert a Phillips head #6 screw into a mounting hole on the motherboard and its matching mounting hole on the chassis.
7. Repeat Step 6 to insert #6 screws into all mounting holes.
8. Make sure that the motherboard is securely placed in the chassis.



**Note:** Images displayed are for illustration only. Your chassis or components might look different from those shown in this manual.

## 2-6 M.2 Installation (optional)

Two M.2 (M-key) connectors are supported by the C9X299-PGF/-RPGF. M.2 devices are used for solid state storage and internal expansion. Follow the steps below in order to install an M.2 device.

- 1) Locate one of two standoffs. Remove and set aside screw.

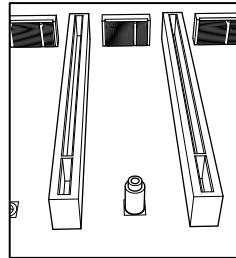

- 2) Plug M.2 device into M.2 connector and lower the semi-circle notched end onto standoff.

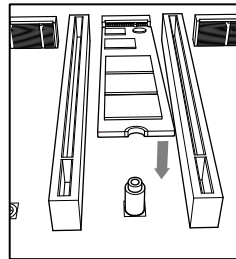

- 3) Replace screw and tighten to secure M.2 device into place. Do not over-tighten so as to avoid damaging the M.2 device.

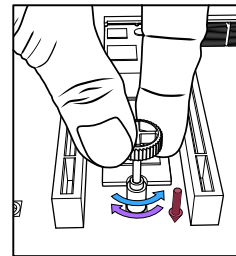

## 2-7 Connectors/I/O Ports

The I/O ports are color coded in conformance with the industry standards. See the figure below for the colors and locations of the various I/O ports.

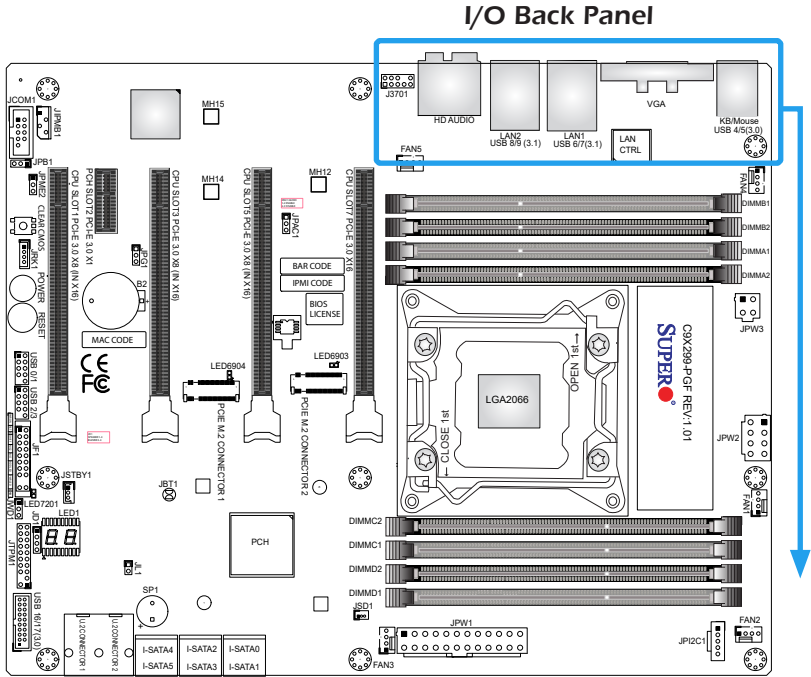

|   |                     |   |                         |   |                |   |        |
|---|---------------------|---|-------------------------|---|----------------|---|--------|
| A | PS/2 Keyboard/Mouse | F | USB 3.1 Port 6          | K | Center/LFE Out | P | Mic In |
| B | USB 3.0 Port 4      | G | USB 3.1 Port 7          | L | Surround Out   |   |        |
| C | USB 3.0 Port 5      | H | GB LAN Port 2           | M | S/PDIF Out     |   |        |
| D | VGA                 | I | USB 3.1 Port 8 (Type A) | N | Line In        |   |        |
| E | 5G LAN Port 1       | J | USB 3.1 Port 9 (Type C) | O | Line Out       |   |        |

### C9X299-PGF

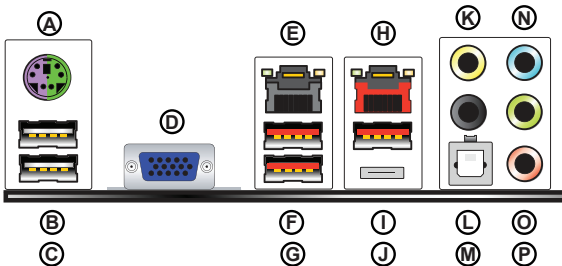

## Universal Serial Bus (USB)

Two USB 3.0 ports (USB4/5), four USB 3.1 ports (USB6/7, USB8: Type A, USB9: Type C) are on the I/O back panel. Additionally, two USB 2.0 headers (USB0/1, USB2/3) and one USB 3.0 header (USB16/17) are located on the motherboard to provide front chassis access using USB cables (not included). Refer to the tables below for pin definitions.

| Front Panel USB (2.0) Header #0/1/2/3<br>Pin Definitions |            |       |            |
|--|------------|-------|------------|
| Pin#   | Definition | Pin # | Definition |
| 1  | +5V        | 2     | +5V        |
| 3  | USB_PN2    | 4     | USB_PN3    |
| 5  | USB_PP2    | 6     | USB_PP3    |
| 7  | Ground     | 8     | Ground     |
| 9  | Key        | 10    | Ground     |

| Back Panel USB (2.0) #0/1, USB (3.1)<br>#8/9/10/11 Pin Definitions |            |      |            |
|--|------------|------|------------|
| Pin#   | Definition | Pin# | Definition |
| 1  | +5V        | 5    | +5V        |
| 2  | USB_PN1    | 6    | USB_PN0    |
| 3  | USB_PP1    | 7    | USB_PP0    |
| 4  | Ground     | 8    | Ground     |

| Front Panel USB (3.0) Header #16/17<br>Pin Definitions |      |             |                           |
|--|------|-------------|---------------------------|
| Pin#   | Pin# | Signal Name | Description               |
| 1  | 19   | VBUS        | Power                     |
| 2  | 18   | StdA_SSRX-  | SuperSpeed Receiver       |
| 3  | 17   | StdA_SSRX+  | Differential Pair         |
| 4  | 16   | Ground      | Ground of PWR Return      |
| 5  | 15   | StdA_SSTX-  | SuperSpeed Transmitter    |
| 6  | 14   | StdA_SSTX+  | Differential Pair         |
| 7  | 13   | GND_DRAIN   | Ground for Signal Return  |
| 8  | 12   | D-          | USB 2.0 Differential Pair |
| 9  | 11   | D+          | USB 2.0 Differential Pair |

- A. Back panel USB4
- B. Back panel USB5
- C. Back panel USB6
- D. Back panel USB7
- E. Back panel USB8
- F. Back panel USB9
- G. USB0/1
- H. USB2/3
- I. USB16/17

### C9X299-PGF

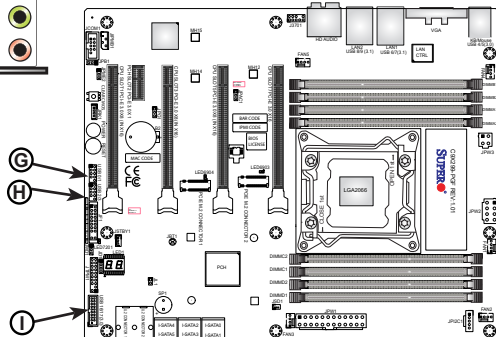
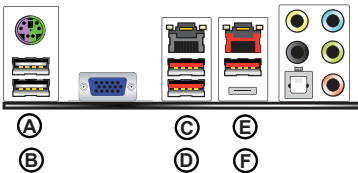

### Ethernet Port

There are two Gigabit Ethernet ports (LAN) on the I/O back panel to provide network connections. These ports accept RJ45 type cables.



**Note:** Please refer to the LED Indicator Section for LAN LED information.

| LAN1 Port<br>Pin Definition |            |      |            |
|-----------------------------|------------|------|------------|
| Pin#                        | Definition | Pin# | Definition |
| 19                          | VCC        | 29   | ORG-/GRN+  |
| 20                          | TX1+       | 30   | ORG+/GRN-  |
| 21                          | TX1-       | 31   | YEL+       |
| 22                          | TX2+       | 32   | YEL-       |
| 23                          | TX2-       | 33   | CG5        |
| 24                          | TX3+       | 34   | CG6        |
| 25                          | TX3-       | 35   | CG7        |
| 26                          | TD4+       | 36   | CG8        |
| 27                          | TD4-       |      |            |
| 28                          | GND        |      |            |

| LAN2 Port<br>Pin Definition |            |      |            |
|-----------------------------|------------|------|------------|
| Pin#                        | Definition | Pin# | Definition |
| 10                          | VCC        | 19   | GND        |
| 11                          | MD1P       | 20   | GRE+/ORG-  |
| 12                          | MD1N       | 21   | GRE-/ORG+  |
| 13                          | MD2P       | 22   | YEL+       |
| 14                          | MD2N       | 23   | YEL-       |
| 15                          | MD3P       |      |            |
| 16                          | MD3N       | G1   | CG1        |
| 17                          | MD4P       | G2   | CG2        |
| 18                          | MD4N       |      |            |

- A. LAN1
- B. LAN2

### C9X299-PGF

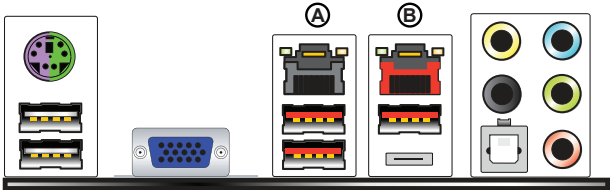

### ATX PS/2 Keyboard/Mouse Port

The ATX PS/2 keyboard and mouse port is located on the back panel above USB Ports 4/5.

### VGA Port

A VGA port is located on the I/O back panel. Use this port to connect to a compatible VGA display.

### HD AUDIO Ports

This motherboard features a 7.1+2 Channel High Definition Audio (HDA) codec that provides 10 DAC channels. The HD Audio connections on the I/O back panel simultaneously supports multiple-streaming 7.1 sound playback with two channels of independent stereo output through the front panel stereo out for front, rear, center and subwoofer speakers. Use the Advanced software included in the CD-ROM with your motherboard to enable this function.

- A. PS/2 Keyboard/Mouse Port
- B. VGA Port
- C. Center/LFE Out
- D. Surround Out
- E. S/PDIF Out
- F. Line In
- G. Line Out
- H. Mic In

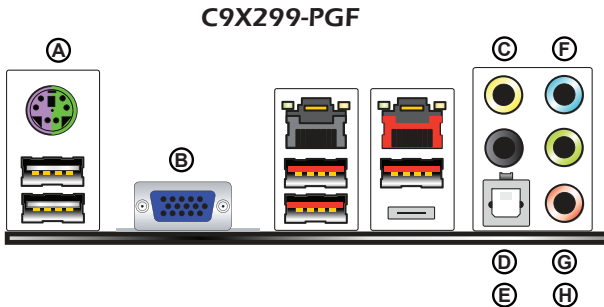

## Front Control Panel

JF1 contains header pins for various buttons and indicators that are normally located on a control panel at the front of the chassis. These connectors are designed specifically for use with Supermicro chassis. See the figure below for the descriptions of the front control panel buttons and LED indicators. Refer to the following section for descriptions and pin definitions.

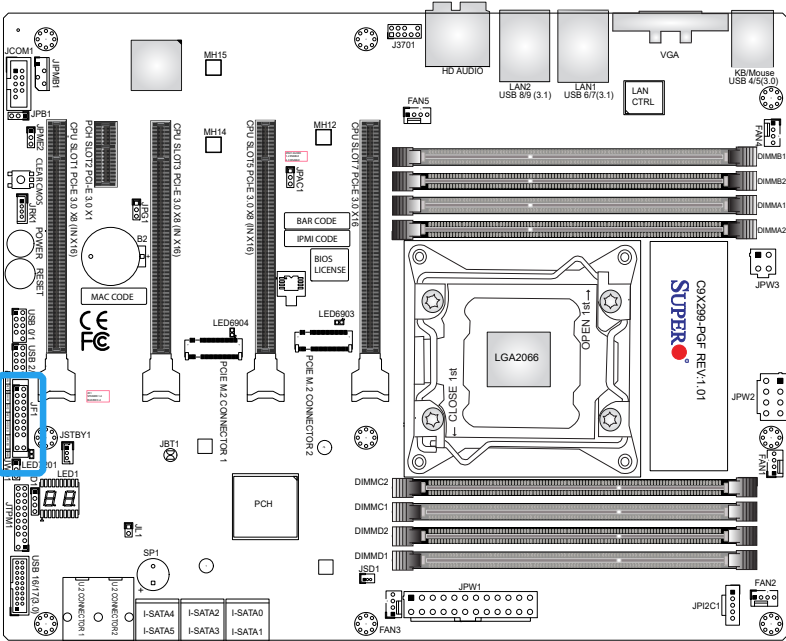

### JF1 Header Pins

|              | 1  | 2  |                 |
|--------------|----|----|-----------------|
| Power Button | ○  | ○  | Ground          |
| Reset Button | ○  | ○  | Ground          |
| Vcc          | ○  | ○  | Power Fail LED  |
| Vcc          | ○  | ○  | OH/Fan Fail LED |
| Vcc          | ○  | ○  | NIC2 LED        |
| Vcc          | ○  | ○  | NIC1 LED        |
| Vcc          | ○  | ○  | HDD LED         |
| Vcc          | ○  | ○  | Power LED       |
| X            | ○  | ○  | X               |
| NMI          | ○  | ○  | Ground          |
|              | 19 | 20 |                 |

## Front Control Panel Pin Definitions

### Power LED

The Power LED connection is located on pins 15 and 16 of JF1. Refer to the table on the right for pin definitions.

| Power LED<br>Pin Definitions (JF1) |            |
|------------------------------------|------------|
| Pin#                               | Definition |
| 15                                 | Vcc        |
| 16                                 | PWR LED    |

### HDD LED

The HDD LED connection is located on pins 13 and 14 of JF1. Attach a cable here to indicate the status of HDD-related activities, including IDE and SATA activities. Refer to the table on the right for pin definitions.

| HDD LED<br>Pin Definitions (JF1) |            |
|----------------------------------|------------|
| Pin#                             | Definition |
| 13                               | Vcc        |
| 14                               | HD Active  |

### NIC1/NIC2 Activity LED

The NIC (Network Interface Controller) LED connection for LAN port 1 is located on pins 11 and 12 of JF1, and the LED connection for LAN Port 2 is on pins 9 and 10. Attach NIC LED cables to NIC1 and NIC2 LED indicators to display network activities. Refer to the table on the right for pin definitions.

| LAN LED<br>Pin Definitions (JF1) |               |
|----------------------------------|---------------|
| Pin#                             | Definition    |
| 9/11                             | Vcc           |
| 10/12                            | NIC2/NIC1 LED |

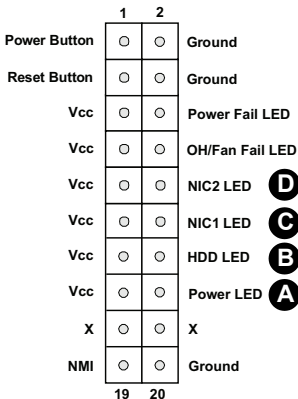

- A. PWR LED
- B. HDD LED
- C. NIC1 LED
- D. NIC2 LED

## Overheat (OH)/Fan Fail

Connect an LED cable to OH/Fan Fail connections on pins 7 and 8 of JF1 to provide warnings for chassis overheat/fan failure. Refer to the table on the right for pin definitions.

| OH/Fan Fail LED Pin Definitions (JF1) |                 |
|---------------------------------------|-----------------|
| Pin#                                  | Definition      |
| 7                                     | Vcc             |
| 8                                     | OH/Fan Fail LED |

| OH/Fan Fail Indicator Status |            |
|------------------------------|------------|
| State                        | Definition |
| Off                          | Normal     |
| On                           | Overheat   |
| Flashing                     | Fan Fail   |

## Power Fail LED

The Power Fail LED connection is located on pins 5 and 6 of JF1. Refer to the table below for pin definitions.

| Power Fail LED Pin Definitions (JF1) |               |
|--------------------------------------|---------------|
| Pin#                                 | Definition    |
| 5                                    | No Connection |
| 6                                    | Power Fail    |

|              | 1  | 2  |                          |
|--------------|----|----|--------------------------|
| Power Button | ○  | ○  | Ground                   |
| Reset Button | ○  | ○  | Ground                   |
| Vcc          | ○  | ○  | Power Fail LED <b>B</b>  |
| Vcc          | ○  | ○  | OH/Fan Fail LED <b>A</b> |
| Vcc          | ○  | ○  | NIC2 LED                 |
| Vcc          | ○  | ○  | NIC1 LED                 |
| Vcc          | ○  | ○  | HDD LED                  |
| Vcc          | ○  | ○  | Power LED                |
| X            | ○  | ○  | X                        |
| NMI          | ○  | ○  | Ground                   |
|              | 19 | 20 |                          |

- A. Overheat/Fan Fail
- B. Power Fail

### Power Button

The Power Button connection is located on pins 1 and 2 of JF1. Momentarily contacting both pins will power on/off the system. This button can also be configured to function as a suspend button (with a setting in the BIOS - see Chapter 4). To turn off the power in the suspend mode, press the button for at least 4 seconds. Refer to the table on the right for pin definitions.

| Power Button Pin Definitions (JF1) |            |
|------------------------------------|------------|
| Pin#                               | Definition |
| 1                                  | Signal     |
| 2                                  | Ground     |

### Reset Button

The Reset Button connection is located on pins 3 and 4 of JF1. Attach it to a hardware reset switch on the computer case to reset the system. Refer to the table on the right for pin definitions.

| Reset Button Pin Definitions (JF1) |            |
|------------------------------------|------------|
| Pin#                               | Definition |
| 3                                  | Reset      |
| 4                                  | Ground     |

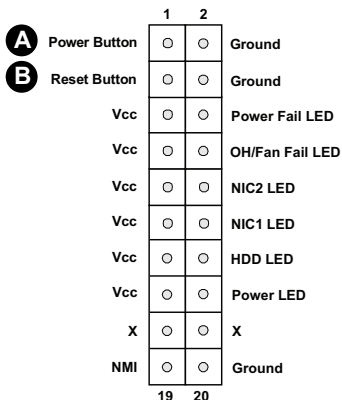

- A. Power Button
- B. Reset Button

## 2-8 Connecting Cables

This section provides brief descriptions and pin-out definitions for on-board headers and connectors. Be sure to use the correct cable for each header or connector.

### ATX Main PWR and CPU PWR Connectors

The 24-pin main power connector (JPW1) provides power to the motherboard. The 8-pin CPU PWR connector (JPW2) is also required for the processor. The 4-pin PWR connector (JPW3) is optional. These power connectors meet the SSI EPS 12V specification. Refer to the table on the right for pin definitions.

| Pin# | Definition | Pin# | Definition |
|------|------------|------|------------|
| 13   | +3.3V      | 1    | +3.3V      |
| 14   | -12V       | 2    | +3.3V      |
| 15   | COM        | 3    | COM        |
| 16   | PS_ON      | 4    | +5V        |
| 17   | COM        | 5    | COM        |
| 18   | COM        | 6    | +5V        |
| 19   | COM        | 7    | COM        |
| 20   | Res (NC)   | 8    | PWR_OK     |
| 21   | +5V        | 9    | 5VSB       |
| 22   | +5V        | 10   | +12V       |
| 23   | +5V        | 11   | +12V       |
| 24   | COM        | 12   | +3.3V      |

| Pins    | Definition |
|---------|------------|
| 1 and 2 | Ground     |
| 3 and 4 | +12V       |

| Pins        | Definition |
|-------------|------------|
| 1 through 4 | Ground     |
| 5 through 8 | +12V       |

(Required)

- A. 24-Pin ATX Main PWR
- B. 8-Pin PWR
- C. 4-pin PWR

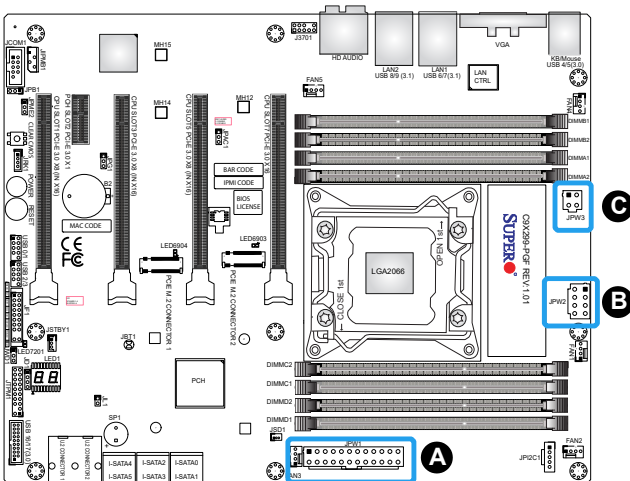

## Fan Headers

The motherboard has five 4-pin fan headers (FAN1 ~ FAN5). Although pins 1-3 of the fan headers are backward compatible with the traditional 3-pin fans, we recommend using 4-pin fans to take advantage of the fan speed control. This allows the fan speeds to be automatically adjusted based on the motherboard temperature. Refer to the table on the right for pin definitions.

| Fan Header Pin Definitions |                 |
|----------------------------|-----------------|
| Pin#                       | Definition      |
| 1                          | Ground (Black)  |
| 2                          | 2.5A/+12V (Red) |
| 3                          | Tachometer      |
| 4                          | PWM_Control     |

## Chassis Intrusion

A Chassis Intrusion header is located at JL1 on the motherboard. Attach the appropriate cable from the chassis to inform you of a chassis intrusion when the chassis is opened.

| Chassis Intrusion Pin Definitions |                 |
|-----------------------------------|-----------------|
| Pin#                              | Definition      |
| 1                                 | Intrusion Input |
| 2                                 | Ground          |

- A. FAN1 (CPU Fan)
- B. FAN2 (CPU Fan)
- C. FAN3
- D. FAN4
- E. FAN5
- F. Chassis Intrusion

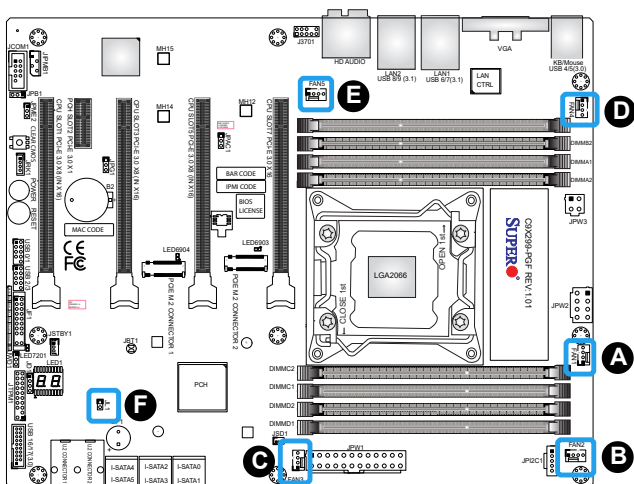

### Internal Buzzer/Speaker

The Internal Buzzer (SP1) can be used to provide audible indications for various beep codes. Refer to the table on the right for pin definitions.

| Internal Buzzer<br>Pin Definition |             |               |
|-----------------------------------|-------------|---------------|
| Pin#                              | Definitions |               |
| Pin 1                             | Pos. (+)    | Beep In       |
| Pin 2                             | Neg. (-)    | Alarm Speaker |

### Speaker

On the JD1 header, pins 3-4 are used for a buzzer. If you wish to use an external speaker, close pins 1-4 with a cable. Refer to the table on the right for pin definitions.

| Speaker Connector<br>Pin Definitions |                  |
|--------------------------------------|------------------|
| Pin Setting                          | Definition       |
| Pins 3~4                             | Buzzer           |
| Pins 1~4                             | External Speaker |

- A. Internal Buzzer
- B. Speaker Header

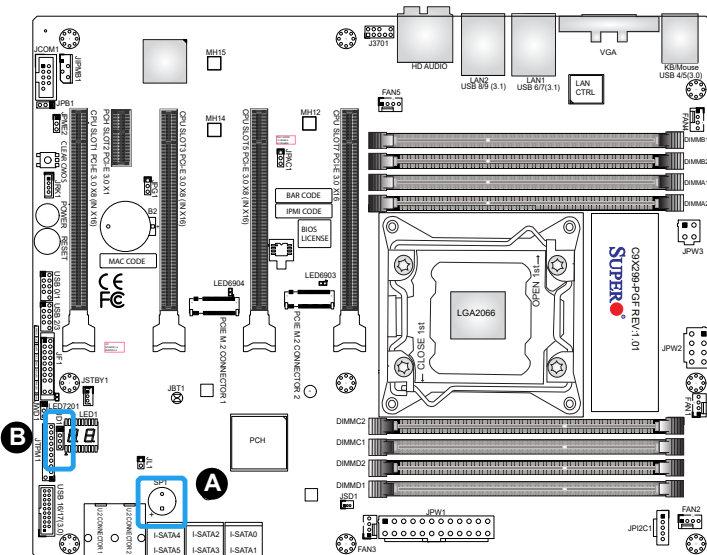

### Serial Port

There is one serial (COM) header on the motherboard. JCOM1 is located next to the PCI-E slot 1. Refer to the table on the right for pin definitions.

| Serial/COM Port Pin Definitions |            |       |            |
|---------------------------------|------------|-------|------------|
| Pin#                            | Definition | Pin # | Definition |
| 1                               | DCD        | 6     | DSR        |
| 2                               | RXD        | 7     | RTS        |
| 3                               | TXD        | 8     | CTS        |
| 4                               | DTR        | 9     | RI         |
| 5                               | Ground     | 10    | N/A        |

### 4-pin External BMC I<sup>2</sup>C Header

A System Management Bus header for IPMI 2.0 is located at JIPMB1. Connect a cable to this header to use the IPMB I<sup>2</sup>C connection on your system. Refer to the table on the right for pin definitions.

| External I <sup>2</sup> C Header Pin Definitions |               |
|--|---------------|
| Pin#   | Definition    |
| 1  | Data          |
| 2  | Ground        |
| 3  | Clock         |
| 4  | No Connection |

A. JCOM1

B. 4-pin External BMC Header

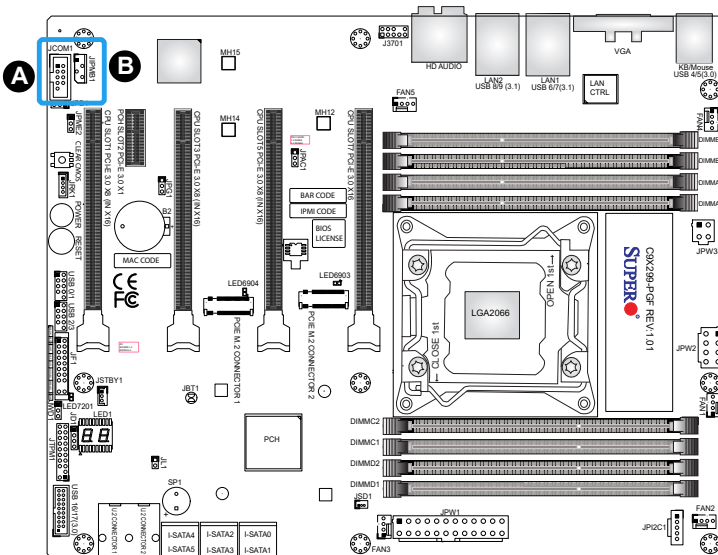

### DOM PWR Connector

The Disk-On-Module (DOM) power connector, located at JSD1, provides 5V power to a solid state DOM storage device connected to one of the SATA ports. Refer to the table on the right for pin definitions.

| DOM PWR Pin Definitions |            |
|-------------------------|------------|
| Pin#                    | Definition |
| 1                       | 5V         |
| 2                       | Ground     |
| 3                       | Ground     |

### Intel RAID Key Header

The JRK1 header allows the user to enable RAID functions. Refer to the table on the right for pin definitions.

| Intel RAID Key Pin Definitions |               |
|--------------------------------|---------------|
| Pin#                           | Definition    |
| 1                              | GND           |
| 2                              | PU 3.3V Stdby |
| 3                              | GND           |
| 4                              | PCH RAID KEY  |

- A. DOM PWR
- B. RAID Key Header

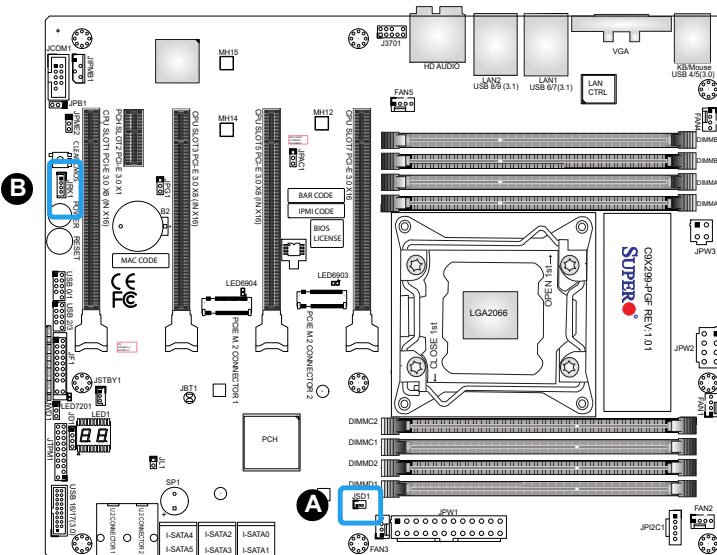

## U.2 SSD Connectors

The two U.2 SSD connectors (U.2 Connector 1, U.2 Connector 2) on the board support Solid State Drives (SSD) and are connected directly to the motherboard. They offer up to 4x PCI 3.0 lanes to a connected SSD device.

## M.2 Connectors

M.2 was formerly known as Next Generation Form Factor (NGFF). The two M.2 connectors are designed for internal mounting devices and provide M-Key 2280/22120 (M.2 #1) and 2280 (M.2 #2) dedicated support for SSD devices with the ultimate performance capability in a PCI Express 3.0 interface for native PCI-E SSD support. Refer to page 2-14 for installation guidelines.

- A. U.2 Connector 1
- B. U.2 Connector 2
- C. PCI-E M.2 Connector 1
- D. PCI-E M.2 Connector 2

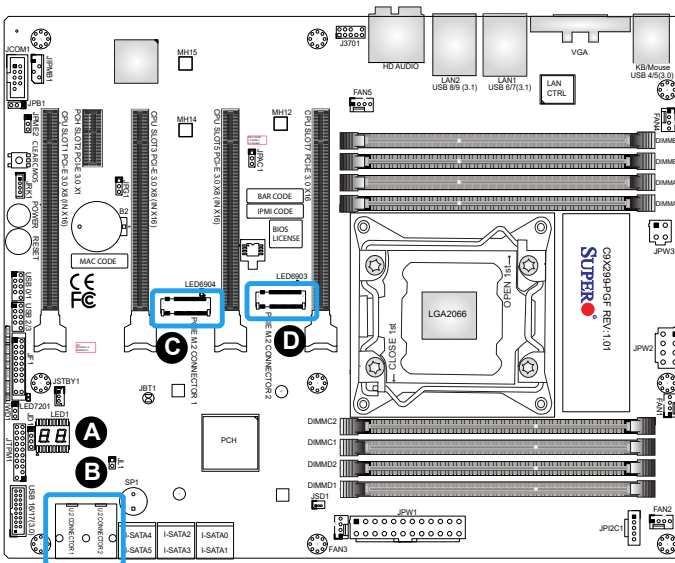

### Front Panel Audio Header

A 10-pin Audio header at J3701 is supported on the motherboard. This header allows you to connect the motherboard to a front panel audio control panel, if needed. Connect an audio cable to the audio header to use this feature (not supplied). Refer to the table on the right for pin definitions.

| 10-in Audio Pin Definitions |                  |
|-----------------------------|------------------|
| Pin#                        | Signal           |
| 1                           | Microphone_Left  |
| 2                           | Audio_Ground     |
| 3                           | Microphone_Right |
| 4                           | Audio_Detect     |
| 5                           | Line_2_Right     |
| 6                           | Ground           |
| 7                           | Jack_Detect      |
| 8                           | Key              |
| 9                           | Line_2_Left      |
| 10                          | Ground           |

### TPM Header/Port 80

A Trusted Platform Module/Port 80 header is located at JTPM1 to provide TPM support and Port 80 connection. Use this header to enhance system performance and data security. Refer to the table on the right for pin definitions.

| TPM/Port 80 Header Pin Definitions |            |      |             |
|------------------------------------|------------|------|-------------|
| Pin#                               | Definition | Pin# | Definition  |
| 1                                  | LCLK       | 2    | GND         |
| 3                                  | LFRAME#    | 4    | <(KEY)>     |
| 5                                  | LRESET#    | 6    | +5V (X)     |
| 7                                  | LAD 3      | 8    | LAD 2       |
| 9                                  | +3.3V      | 10   | LAD1        |
| 11                                 | LAD0       | 12   | GND         |
| 13                                 | SMB_CLK4   | 14   | SMB_DAT4    |
| 15                                 | +3V_DUAL   | 16   | SERIRQ      |
| 17                                 | GND        | 18   | CLKRUN# (X) |
| 19                                 | LPCPD#     | 20   | LDRQ# (X)   |

- A. AUDIO FP
- B. TPM Header

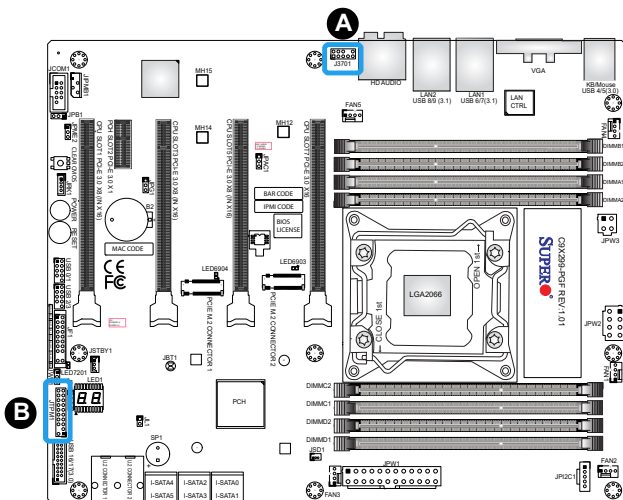

### Standby Power Header

The Standby Power header is located at JSTBY1 on the motherboard. Refer to the table on the right for pin definitions.

| Standby Power Pin Definitions |             |
|-------------------------------|-------------|
| Pin#                          | Definition  |
| 1                             | +5V Standby |
| 2                             | Ground      |
| 3                             | Wake-up     |

### Power SMB (I<sup>2</sup>C) Header

Power System Management Bus header at JPI<sup>2</sup>C1 monitors the power supply, fan and system temperatures. Refer to the table on the right for pin definitions.

| Power SMB Pin Definitions |            |
|---------------------------|------------|
| Pin#                      | Definition |
| 1                         | Clock      |
| 2                         | Data       |
| 3                         | Power Fail |
| 4                         | Ground     |
| 5                         | +3.3V      |

- A. JSTBY1
- B. JPI<sup>2</sup>C1

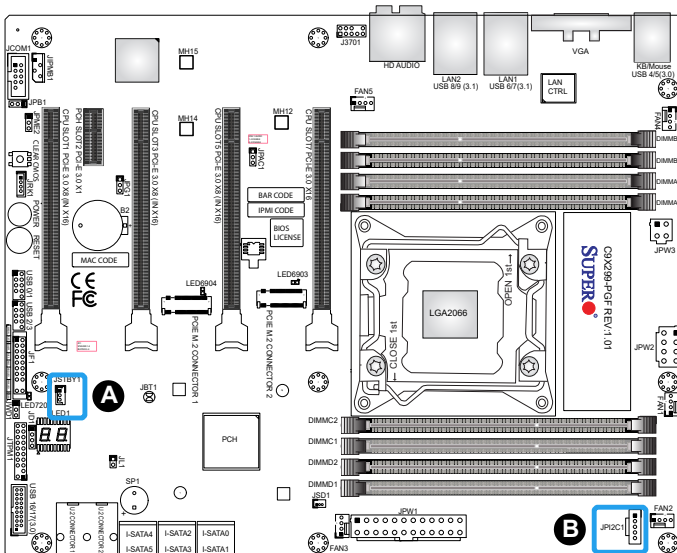

## 2-9 Jumper Settings

### Explanation of Jumpers

To modify the operation of the motherboard, jumpers can be used to choose between optional settings. Jumpers create shorts between two pins to change the function of the connector. Pin 1 is identified with a square solder pad on the printed circuit board.



**Note:** On two-pin jumpers, Closed means the jumper is on, and Open means the jumper is off the pins.

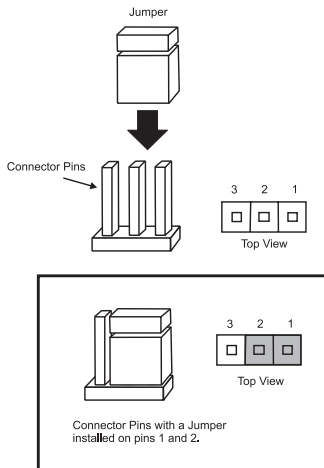

## Clear CMOS & JBT1

Clear CMOS and JBT1 are used to clear the saved system setup configuration stored in the CMOS chip. To clear the contents of the CMOS using JBT1, short the two pads of JBT1 with a metallic conductor such as a flathead screwdriver. Clear CMOS works the same way but is a push button switch. This will erase all user settings and revert everything to their factory defaults.

## Watch Dog Timer Enable/Disable

Watch Dog (JWD1) is a system monitor that can reboot the system when a software application hangs. Close pins 1-2 to reset the system if an application hangs. Close pins 2-3 to generate a non-maskable interrupt signal for the application that hangs. Refer to the table on the right for jumper settings.

| Watch Dog Jumper Settings |                 |
|---------------------------|-----------------|
| Pin#                      | Definition      |
| 1-2                       | Reset (default) |
| 2-3                       | NMI             |
| Open                      | Disabled        |

- A. JBT1
- B. Clear CMOS
- C. Watch Dog Timer

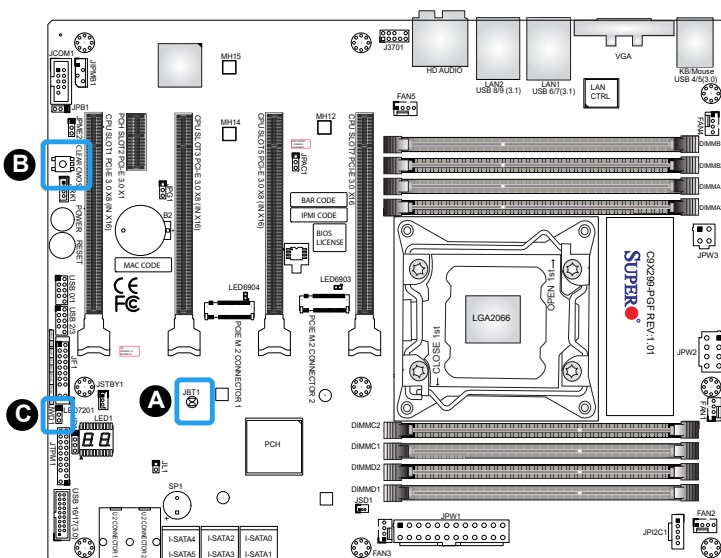

## Manufacturing Mode

Close pins 2-3 of jumper JPME2 to bypass SPI flash security and force the system to operate in Manufacturing Mode, allowing the user to flash the system firmware from a host server for system setting modifications. Refer to the table on the right for jumper settings.

| Manufacturing Mode Jumper Settings |                    |
|------------------------------------|--------------------|
| Pin#                               | Definition         |
| 1-2                                | Normal (Default)   |
| 2-3                                | Manufacturing Mode |

## Audio Enable

JPAC1 allows you to enable or disable the onboard audio support. The default position is on pins 1-2 to enable onboard audio connections. Refer to the table on the right for jumper settings.

| Audio Enable/Disable Jumper Settings |            |
|--------------------------------------|------------|
| Pin#                                 | Definition |
| 1-2                                  | Enabled    |
| 2-3                                  | Disabled   |

- A. Manufacturing Mode
- B. Audio Enable

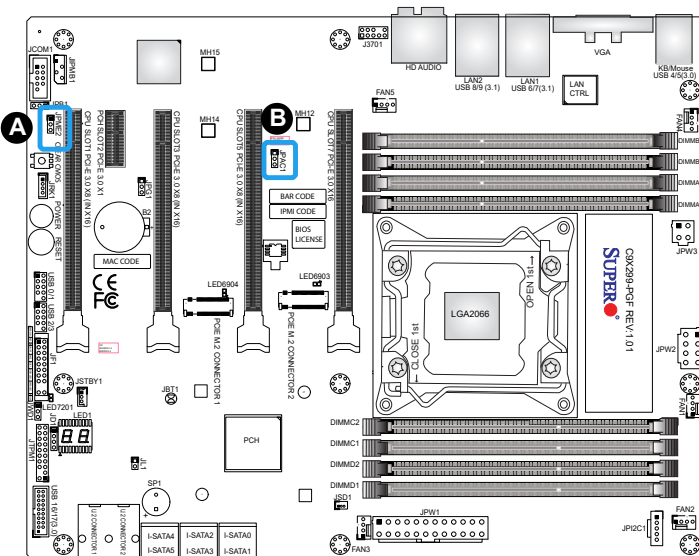

## Power Button

In addition to the soft power switch provided in JF1, the motherboard is equipped with a soft power button on the motherboard. This switch works the same way as the soft power switch on JF1.

## Reset Button

When pressed, the Reset Button will reset the system and reboot. This action will erase everything in memory and restart the system.

- A. Power Button
- B. Reset Button

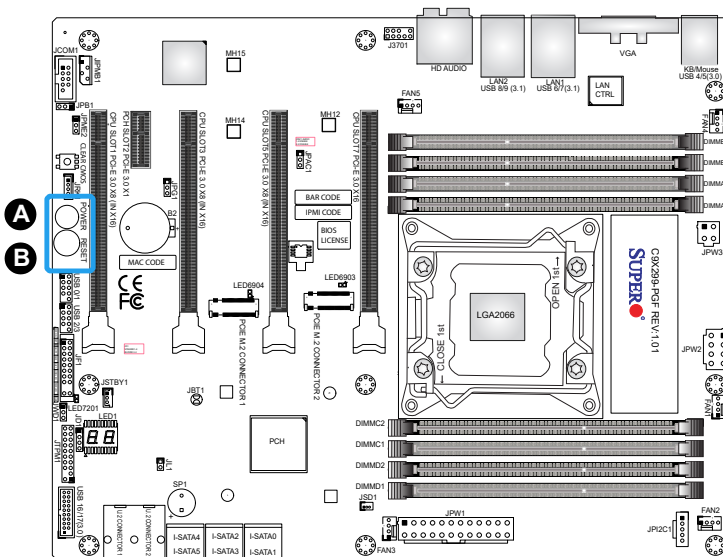

### VGA Enable/Disable

JPG1 allows you to enable or disable the VGA port using the onboard graphics controller. The default setting is **Enabled**.

| VGA Enable/Disable Jumper Settings |            |
|------------------------------------|------------|
| Pin#                               | Definition |
| 1-2                                | Enabled    |
| 2-3                                | Disabled   |

### BMC Enabled

JPB1 allows you to enable or disable the BMC (Baseboard Management Control) chip and the onboard IPMI connection for remote system management/monitoring purpose. This jumper is used together with the IPMI settings in the BIOS. After the BMC is disabled, IPMI health monitoring and remote management functions are no longer supported.

**Note:** Please always keep BMC enabled to make sure the platform operates reliably with the health monitor.

| BMC Enable Jumper Settings |                   |
|----------------------------|-------------------|
| Jumper Setting             | Definition        |
| Pins 1-2                   | Enabled (Default) |
| Pins 2-3                   | Disabled          |

- A. VGA Enable/Disable
- B. BMC Enable/Disable

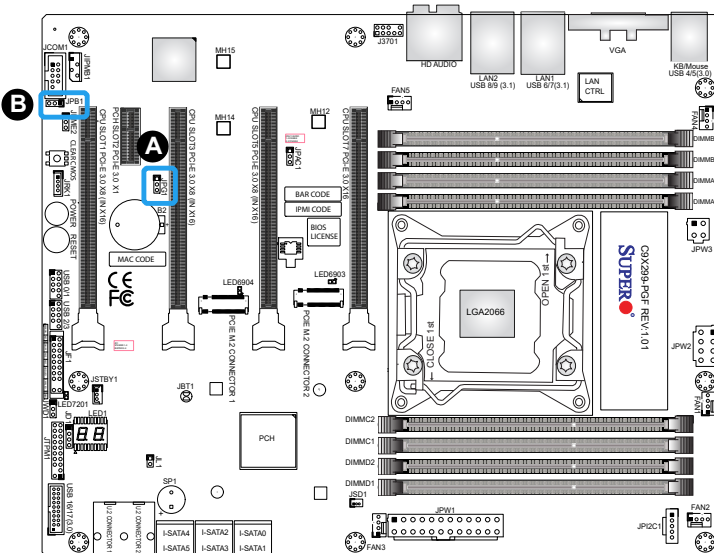

## 2-10 Onboard Indicators

### LAN LEDs

Two LAN ports are on the I/O back panel. These Ethernet LAN ports have two LEDs (Light Emitting Diode). The yellow LED indicates activity, while the Link LED may be green, amber, or off to indicate the speed of the connections. Refer to the tables on the right for more information.

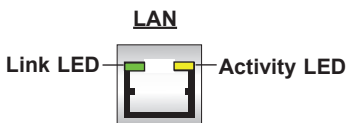

| GLAN Activity Indicator LED Settings |          |             |
|--------------------------------------|----------|-------------|
| Color                                | Status   | Definition  |
| Green                                | Blinking | Activity    |
| Green                                | Solid    | No Activity |

| GLAN Link Indicator LED Settings |                       |
|----------------------------------|-----------------------|
| LED Color                        | Definition            |
| Off                              | No Connection         |
| Amber                            | 2.5Gbps/1Gbps/100Mbps |
| Green                            | 5 Gbps                |

### Onboard Power LED

An Onboard Power LED is located at LED7201. When this LED is on, the AC power cable is connected. Make sure to disconnect the power cable before removing or installing a component.

| Onboard PWR LED Indicator LED Status |  |
|--------------------------------------|--|
| Status                               | Definition                                       |
| Off                                  | System Off                                       |
| Solid Green                          | System on, or System off and PWR Cable Connected |

A. LAN LEDs

B. Onboard Power LED

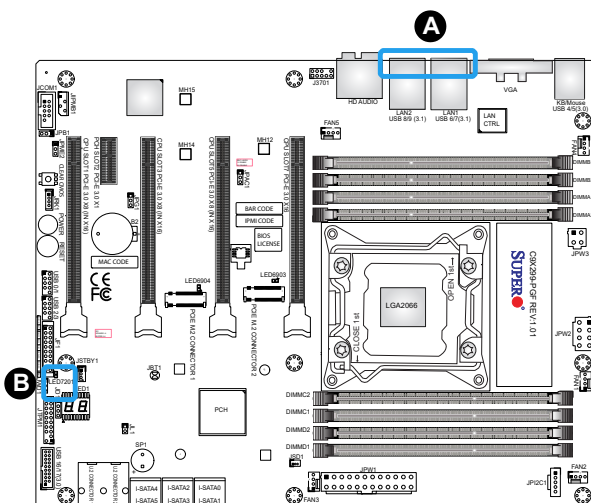

## Status Display

LED1 is made up of two alpha-numeric displays that will display a status or POST code, when the motherboard is powered on. Please download the following AMI publication for a complete list of POST codes:

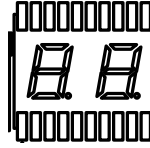

[https://ami.com/ami\\_downloads/Aptio\\_V\\_Status\\_Codes.pdf](https://ami.com/ami_downloads/Aptio_V_Status_Codes.pdf)

## M.2 Activity LEDs

There are two M.2 LEDs. LED6903 is the activity LED for M.2 connector 1, and LED6904 is the activity LED for M.2 connector 2. When the LED is blinking, M.2 functions normally.

| M.2 LED LED Status |                   |
|--------------------|-------------------|
| Status             | Definition        |
| Blinking Green     | Device is working |

- A. Status Code LED
- B. M.2 Connector 1 Activity LED
- C. M.2 Connector 2 Activity LED

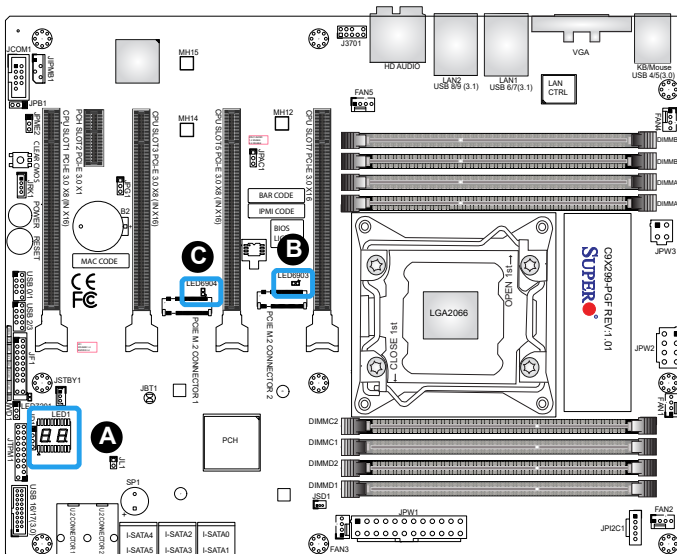

## 2-11 Hard Drive Connections

### SATA Connections (I-SATA0~I-SATA5)

Six Serial ATA (SATA) 3.0 connectors (I-SATA 0~5) are supported by the Intel X299 chip (supports RAID 0, 1, 5, 10). Refer to the table on the right for pin definitions.

| SATA 2.0/3.0 Connectors<br>Pin Definitions |          |
|--|----------|
| Pin#                                       | Signal   |
| 1  | Ground   |
| 2  | SATA_TXP |
| 3  | SATA_TXN |
| 4  | Ground   |
| 5  | SATA_RXN |
| 6  | SATA_RXP |
| 7  | Ground   |

### U.2 SSD Connectors

The two U.2 SSD connectors (U.2 Connector 1, U.2 Connector 2) on the board support Solid State Drives (SSD) and are connected directly to the motherboard. They offer up to 4x PCI 3.0 lanes to a connected SSD device.

- A. U.2 Connector 1
- B. U.2 Connector 2
- C. I-SATA4
- D. I-SATA5
- E. I-SATA2
- F. I-SATA3
- G. I-SATA0
- H. I-SATA1

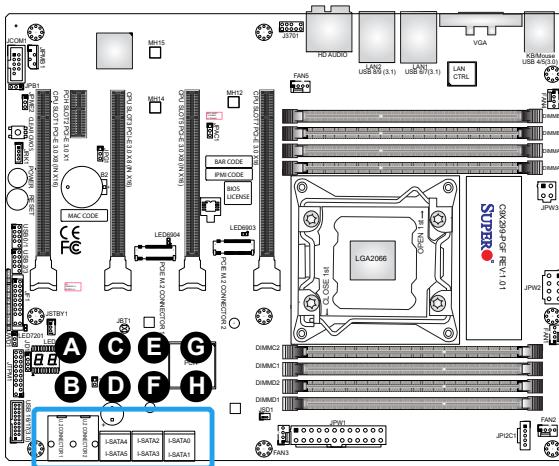

---

---

## Chapter 3

# Troubleshooting

### 3-1 Troubleshooting Procedures

Use the following procedures to troubleshoot your system. If you have followed all of the procedures below and still need assistance, refer to the 'Technical Support Procedures' and/or 'Returning Merchandise for Service' section(s) in this chapter. Always disconnect the AC power cord before adding, changing or installing any hardware components.

#### Before Power On

1. Make sure that the Standby PWR LED is not on.



**Note:** If it is on, the onboard power is on. Be sure to unplug the power cable before installing or removing the components.

2. Make sure that there are no short circuits between the motherboard and chassis.
3. Disconnect all ribbon/wire cables from the motherboard, including those for the keyboard and mouse. Also, be sure to remove all add-on cards.
4. Install a CPU and heatsink (be sure that it is fully seated) and then connect the chassis speaker and the power LED to the motherboard. Check all jumper settings as well.

#### No Power

1. Make sure that there are no short circuits between the motherboard and chassis.
2. Make sure that all jumpers are set to their default positions.
3. Check if the 115V/230V switch on the power supply is properly set.
4. Turn the power switch on and off to test the system.

5. The battery on your motherboard may be old. Check to make sure that it still supplies ~3VDC. If it does not, replace it with a new one.

### **No Video**

1. If the power is on, but you have no video. In this case, you will need to remove all the add-on cards and cables first.
2. Use the speaker to determine if any beep codes exist. (Refer to Appendix A for details on beep codes.)
3. Remove all memory modules and turn on the system. (If the alarm is on, check the specifications of memory modules, reset the memory or try a different one.)

### **Memory Errors**

1. Make sure that the DIMM modules are properly installed and fully seated in the slots.
2. You should be using unbuffered Non-ECC DDR4 (up to 4133MHz with overclocking) memory recommended by the manufacturer. Also, it is recommended that you use the memory modules of the same type and speed for all DIMMs in the system. Do not use memory modules of different size, speed, and type on the motherboard.
3. Check for bad DIMM modules or slots by swapping modules between slots to see if you can locate the faulty ones.
4. Check the switch of 115V/230V power supply.

### **When the System is Losing the Setup Configuration**

1. Please be sure to use a high quality power supply. A poor quality power supply may cause the system to lose CMOS setup information. Refer to Section 1-7 for details on recommended power supplies.
2. The battery on your motherboard may be old. Check to verify that it still supplies ~3VDC. If it does not, replace it with a new one.

3. If the above steps do not fix the Setup Configuration problem, contact your vendor for repairs.

## 3-2 Technical Support Procedures

Before contacting Technical Support, please make sure that you have followed all the steps listed below. Also, note that as a motherboard manufacturer, Supermicro does not sell directly to end users, so it is best to first check with your distributor or reseller for troubleshooting services. They should know of any possible problem(s) with the specific system configuration that was sold to you.

1. Please go through the 'Troubleshooting Procedures' and 'Frequently Asked Question' (FAQ) sections in this chapter or see the FAQs on our website (<http://www.supermicro.com/support/faqs/>) before contacting Technical Support.
2. BIOS upgrades can be downloaded from our website at (<http://www.supermicro.com/support/bios/>).



**Note:** Not all BIOS can be flashed. It depends on the boot block code of the BIOS.

3. If you've followed the instructions above to troubleshoot your system, and still cannot resolve the problem, then contact Supermicro's technical support and provide them with the following information:
  - Motherboard model and PCB revision number
  - BIOS release date/version (this can be seen on the initial display when your system first boots up)
  - System configuration
  - An example of a Technical Support form is on our website at (<http://www.supermicro.com/support/contact.cfm>).
4. Distributors: For immediate assistance, please have your account number ready when placing a call to our technical support department. We can be reached by e-mail at [support@supermicro.com](mailto:support@supermicro.com), by phone at: (408) 503-8000, option 2, or by fax at (408)503-8019.

### 3-3 Frequently Asked Questions

**Question:** What type of memory does my motherboard support?

**Answer:** The C9X299-PGF/-RPGF supports up to 128GB of unbuffered Non-ECC DDR4. See Section 2-4 for details on installing memory.

**Question:** How do I update my BIOS?

**Answer:** We do NOT recommend that you upgrade your BIOS if you are not experiencing any problems with your system. Updated BIOS files are located on our website at <http://www.supermicro.com/support/bios/>. Please check our BIOS warning message and the information on how to update your BIOS on our website. Select your motherboard model and download the BIOS ROM file to your computer. Also, check the current BIOS revision to make sure that it is newer than your BIOS before downloading. You may choose the zip file or the .exe file. If you choose the zipped BIOS file, please unzip the BIOS file onto a bootable device or a USB pen/thumb drive. To flash the BIOS, run the batch file named "ami.bat" with the new BIOS ROM file from your bootable device or USB pen/thumb drive. Use the following format:

```
F:\> ami.bat BIOS-ROM-filename.xxx <Enter>
```



**Note:** Always use the file named "ami.bat" to update the BIOS, and insert a space between "ami.bat" and the filename. The BIOS-ROM-filename will bear the motherboard name (i.e., C9X299) and build version as the extension. For example, "C9X299.115". When completed, your system will automatically reboot.

If you choose the .exe file, please run it under Windows to create the BIOS flash floppy disk. Insert the floppy disk into the system you wish to flash the BIOS. Then, boot the system to the floppy disk. The BIOS utility will automatically flash the BIOS without any prompts. Please note that this process may take a few minutes to complete. Do not be concerned if the screen is paused for a few minutes.

When the BIOS flashing screen is completed, the system will reboot and will show "Press F1 or F2". At this point, you will need to load the BIOS defaults. Press <F1> to go to the BIOS setup screen, and press <F9> to load the default settings. Next, press <F10> to save and exit. The system will then reboot.



**Attention!** Do not shut down or reset the system while updating the BIOS to prevent possible system boot failure!

**Question:** I think my BIOS is corrupted. How can I recover my BIOS?

**Answer:** Please see Appendix C - BIOS Recovery for detailed instructions.

## 3-4 Battery Removal and Installation

### Battery Removal

To remove the onboard battery, follow the steps below:

1. Power off your system and unplug your power cable.
2. Locate the onboard battery as shown below.
3. Using a tool such as a pen or a small screwdriver, push the battery lock outwards to unlock it. Once unlocked, the battery will pop out from the holder.
4. Remove the battery.

### Proper Battery Disposal

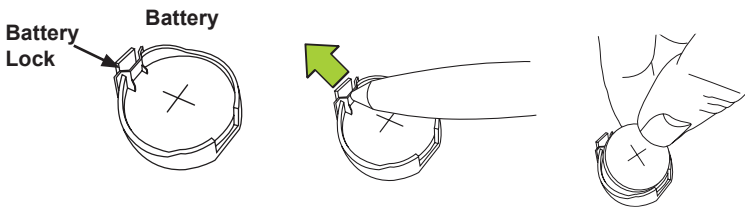

**! Attention!** Please handle used batteries carefully. Do not damage the battery in any way; a damaged battery may release hazardous materials into the environment. Do not discard a used battery in the garbage or a public landfill. Please comply with the regulations set up by your local hazardous waste management agency to dispose of your used battery properly.

## Battery Installation

1. To install an onboard battery, follow the steps 1 and 2 on the previous page and continue below:
2. Identify the battery's polarity. The positive (+) side should be facing up.
3. Insert the battery into the battery holder and push it down until you hear a click to ensure that the battery is securely locked.

**!** **Attention!** When replacing a battery, be sure to only replace it with the same type.

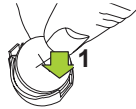
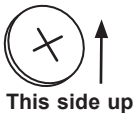

## 3-5 Returning Motherboard for Service

A receipt or copy of your invoice marked with the date of purchase is required before any warranty service will be rendered. You can obtain service by calling your vendor for a Returned Merchandise Authorization (RMA) number. For faster service, you may also obtain RMA authorizations online (<http://www.supermicro.com/RmaForm/>). When you return the motherboard to the manufacturer, the RMA number should be prominently displayed on the outside of the shipping carton, and mailed prepaid or hand-carried. Shipping and handling charges will be applied for all orders that must be mailed when service is complete.

This warranty only covers normal consumer use and does not cover damages incurred in shipping or from failure due to the alteration, misuse, abuse or improper maintenance of products.

During the warranty period, contact your distributor first for any product problems.

## Chapter 4

### BIOS

#### 4-1 Introduction

This chapter describes the AMI BIOS Setup Utility for the C9X299-PGF.



**Note:** BIOS differences between Core™ i9 7980X/7900X, i7 7820X/7800X, i7 7740X, and i5 7640X CPUs will be marked as notes underneath the BIOS feature.

The ROM BIOS is stored in a Flash EEPROM and can be easily updated. This chapter describes the basic navigation of the AMI BIOS Setup Utility setup screens.



**Note:** For AMI BIOS Recovery, please refer to the UEFI BIOS Recovery Instructions in Appendix C.

#### Starting BIOS Setup Utility

To enter the AMI BIOS GUI Setup Utility screens, press the <Delete> key while the system is booting up.



**Note:** In most cases, the <Delete> key is used to invoke the AMI BIOS setup screen.

Each main BIOS menu feature is described in this manual. The Main BIOS setup menu screen has two main frames. The left frame displays all the submenus that can be configured. Grayed-out features cannot be configured. The right frame displays the key legend. Above the key legend is an area reserved for a text message. When a submenu is selected in the left frame, the text becomes blue. Often a text message will accompany it. (**Note:** the AMI BIOS has default text messages built in. Supermicro retains the option to include, omit, or change any of these text messages.)

The AMI BIOS setup utility uses a key-based navigation system called "hot keys". Most of the AMI BIOS setup utility "hot keys" can be used at any time during the setup navigation process. These keys include <F1>, <F4>, <Enter>, <ESC>, arrow keys, etc.



**Note:** Settings in **Bold** are default settings.

## **How To Change the Configuration Data**

The configuration data that determines the system parameters may be changed by entering the AMI BIOS GUI Setup utility. This Setup utility can be accessed by pressing <Del> at the appropriate time during system boot.

### **Changing Between EZ Mode and Advanced Mode**

Above the basic motherboard information and the clock is the EZ Mode/Advanced Mode button. When in EZ Mode, select feature options and an overview of hardware status are displayed (see page 4-3). When in Advanced Mode, all following configuration menus and their contents become available.

## 4-2 EZ Mode



While in EZ Mode, the following information is displayed:

**DRAM Status** - Status of all DIMM slots

**CPU Profile Load** - Allows for quick CPU clocking profile selection

**X.M.P. Profile Load** - Allows for quick memory clocking profile selection

**Fast Boot** - Enables fast booting of the computer

**Boot Order** - Allows changing of the boot order, or click a device to boot selected device

*\*Note: Using this will reboot the computer.*

**HDD List** - Displays which SATA ports are connected to storage devices



**Note:** 'Manual' CPU/X.M.P. profiles are customized in Advanced Mode. Fast Boot is also available in Advanced Mode.

## 4-3 Main



After changing from EZ Mode to Advanced Mode, the Main screen will appear. The Main screen displays the following:

- Type
- ID
- Speed
- L1 Data Cache
- L1 Instruction Cache
- L2 Cache
- L3 Cache
- L4 Cache
- VMX
- SMX/TXT

### CPU Flex Ratio Override

This feature enables CPU Flex Ratio Programming. The options are **Disabled** or **Enabled**.

***\*If enabled, the next feature becomes available to configure.***

### **CPU Flex Ratio Settings**

Enter a value for CPU Flex Ratio settings. The value must be between Max Efficiency Ratio (LFM) and Max non-turbo ratio set by the hardware (HFM). The default is **20**.

### **Hardware Prefetcher**

(Available when supported by the CPU)

If set to Enabled, the hardware prefetcher will prefetch streams of data and instructions from the main memory to the L2 cache to improve CPU performance. The options are Disabled or **Enabled**.

### **Adjacent Cache Line Prefetch**

(Available when supported by the CPU)

Select Enabled for the CPU to prefetch both cache lines for 128 bytes as comprised. Select Disabled for the CPU to prefetch both cache lines for 64 bytes. The options are Disabled or **Enabled**.

### **PECI**

This feature enables Platform Environment Control Interface (PECI), which monitors processor temperature information. The options are Disabled or **Enabled**.

### **Active Processor Cores**

Use this feature to select the number of active processor cores. The options are **All**, 1, 2, 3 and 4. These options depend on how many cores are supported by the CPU.

### **BIST**

Select Enabled to activate the Built-In Self Test (BIST) on reset. The options are Enabled and **Disabled**.

### **AP threads Idle Manner**

Select Enabled to activate AP threads Idle Manner for waiting signal to run. The options are **MWAIT Loop**, Halt Loop and RUN Loop.

### **AP threads Handoff Manner**

Select Enabled to activate AP threads Idle Manner for waiting signal to run. The options are **MWAIT Loop**, and Halt Loop.

### **Machine Check**

Select Enable to activate Machine Check. The options are **Enabled** and Disabled.

### **MonitorMWait**

Select Enable to activate MonitorMWait. The options are **Enabled** and Disabled.

## 4-4 Overclocking



### ► CPU Overclocking

#### All Core OC Setting

This feature controls the CPU overclocking settings. The options are **Manual**, 3.8GHz, 3.9GHz, 4.0GHz, 4.1GHz, 4.2GHz, 4.3GHz, 4.4GHz, 4.5GHz, 4.6GHz, 4.7GHz, 4.8GHz, 4.9GHz, 5.0GHz, 5.1GHz, and 5.2GHz.

#### BCLK Scale Setting

This feature controls the BCLK settings. The options are **100MHz**, 125MHz, 167MHz, and 250MHz.

#### BCLK Frequency (1/1000 MHz)

This feature controls the BCLK frequency. This is automatically controlled by the previous setting.

#### Per Core Mode

When enabled, this feature unlocks 'Core Voltage Mode', 'Core Extra Turbo Voltage', and 'Core Voltage Offset' configuration for Core-0~10. The options are Disabled or **Enabled**.

### **Core-0~10 Max Ratio**

This feature overrides the Core Max Ratio on a per-core basis.

### **Core Max OC Ratio**

This feature controls the general maximum overclocking ratio for the CPU cores and Ring. The default is **0**.

### **AVX2 Negative Offset**

Enter a value for AVX2 Negative Offset. The default is **0**.

### **AVX3 Negative Offset**

Enter a value for AVX3 Negative Offset. The default is **0**.

## **► Processor**

### **TJ-Max offset**

Enter a value to change the TJ-Max value. The default is **0**.

### **OverClocking Feature**

This feature enables processor and memory overclocking features. The options are Disabled or **Enabled**.

### **WDT Enable**

This feature enables the WatchDog Timer (WDT). The options are Disabled or **Enabled**.

### **Hyper-Threading [ALL]**

This feature enables hyper-threading, which is a software method to control logical processor threads. The options are Disabled or **Enabled**.

### **Core Disable Bitmap(Hex)**

Enter a hex value. Value '**0**' enables all cores. Value '3fff' disables all cores.

### **SpeedStep (Pstates)**

This feature enables SpeedStep, also known as System Agent Geyserville. The options are Disabled or **Enabled**.

### **Boot performance mode**

This feature controls the performance state that the BIOS will set initially. The options are **Max Performance** or Max Efficient.

### **Energy Efficient Turbo**

Select Enabled to activate Energy Efficient Turbo. This feature will opportunistically lower the turbo frequency to increase efficiency. We recommend leaving this enabled and disable only in overclocking situations where the turbo frequency must remain constant. The options are **Enabled** or Disabled.

### **Turbo Mode**

When EMTTM is enabled, this feature enables processor Turbo Mode. The options are Disabled or **Enabled**.

### **CPU Flex Ratio Override**

This feature enables CPU Flex Ratio Programming. The options are **Disabled** or Enabled.

### **CPU Flex Ratio**

When the feature above is enabled, this feature allows for a custom ratio value to be entered. It must be between the Max Efficiency Ratio and the Max Non-turbo Ratio set by the hardware. The default is **23**.

### **Thermal Monitor**

This feature enables the thermal monitor. The options are Disabled or **Enabled**.

### **Current Limit Override**

This feature enables current limit override. The options are **Disabled** or Enabled.

### **PL1 Limit**

This feature enables the PL1 limit. If set to disabled, BIOS will program default values for the next two features. The options are **Disabled** or Enabled.

### **PL1 Power Limit**

Enter a value for PL1 Power Limit. The default is **0**.

### **PL1 Time Window**

Enter a value for PL1 Time Window. The default is **1**.

### **PL2 Power Limit**

Enter a value for PL2 Power Limit. The default is **0**.

## PL2 Time Window

Enter a value for PL2 Time Window. The default is **1**.

### ▶ Turbo Ratio Limit

Settings for TurboRatioLimit0~8 and TurboRatioCores0~8 are configurable in this submenu. The default for TurboRatioLimit0 is **40**. The default for TurboRatioCores0 is **10**. The default for the remaining features is **0**.

### ▶ Hardware PM State Control

#### Hardware P-States

This feature controls how P-states are selected. The 'Disable' option bases the choice on OS Request. The '**Native Mode**'/'Native Mode with No Legacy Support' option bases the choice on OS guidance. The 'Out of Band Mode' option enables autonomous P-state selection.

#### HardwarePM Interrupt

This feature enables Hardware PM Interrupt. The options are **Disabled** or Enabled.

#### EPP Enable

This feature enables Enhanced Parallel Port (EPP) for faster data transfer between computer and peripheral devices. The options are Disabled or **Enabled**.

#### APS rocketing

This feature enables APS rocketing, which allows the core ratio to jump to max turbo instantly rather than on a smooth curve. The options are **Disabled** or Enabled.

#### Scalability

This feature enables the use of Scalability in HWP p-code power efficiency algorithms. The options are **Disabled** or Enabled.

#### PPO-Budget

This feature enables PPO-Budget, which allocates power to cores based on their scalability/EPP. The options are **Disabled** or Enabled.

## ▶ CPU C State Control

### Autonomous Core C-State

This feature enables autonomous Core C-State control. The options are **Disabled** or Enabled.

### CPU C6 report

This feature controls CPU C6 reports to the operating system. The options are Disabled, Enabled, and **Auto**.

### Enhanced Halt State(C1E)

This feature enables Enhanced Halt State (takes effect after reboot). The options are Disabled or **Enabled**.

### OS ACPI Cx

This feature controls reporting of CC3/CC6. The options are **ACPI C2** or ACPI C3.

### Package C State

This feature controls the Package C State limit. The options are C0/C1 state, C2 state, C6(non Retention) state, C6(Retention) state, No Limit, and **Auto**.

## ▶ Memory Overclocking

### XMP Profile

This feature controls the XMP profile. The options are **Disabled**, Manual, and Profile 1.

*\*When set to Manual, the following memory timing configurations become available.*

### Memory Frequency

This feature controls the maximum memory frequency (in Mhz). The options are **Auto**, 1000, 1200, 1333, 1400, 1600, 1800, 1866, 2000, 2133, 2200, 2400, 2600, 2666, 2800, 2933, 3000, 3200, 3400, 3466, 3600, 3733, 3800, 4000, 4200, 4266, and 4400.

### Memory Voltage (mV)

Enter a value for Memory Voltage. To select 1.200 volts, enter 1200. The default is **1200**.

**1st memory timing:  
tCL**

This feature configures the Cas Latency Range. Enter a number between 4-18. The default is **15**.

**tRCD**

This feature selects the Row to Col Delay Range. Enter a number between 1-38. The default is **17**.

**tRP**

This feature selects the Ras Precharge Range. Enter a number 1-38. The default is **17**.

**tRAS**

This feature selects the Ras Active Time. Enter a number between 1-586. The default is **36**.

**2nd memory timing:  
Command Timing**

This feature controls the desired memory controller command timing. The options are **1N**, 2N, and 3N.

**tWR**

This feature configures the Minimum Write Recovery Time. Enter a number between 1-38. The default is **16**.

**tRFC**

This feature selects the Minimum Refresh Recovery Delay Time. Enter a number between 1-9363. The default is **374**.

**tRRD**

This feature selects the Minimum Row Active To Row Active Delay Time. Enter a number between 1-38. The default is **4**.

**tRRD\_L**

Enter a value for desired tRRD\_L. The default is **6**.

**tWTR**

This feature configures the Minimum Internal Write to Read Command Delay Time. Enter a number between 1-38. The default is **3**.

**tRTP**

This feature configures the Internal Read to Precharge Command Delay Time. Enter a number between 1-38. The default is **8**.

**tFAW**

This feature selects the Minimum Four Activate Window Delay Time. Enter a numeric value between 1-586. The default is **23**.

**tCWL**

This feature selects the Minimum CAS Write Latency Time. Enter a numeric value. The default is **14**.

**tREFI**

This feature configures the Maximum tREFI Time (Average Periodic Refresh Interval). Enter a numeric value. The default is **8320**.

**tREFIx9**

Enter a value for desired tREFIx9. The default is **73**.

**tRC**

Enter a value for desired tRC. The default is **50**.

**3rd timing:****tWTR\_L**

Enter a value for desired tWTR\_L. The default is **8**.

**tCCD\_L**

Enter a value for desired tCCD\_L. The default is **2**.

**tCCD\_WR\_L**

Enter a value for desired tCCD\_WR\_L. The default is **2**.

**tCKE**

Enter a value for desired tCKE. The default is **6**.

**tXP**

Enter a value for desired tXP. The default is **7**.

**t\_XSDLL**

Enter a value for desired t\_XSDLL. The default is **768**.

**tRRDR**

Enter a value for desired tRRDR. The default is **1**.

**tRRDD**

Enter a value for desired tRRDD. The default is **1**.

**tWWDR**

Enter a value for desired tWWDR. The default is **3**.

**tWWDD**

Enter a value for desired tWWDD. The default is **3**.

**tRWDR**

Enter a value for desired tRWDR. The default is **6**.

**tRWDD**

Enter a value for desired tRWDD. The default is **6**.

**tWRDR**

Enter a value for desired tWRDR. The default is **1**.

**tWRDD**

Enter a value for desired tWRDD. The default is **1**.

**tRWSR**

Enter a value for desired tRWSR. The default is **5**.

**tRRDS**

Enter a value for desired tRRDS. The default is **1**.

**tRWDS**

Enter a value for desired tRWDS. The default is **6**.

**tWWDS**

Enter a value for desired tWWDS. The default is **3**.

**tWRDS**

Enter a value for desired tWRDS. The default is **1**.

**4th memory timing:**

**RTL (CHA DIMM1)**

Enter a value for desired RTL (CHA DIMM1). The default is **0**.

**RTL (CHA DIMM2)**

Enter a value for desired RTL (CHA DIMM2). The default is **0**.

**RTL (CHB DIMM1)**

Enter a value for desired RTL (CHB DIMM1). The default is **0**.

**RTL (CHB DIMM2)**

Enter a value for desired RTL (CHB DIMM2). The default is **0**.

**RTL (CHC DIMM1)**

Enter a value for desired RTL (CHC DIMM1). The default is **0**.

**RTL (CHC DIMM2)**

Enter a value for desired RTL (CHC DIMM2). The default is **0**.

**RTL (CHD DIMM1)**

Enter a value for desired RTL (CHD DIMM1). The default is **69**.

**RTL (CHD DIMM2)**

Enter a value for desired RTL (CHD DIMM2). The default is **0**.

**IOL (CHA DIMM1)**

Enter a value for desired IOL (CHA DIMM1). The default is **0**.

**IOL (CHA DIMM2)**

Enter a value for desired IOL (CHA DIMM2). The default is **0**.

**IOL (CHB DIMM1)**

Enter a value for desired IOL (CHB DIMM1). The default is **0**.

**IOL (CHB DIMM2)**

Enter a value for desired IOL (CHB DIMM2). The default is **0**.

**IOL (CHC DIMM1)**

Enter a value for desired IOL (CHC DIMM1). The default is **0**.

**IOL (CHC DIMM2)**

Enter a value for desired IOL (CHC DIMM2). The default is **0**.

**IOL (CHD DIMM1)**

Enter a value for desired IOL (CHD DIMM1). The default is **4**.

### **IOL (CHD DIMM2)**

Enter a value for desired IOL (CHD DIMM2). The default is **0**.

### **RcompTarget[RdOdt]**

Enter a value for desired Rcomptarget[RdOdt]. The default is **60**.

### **RcompTarget[WrdS]**

Enter a value for desired RcompTarget[WrdS]. The default is **26**.

### **RcompTarget[WrdSCmd]**

Enter a value for desired RcompTarget[WrdSCmd]. The default is **20**.

### **RcompTarget[WrdSctl]**

Enter a value for desired RcompTarget[WrdSctl]. The default is **20**.

### **RcompTarget[WrdSclk]**

Enter a value for desired RcompTarget[WrdSclk]. The default is **26**.

### **Rcompresistors1**

Enter a value for desired Rcompresistors1. The default is **121**.

### **Rcompresistors2**

Enter a value for desired Rcompresistors2. The default is **75**.

### **Rcompresistors3**

Enter a value for desired Rcompresistors3. The default is **100**.

## **► DDR4 ODT Configuration**

### **CHA DIMM1 RTT\_WR**

Enter a value for desired CHA DIMM1 RTT\_WR. The options are **Auto**, Disabled, 60, 80, 120, 240, and Infinity.

### **CHA DIMM1 RTT\_Prk**

Enter a value for desired CHA DIMM1 RTT\_Prk. The options are **Auto**, Disabled, 60, 80, 120, 240, and Infinity.

### **CHA DIMM1 RTT\_NOM**

Enter a value for desired CHA DIMM1 RTT\_NOM. The options are **Auto**, Disabled, 60, 80, 120, 240, and Infinity.

**CHA DIMM2 RTT\_WR**

Enter a value for desired CHA DIMM2 RTT\_WR. The options are **Auto**, Disabled, 60, 80, 120, 240, and Infinity.

**CHA DIMM2 RTT\_Prk**

Enter a value for desired CHA DIMM2 RTT\_Prk. The options are **Auto**, Disabled, 60, 80, 120, 240, and Infinity.

**CHA DIMM2 RTT\_NOM**

Enter a value for desired CHA DIMM2 RTT\_NOM. The options are **Auto**, Disabled, 60, 80, 120, 240, and Infinity.

**CHB DIMM1 RTT\_WR**

Enter a value for desired CHB DIMM1 RTT\_WR. The options are **Auto**, Disabled, 60, 80, 120, 240, and Infinity.

**CHB DIMM1 RTT\_Prk**

Enter a value for desired CHB DIMM1 RTT\_Prk. The options are **Auto**, Disabled, 60, 80, 120, 240, and Infinity.

**CHB DIMM1 RTT\_NOM**

Enter a value for desired CHB DIMM1 RTT\_NOM. The options are **Auto**, Disabled, 60, 80, 120, 240, and Infinity.

**CHB DIMM2 RTT\_WR**

Enter a value for desired CHB DIMM2 RTT\_WR. The options are **Auto**, Disabled, 60, 80, 120, 240, and Infinity.

**CHB DIMM2 RTT\_Prk**

Enter a value for desired CHB DIMM2 RTT\_Prk. The options are **Auto**, Disabled, 60, 80, 120, 240, and Infinity.

**CHB DIMM2 RTT\_NOM**

Enter a value for desired CHB DIMM2 RTT\_NOM. The options are **Auto**, Disabled, 60, 80, 120, 240, and Infinity.

**CHC DIMM1 RTT\_WR**

Enter a value for desired CHC DIMM1 RTT\_WR. The options are **Auto**, Disabled, 60, 80, 120, 240, and Infinity.

**CHC DIMM1 RTT\_Prk**

Enter a value for desired CHC DIMM1 RTT\_Prk. The options are **Auto**, Disabled, 60, 80, 120, 240, and Infinity.

---

### **CHC DIMM1 RTT\_NOM**

Enter a value for desired CHC DIMM1 RTT\_NOM. The options are **Auto**, Disabled, 60, 80, 120, 240, and Infinity.

### **CHC DIMM2 RTT\_WR**

Enter a value for desired CHC DIMM2 RTT\_WR. The options are **Auto**, Disabled, 60, 80, 120, 240, and Infinity.

### **CHC DIMM2 RTT\_Prk**

Enter a value for desired CHC DIMM2 RTT\_Prk. The options are **Auto**, Disabled, 60, 80, 120, 240, and Infinity.

### **CHC DIMM2 RTT\_NOM**

Enter a value for desired CHC DIMM2 RTT\_NOM. The options are **Auto**, Disabled, 60, 80, 120, 240, and Infinity.

### **CHD DIMM1 RTT\_WR**

Enter a value for desired CHD DIMM1 RTT\_WR. The options are **Auto**, Disabled, 60, 80, 120, 240, and Infinity.

### **CHD DIMM1 RTT\_Prk**

Enter a value for desired CHD DIMM1 RTT\_Prk. The options are **Auto**, Disabled, 60, 80, 120, 240, and Infinity.

### **CHD DIMM1 RTT\_NOM**

Enter a value for desired CHD DIMM1 RTT\_NOM. The options are **Auto**, Disabled, 60, 80, 120, 240, and Infinity.

### **CHD DIMM2 RTT\_WR**

Enter a value for desired CHD DIMM2 RTT\_WR. The options are **Auto**, Disabled, 60, 80, 120, 240, and Infinity.

### **CHD DIMM2 RTT\_Prk**

Enter a value for desired CHD DIMM2 RTT\_Prk. The options are **Auto**, Disabled, 60, 80, 120, 240, and Infinity.

### **CHD DIMM2 RTT\_NOM**

Enter a value for desired CHD DIMM2 RTT\_NOM. The options are **Auto**, Disabled, 60, 80, 120, 240, and Infinity.

## Enforce POR

This feature enables Plan Of Record restrictions for DDR4 frequency and voltage programming. The options are Auto, POR, and **Disabled**.

## ▶ Voltage Configuration



**Note:** This submenu only displays when using Core™ i7 7740X or i5 7640X CPUs.

### Core Voltage Mode

This feature controls the Core Voltage Mode. Adaptive Mode only allows for voltage interpolation in turbo mode. Override Mode forces the selected voltage to be applied over all operating frequencies. The default is **Adaptive**.

### Core Extra Turbo Voltage (mV)

This feature controls the extra turbo voltage that is applied while the IA Core is operating in turbo mode. The range is 0~2000 mV. The default is **0**.

### Core Voltage Offset

This feature controls the offset voltage applied to the IA Core domain. The range is negative 500 to positive 500 mV.

### Offset Prefix

Use this feature to set the prefix value as a positive (+) or a negative (-). The options are "+" and "-".

### Adjust PII

Use this feature to adjust the PLL for Higher-BCLK ratio combination. The options are **Disabled** or Enabled.

### Change PIITrim Value

Enter a value for PIITrim. The range is negative 63 to positive 63.

### Change PLLTRIM Prefix

Use this feature to set the PLLTRIM prefix value as a positive (+) or a negative (-). The options are "+" and "-".

### Change MC-PIITrim Value

Enter a value for MC-PIITrim. The range is negative 63 to positive 63.

## Change MC-PLLTRIM Prefix

Use this feature to set the MC-PLLTRIM prefix value as a positive (+) or a negative (-). The options are "+" and "-".

### ► CLR/Ring

#### **CLR Max OC Ratio**

Enter a value for the maximum overclocking ratio of the CLR domain. The default is **0**.

#### **CLR Min Ratio**

Enter a value for the minimum overclocking ratio of the CLR domain. The default is **8**.

#### **CLR Voltage Mode**

This feature controls the CLR Voltage Mode. Adaptive Mode only allows for voltage interpolation in turbo mode. Override Mode forces the selected voltage to be applied over all operating frequencies. The default is **Adaptive**.

#### **CLR Extra Turbo Voltage (mV)**

This feature controls the extra turbo voltage applied while GT is operating in turbo mode. The range is 0~2000 mV.

#### **CLR Voltage Offset (mV)**

This feature controls the offset voltage applied to the GT domain. The range is negative 100 to positive 1000 mV.

#### **Offset Prefix**

Use this feature to set the prefix value as a positive (+) or a negative (-). The options are "+" and "-".

### ► Uncore

#### **Uncore Voltage Offset**

Enter a value for the Uncore voltage offset (in millivolts). The value range is negative 1000 to positive 1000. The default is **0**.

#### **Offset Prefix**

This feature controls whether the offset value prefix. The options are positive (**+**) or negative (**-**).

---

## ► SVID/FIVR

### SVID Support

This feature enables SVID, which allows input voltage overrides. The options are Disabled or **Enabled**.

### SVID Voltage Override (mV)

Enter a value for the Vccin input voltage. The range is 0~2500 mV. The default is **0**.

### SVID VCCSA Voltage (mV)

Enter a value for the VccSA input voltage. The range is 0~2500 mV. The default is **0**.

### SVID VCCIO Voltage (mV)

Enter a value for the VccIO input voltage. The range is 0~2500 mV. The default is **0**.

### Load Line Calibration

Load line calibration is vDroop, which is the tendency for a CPU's vCore to drop when going from an idle state to a load state. Enable this feature to reduce vDroop. The options are Disabled, Level 1~Level 7, and **Auto**.

### Vcc PCH Vout voltage override enable

This feature enables Vcc PCH Vout voltage rail override by using SMBUS/PMBUS interface of VRM. The options are **Disabled** or Enabled.

*\*If this feature is enabled, the next feature becomes available to configure.*

### Vcc PCH Vout voltage

This feature controls the Vcc PCH Vout voltage. The options are **1.000V**, 1.106V, 1.194V, 1.288V, and 1.385V.

### FIVR Faults

This feature enables FIVR Faults. When this feature is disabled, OVP and OCP protection mechanisms will be masked. The options are Disabled or **Enabled**.

***\*It is NOT recommended to select Disabled. Selecting Disabled may have negative consequences.***

### **FIVR Efficiency Management**

This feature enables FIVR Efficiency Management, which is useful for power delivery efficiency, but it might create issues with proper power delivery control while overclocking, especially BCLK overclocking. The options are Disabled or **Enabled**.

## 4-5 CPU



**Note:** The following submenus only display when using Core™ i9 7980X/7900X or i7 7900X/7820X/7800X CPUs. Core™ i7 7740X and i5 7640X CPUs display different options.

### ► Processor Configuration

Information (dependent on current hardware) is shown for the following features:

**Processor BSP Revision**

**Processor ID**

**Processor Frequency**

**Processor Max Ratio**

**Processor Min Ratio**

**Microcode Revision**

**L1 Cache RAM**

**L2 Cache RAM**

**L3 Cache RAM**

**Processor 0 Version**

### **Hyper-Threading [ALL]**

This feature enables hyper-threading. The options are Disabled or **Enabled**.

### **Max CPUID Value Limit**

This feature enables legacy operating systems which cannot support CPUs with extended CPUID to boot. The options are **Disabled** or Enabled.

### **Execute Disable Bit**

This feature enables Execute Disable Bit. When disabled, it forces the Execute Disable feature flag to always return 0. The options are Disabled or **Enabled**.

### **Intel(VMX) Virtualization Technology**

This feature enables a VMM to utilize Vanderpool (virtualization) Technology hardware capabilities. The options are Disabled or **Enabled**.

### **PPIN Control**

This feature unlocks and either enables or disables PPIN Control. The options are Unlock/Disable or **Unlock/Enable**.

### **Hardware Prefetcher**

This feature controls the MLC streamer prefetcher. The options are Disabled or **Enabled**.

### **Adjacent Cache Prefetch**

This feature enables Adjacent Cache Prefetch. The options are Disabled or **Enabled**.

### **DCU Streamer Prefetcher**

This feature enables DCU Streamer Prefetcher, which is an L1 data cache prefetcher. The options are Disabled or **Enabled**.

### **DCU IP Prefetcher**

This feature enables DCU IP Prefetcher, which is an L1 data cache prefetcher. The options are Disabled or **Enabled**.

### **LLC Prefetch**

This feature enables LLC Prefetch. The options are **Disabled** or Enabled.

### **DCU Mode**

This mode controls which Data Cache Unit (DCU) mode is enabled. The options are **32KB 8Way Without ECC** or 16KB 4Way With ECC.

### **Extended APIC**

This feature enables extended APIC support. The options are **Disabled** or Enabled.

---

## AES-NI

This feature enables AES-NI support. The options are Disabled or **Enabled**.

## APIC Physical Mode

This feature enables APIC Physical Destination Mode. The options are **Disabled** or Enabled.

# ▶ Advanced Power Management Configuration

## ▶ CPU P State Control

### SpeedStep (Pstates)

This feature enables SpeedStep, also known as System Agent Geyserville. The options are Disabled or **Enabled**.

### EIST PSD Function

This feature controls the EIST PSD Function. The options are **HW\_ALL**, SW\_ALL, and SW\_ANY.

### Turbo Mode

When EMTTM is enabled, this feature enables processor Turbo Mode. The options are Disabled or **Enabled**.

## ▶ Hardware PM State Control

### Hardware P-States

This feature controls how P-states are selected. The '**Disable**' option bases the choice on OS Request. The 'Native Mode'/'Native Mode with No Legacy Support' option bases the choice on OS guidance. The 'Out of Band Mode' option enables autonomous P-state selection.

## ▶ CPU C State Control

### Autonomous Core C-State

This feature enables Autonomous Core C-State support. The options are **Disabled** or Enabled.

### **CPU C6 report**

This feature enables CPU C6(ACPI C3) reporting to the operating system. The options are Disabled, Enabled, and **Auto**.

### **Enhanced Halt State (C1E)**

This feature enables Enhanced Halt State (takes effect after reboot). The options are Disabled or **Enabled**.

## ▶ **Package C State Control**

### **Package C State**

This feature controls the Package C State limit. The options are C0/C1 state, C2 state, C6(non Retention) state, C6(Retention) state, No Limit, and **Auto**.

## ▶ **Common RefCode Configuration**

### **MMCFG Size**

This feature controls the MMCFG Size. The options are 64M, 128M, **256M**, 512M, 1G, and 2G.

### **MMIOHBase**

This feature controls the MMIO High Base. The options are **56T**, 40T, 24T, 16T, 4T, and 1T.

### **MMIO High Granularity Size**

This feature controls the allocation size used to assign MMIOH resources. The options are 1G, 4G, 16G, 64G, 256G, and **1024G**.

## ▶ **Advanced Power Management Configuration**

### ▶ **CPU P State Control**

#### **SpeedStep (Pstates)**

This feature enables SpeedStep, also known as System Agent Geyserville. The options are Disabled or **Enabled**.

#### **EIST PSD Function**

This feature controls the EIST PSD Function. The options are **HW\_ALL**, SW\_ALL, and SW\_ANY.

## **Turbo Mode**

When EMTTM is enabled, this feature enables processor Turbo Mode. The options are Disabled or **Enabled**.

## ▶ **Hardware PM State Control**

### **Hardware P-States**

This feature controls how P-states are selected. The '**Disable**' option bases the choice on OS Request. The 'Native Mode'/'Native Mode with No Legacy Support' option bases the choice on OS guidance. The 'Out of Band Mode' option enables autonomous P-state selection.

## ▶ **CPU C State Control**

### **Autonomous Core C-State**

This feature enables Autonomous Core C-State support. The options are **Disabled** or Enabled.

### **CPU C6 report**

This feature enables CPU C6(ACPI C3) reporting to the operating system. The options are Disabled, Enabled, and **Auto**.

### **Enhanced Halt State (C1E)**

This feature enables Enhanced Halt State (takes effect after reboot). The options are Disabled or **Enabled**.

## ▶ **Package C State Control**

### **Package C State**

This feature controls the Package C State limit. The options are C0/C1 state, C2 state, C6(non Retention) state, C6(Retention) state, No Limit, and **Auto**.

## 4-6 Memory



**Note:** The following submenus only display when using Core™ i9 7980X/7900X or i7 7900X/7820X/7800X CPUs. Core™ i7 7740X and i5 7640X CPUs display different options.

### Enforce POR

When enabled, this feature enforces Plan of Record restrictions for DDR4 frequency and voltage programming. The options are **Auto**, **POR**, and **Disabled**.

### Memory Frequency

This feature controls the maximum memory frequency (in MHz). The options are **Auto**, 1000, 1200, 1333, 1400, 1600, 1800, 1866, 2000, 2133, 2000, 2400, 2600, and 2666.

### Custom Refresh Enable

This feature enables a custom memory refresh rate. The options are **Disabled** or **Enabled**.

### MC BGF threshold

Enter a value for the HA to MC BGF threshold, which is used for scheduling MC request in bypass conditions. The default is **0**.

### DLL Reset Test

Enter a value for the amount of loops to execute RMT for during DLL reset tests. The default is **0**.

## ► Memory Topology

The currently installed memory topology is displayed here.

## ► Memory RAS Configuration

### Static Virtual Lockstep Mode

This feature enables Static Virtual Lockstep mode. The options are **Disabled** or Enabled.

### Mirror mode

This feature enables Mirror mode, which is useful when memory redundancy is important. The options are **Disabled**, Mirror Mode 1LM, and Mirror Mode 2LM.

*\*Enabling Mirror mode will reduce memory capacity by half.*

### ADDDC Sparing

This feature enables Adaptive Double Device Data Correction (ADDDC) Sparing, which detects when the predetermined threshold for correctable errors is reached and copies the contents of the failing DIMM to spare memory. The options are **Disabled** or Enabled.

### Patrol Scrub

This feature enables Patrol Scrubbing, which is a process that allows the CPU to correct correctable memory errors detected on a memory module and send the correction to the requestor (the original source). When this feature is enabled, the IO hub will read and write back one cache line every 16K cycles if there is no delay caused by internal processing. By using this method, roughly 64 GB of memory behind the IO hub will be scrubbed every day. The options are **Disabled** or **Enabled**.

### **Patrol Scrub Interval**

This feature controls how many hours the system should wait before the next complete patrol scrub is performed. Enter a value from 0-24. The default setting is **24**.

### **Patrol Scrub Address Mode**

This feature controls which address mode Patrol Scrub uses. The options are Reverse Address or **System Physical Address**.

## 4-7 Advanced



**Note:** The following submenus only display when using Core™ i9 7980X/7900X or i7 7900X/7820X/7800X CPUs. Core™ i7 7740X and i5 7640X CPUs display different options.

### ► PCH-FW Configuration

This menu shows the following information:

- **ME Firmware Version**
- **ME Firmware Mode**
- **ME Firmware SKU**
- **ME File System Integrity Value**
- **ME Firmware Status 1**
- **ME Firmware Status 2**

## Me FW Image Re-Flash

Use this feature to update the Management Engine firmware from an image in a USB flash drive attached to a USB port. The options are **Disabled** or **Enabled**.

## ► Chipset Configuration



**Note:** Setting incorrect values in the following two submenus may cause **system malfunction**.

## ► North Bridge

### ► IIO Configuration

#### EV DFX Features

This feature enables IIO DFX devices and other CPU devices like PMON. The options are **Disabled** or **Enabled**.

#### Isoc Mode

This feature controls Isoc mode support. The options are **Disabled**, **Enabled**, and **Auto**.

## ► CPU Configuration

### IOU0 (IIO PCIe Br1)

This feature controls the port bifurcation for the selected slot(s). The options are [x4x4x4x4], [x4x4x8], [x8x4x4], [x8x8], [x16], and **Auto**.

### IOU1 (IIO PCIe Br2)

This feature controls the port bifurcation for the selected slot(s). The options are [x4x4x4x4], [x4x4x8], [x8x4x4], [x8x8], [x16], and **Auto**.

### IOU2 (IIO PCIe Br3)

This feature controls the port bifurcation for the selected slot(s). The options are [x4x4x4x4], [x4x4x8], [x8x4x4], [x8x8], [x16], and **Auto**.

### ▶ CPU SLOT6 PCI-E 3.0 x 16

#### Link Speed

This feature controls the link speed for this PCIe port. The options are **Auto**, Gen 1 (2.5 GT/s), Gen 2 (5GT/s), and Gen 3 (8 GT/s).

#### PCI-E Port Max Payload Size

This feature controls this PCIe port's maximum payload size. If possible set to 256B. The default is **Auto**.

### ▶ CPU SLOT4 PCI-E 3.0 x 8

#### Link Speed

This feature controls the link speed for this PCIe port. The options are **Auto**, Gen 1 (2.5 GT/s), Gen 2 (5GT/s), and Gen 3 (8 GT/s).

#### PCI-E Port Max Payload Size

This feature controls this PCIe port's maximum payload size. If possible set to 256B. The default is **Auto**.

### ▶ JNVME0~2

#### Link Speed

This feature controls the link speed for this PCIe port. The options are **Auto**, Gen 1 (2.5 GT/s), Gen 2 (5GT/s), and Gen 3 (8 GT/s).

#### PCI-E Port Max Payload Size

This feature controls this PCIe port's maximum payload size. If possible set to 256B. The default is **Auto**.

### ▶ IOAT Configuration

#### Disable TPH

This feature disables TLP Processing Hints (TPH). The options are **No** (enabled) or Yes (disabled).

#### Prioritize TPH

This feature prioritizes TLP Processing Hints (TPH). The options are **Disabled** or Enabled.

### **Relaxed Ordering**

This feature enables Relaxed Ordering. The options are Enabled or **Disabled**.

#### ▶ **Intel® VT for Directed I/O (VT-d)**

##### **Intel® VT for Directed I/O (VT-d)**

This feature enables VT-d by reporting the I/O device assignment to VMM. The options are Disabled or **Enabled**.

### **Interrupt Remapping**

This feature enables VT-d Interrupt Remapping support. The options are Disabled or **Enabled**.

### **PassThrough DMA**

This feature enables Non-Isoch VT-d engine PassThrough DMA support. The options are Disabled or **Enabled**.

### **ATS**

This feature enables Non-Isoch VT-d engine ATS support. The options are Disabled or **Enabled**.

### **Posted Interrupt**

This feature enables VT-d posted interrupt. The options are Disabled or **Enabled**.

### **Coherency Support (Non-Isoch)**

This feature enables Non-Isoch VT-d engine Coherency support. The options are Disabled or **Enabled**.

#### ▶ **Intel® VMD technology**

##### ▶ **Intel® VMD for Volume Management Device on CPU**

##### **Intel® VMD for Volume Management**

This feature enables Volume Management Device technology in this stack. The options are **Disabled** or Enabled.

---

## PCI-E Completion Timeout Disable

This feature disables PCIe completion timeout. The options are **No**, Yes, and Per-Port.

### ► South Bridge

#### USB Module Version

**USB Devices** - These settings will differ based on currently plugged in devices.

#### Legacy USB Support

This feature enables legacy USB support. The Auto setting disables legacy support when no USB device is connected. The options are Disabled, **Enabled**, and Auto.

#### XHCI Hand-off

This feature enables a workaround for operating systems without XHCI hand-off support. The options are Disabled or **Enabled**.

#### Port 60/64 Emulation

This feature enables port 60/64h emulation support, which is used to complete USB keyboard legacy support. The options are Disabled or **Enabled**.

#### RSA Support

This feature enables Rack Scale Architecture (RSA) support. The options are **Disabled** or Enabled.

#### Azalia

This feature enables HD Audio (Azalia) devices. The options are **Auto** or Disabled.

### ► SATA And RST Configuration

#### SATA Controllers

Use this feature to enable or disable the onboard SATA Controllers. The options are **Enabled** or Disabled.

#### Configure SATA as

Use this feature to select the mode for the installed SATA drives. The options are **AHCI** or RAID.

### **Aggressive Link Power Management**

Select enabled for the PCH to aggressively enter the link power state. The options are Disabled or **Enabled**.

### **Storage Option ROM/UEFI Driver**

This feature controls the execution of UEFI and Legacy OpROM. The options are Disabled, UEFI, and **Legacy**.

### **Serial ATA Port 0~7**

#### **Software Preserve**

This feature displays the software information for the detected device.

#### **Hot Plug**

This feature designates the port specified for hot plugging. Set to Enabled for hot-plugging support, which will allow the user to replace a SATA disk drive without shutting down the system. The options are Enabled or **Disabled**.

#### **Spin Up Device**

When this feature is disabled, all drives will spin up at boot. When it is enabled, it will perform Staggered Spin Up on any drive this feature is activated. The options are Enabled or **Disabled**.

#### **SATA Device Type**

Use this feature to identify the type of HDD that is connected to the STATA port. The options are **Hard Disk Drive** or Solid State Drive.

### **▶ Trusted Computing**

- **TPM20 Device Found\***
- **Vendor:** IFX\*
- **Firmware Version:** 5.51\*

*\*Exact hardware details will depend on currently installed hardware.*

## Security Device Support

If this feature and the TPM jumper on the motherboard are both set to Enabled, onboard security devices will be enabled for TPM (Trusted Platform Module) support to enhance data integrity and network security. Please reboot the system for a change on this setting to take effect. The options are Disabled or **Enabled**.

The following Platform Configuration Register information will be displayed:

- Active PCR banks: SHA-1,SHA256
- Available PCR banks: SHA-1,SHA256

*\*If the feature 'Security Device Support' is set to Enable, the following features will become available for configuration:*

### SHA-1 PCR Bank

Use this feature to disable or enable the SHA-1 Platform Configuration Register (PCR) bank for the installed TPM device. The options are Disabled or **Enabled**.

### SHA256 PCR Bank

Use this feature to disable or enable the SHA256 Platform Configuration Register (PCR) bank for the installed TPM device. The options are Disabled or **Enabled**.

### Pending Operation

Use this feature to schedule a TPM-related operation to be performed by a security device for system data integrity. Your system will reboot to carry out a pending TPM operation. The options are **None** or TPM Clear.

### Platform Hierarchy

Use this feature to disable or enable platform hierarchy for platform protection. The options are Disabled or **Enabled**.

### Storage Hierarchy

Use this feature to disable or enable storage hierarchy for cryptographic protection. The options are Disabled or **Enabled**.

### Endorsement Hierarchy

Use this feature to disable or enable endorsement hierarchy for privacy control. The options are Disabled or **Enabled**.

## PH Randomization

This feature enables Platform Hierarchy randomization. The options are **Disabled** or **Enabled**.

***\*This feature is ONLY for development testing purposes.***

## ▶ ACPI Settings

### WHEA Support

Enable this feature to support the Windows Hardware Error Architecture (WHEA) platform and provide a common infrastructure for the system to handle hardware errors within the Windows OS environment in order to reduce system crashes and enhance system recovery and health monitoring. The options are **Disabled** or **Enabled**.

### High Precision Event Timer

Enable this feature to activate the High Precision Event Timer (HPET), which produces periodic interrupts at a much higher frequency than a Real-time Clock (RTC) does in synchronizing multimedia streams, providing smooth playback and reducing the dependency on other timestamp calculation devices, such as an x86 RDTSC Instruction embedded in the CPU. The High Precision Event Timer is used to replace the 8254 Programmable Interval Timer. The options are **Disabled** or **Enabled**.

### Native PCIE Enable

This feature enables Native PCIE control. The options are **Disabled** or **Enabled**.

### Native ASPM

This feature selects what controls ASPM. The options are **Disabled** (BIOS controlled), **Enabled** (operating system controlled), and **Auto**.

## ▶ Boot Feature

### Boot Feature

#### Fast Boot

Enable this feature to reduce the time the computer takes to boot up. The computer will boot with a minimal set of required devices. This feature does not have an effect on BBS boot options in the Boot tab. The options are **Disabled** and **Enabled**.

### Quiet Boot

Use this feature to select the screen display between POST messages or the OEM logo at bootup. Select Disabled to display the POST messages. Select Enabled to display the OEM logo instead of the normal POST messages. The options are Unchecked or **Checked**.

### Bootup Num-Lock

Use this feature to set the Power-on state for the Numlock key. The options are Off or **On**.

### Option ROM Messages

This feature controls the display mode for Option ROM. The options are **Force BIOS** or Keep Current.

### INT19 (Interrupt 19) Trap Response

Interrupt 19 is the software interrupt that handles the boot disk function. When this feature is set to Immediate, the ROM BIOS of the host adaptors will "capture" Interrupt 19 at bootup immediately and allow the drives that are attached to these host adaptors to function as bootable disks. If this feature is set to Postponed, the ROM BIOS of the host adaptors will not capture Interrupt 19 immediately and allow the drives attached to these adaptors to function as bootable devices at boot. The options are **Immediate** or Postponed.

### Port 61h Bit-4 Emulation

This feature enables port 61h bit-4 toggling in SMM. The options are **Disabled** or Enabled.

### Wait for "F1" If Error

This feature forces the system to wait until the F1 key is pressed if an error occurs. The options are Disabled or **Enabled**.

### Re-try Boot

When EFI Boot is selected, the BIOS will automatically reboot the system from an EFI boot device after its initial boot failure. Select Legacy Boot to allow the BIOS to automatically reboot the system from a Legacy boot device after its initial boot failure. The options are **Disabled**, Legacy Boot, and EFI Boot.

### Watch Dog Function

If enabled, the Watch Dog timer will allow the system to reboot when it is unresponsive for more than five minutes. The options are **Disabled** or Enabled.

### Power Button Function

This feature controls how the system shuts down when the power button is pressed. Select 4 Seconds Override for the user to power off the system after pressing and holding the power button for four seconds or longer. Select Instant Off to instantly power off the system as soon as the user presses the power button. The options are **Instant Off** or 4 Seconds Override.

### AC Loss Policy Depend on

Use this feature to set the power state after a power outage. Select "Power Off" for the system power to remain off after a power loss. Select "Power On" for the system power to be turned on after a power loss. Select 'Last State' to allow the system to resume its last power state before a power loss. The options are Stay Off, Power On, and **Last State**.

### EuP Support

EuP, or Energy Using Product, is a European energy-saving specification that sets a standard on the maximum total power consumption on electrical products. The options are **Unchecked** or Checked.

### Setup Mode

This feature sets the default screen when entering BIOS setup. The options are **EZ Mode** or Advanced Mode.

## ► NCT6792D Super IO Configuration

### NCT6792D Super IO Configuration

#### Super IO Chip - NCT6792D

### ► Serial Port 1 Configuration

#### Serial Port 1

This feature enables the Serial Port 1 (COM1). The options are **Unchecked** or Checked.

---

**Current Limit Override** - The current limit override is shown.

### Change Settings

This feature controls the Super IO device settings. The options are **Auto**, [IO=3F8h; IRQ=4;], [IO=3F8h; IRQ=3,4,5,6,7,9,10,11,12;], [IO=2F8h; IRQ=3,4,5,6,7,9,10,11,12;], [IO=3E8h; IRQ=3,4,5,6,7,9,10,11,12;], and [IO=2E8h; IRQ=3,4,5,6,7,9,10,11,12;].

## ▶ AST2500SEC Super IO Configuration

### AST2500SEC Super IO Configuration

**Super IO Chip** - AST2500SEC

## ▶ Serial Port 2 Configuration

### Serial Port

This feature enables the Serial Port (COM). The options are Unchecked or **Checked**.

**Current Limit Override** - The current limit override is shown.

### Change Settings

This feature controls the Super IO device settings. The options are **Auto**, [IO=2E8h; IRQ=7;], [IO=3F8h; IRQ=3,4,5,6,7,9,10,11,12;], [IO=2F8h; IRQ=3,4,5,6,7,9,10,11,12;], [IO=3E8h; IRQ=3,4,5,6,7,9,10,11,12;], and [IO=2E8h; IRQ=3,4,5,6,7,9,10,11,12;].

## ▶ Serial Port Console Redirection

### COM1

#### Console Redirection

This feature enables Console Redirection for remote data exchange. The options are **Unchecked** or Checked.

*\*The submenu below controls the specifics of how data is exchanged between the host and remote computer.*

## ► Console Redirection Settings

### Terminal Type

This feature controls the terminal emulation type. The options are **VT100**, VT100+, VT-UTF8, and ANSI.

### Bits per second

This feature controls the transmission speed of the host serial port, which must be matched by the remote serial port. The options are 9600, 19200, 38400, 57600, and **115200**.

### Data Bits

This feature controls the data bits. The options are 7 or **8**.

### Parity

This feature controls whether parity bits are sent with data bits in order to detect transmission errors. The options are **None**, Even, Odd, Mark, and Space.

### Stop Bits

This feature controls the amount of stop bits to send at the end of a data packet. Slow devices may require more than one stop bit. The options are **1** or 2.

### Flow Control

This feature can prevent data loss from buffer overflow. The options are **None** or Hardware RTS/CTS.

### VT-UTF8 Combo Key Support

This feature enables VT-UTF8 Combo Key support for ANSI/VT100 terminals. The options are Unchecked or **Checked**.

### Recorder Mode

This feature enables only text to be sent across consoles. The options are **Unchecked** or Checked.

### Resolution 100x31

This feature enables extended terminal resolution. The options are Unchecked or **Checked**.

### Legacy OS Redirection Resolution

This feature controls the number of rows and columns supported by redirection on legacy operating systems. The options are **80x24** or 80x25

### Putty KeyPad

This feature controls Putty KeyPad support. The options are **VT100**, LINUX, XTERMR6, SCO, ESCN, and VT400.

### Redirection After BIOS POST

This feature controls when redirection is enabled. The "BootLoader" option disables redirection until after booting to legacy operating system. The options are **Always Enable** or BootLoader.

## SOL (Disabled)

**Console Redirection - Port Is Disabled**

### Legacy Console Redirection

#### Legacy Serial Redirection Port

This feature controls which COM port to display redirection of legacy operating systems and OPROM messages. The options are **COM1** or 'SOL (Disabled)'.  
*\*The submenu below controls the specifics of how data is exchanged between the host and remote computer.*

### Serial Port for Out-of-Band Management/Windows Emergency Management Services (EMS)

#### Console Redirection

This feature enables console redirection for EMS. The options are **Unchecked** or Checked.

*\*The submenu below controls the specifics of how data is exchanged between the host and remote computer.*

## ► Console Redirection Settings

### Out-of-Band Mgmt Port

This feature controls which port will be used for Out-of-Band (Windows Server) Management. The options are **COM1** or SOL (Disabled).

### Terminal Type

This feature controls which terminal type is used for Out-of-Band Management. The preferred type is VT-UTF8, then VT100+, then VT100. The options are VT100, VT100+, **VT-UTF8**, and ANSI.

### Bits per second

This feature controls the transmission speed of the host serial port, which must be matched by the remote serial port. The options are 9600, 19200, 57600, and **115200**.

### Flow Control

This feature can prevent data loss from buffer overflow. The options are **None**, Hardware RTS/CTS, and Software Xon/Xoff.

### Data Bits - 8

### Parity - None

### Stop Bits - 1

## ► PCIe/PCI/PnP Configuration

### Option ROM execution

#### Video

This feature controls which option ROM to execute for the Video device. The options are Do Not Launch, UEFI, and **Legacy**.

#### Above 4G Decoding

This feature enables remapping of BIOS above 4GB. The options are Enabled or **Disabled**.

#### Onboard Video Option ROM

This feature controls which onboard video firmware will be loaded. The options are Legacy or **UEFI**.

#### VGA Priority

This feature controls the VGA output priority. The options are **Onboard VGA**, CPU SLOT1 PCI-E 3.0X8, PCH SLOT2 PCI-E 3.0 X1, CPU SLOT3 PCI-E 3.0 X8, CPU SLOT5 PCI-E 3.0 X8, CPU SLOT7 PCI-E 3.0 X16.

**PCI-E Slot 1, 2, 3, 5, 7 OPROM**

This feature enables PCI/PCIX/PCIe OPROM option for the corresponding slot number. The options are Disabled, **Legacy**, and UEFI.

**CPU SLOT1/U.2\_1 Select (only 44-lane CPUs)**

This feature selects between CPU SLOT1 or U.2\_1 PCIe support. The options are **CPU SLOT1** or U.2 CONECTOR 1.

**CPU SLOT3/U.2\_2 Select (only 28-lane CPUs)**

This feature selects between CPU SLOT3 or U.2\_3 PCIe support. The options are **CPU SLOT3** or U.2 CONECTOR 2.

**CPU SLOT3/SLOT5 Select**

This feature selects between a combination of SLOT3/SLOT5 configuration or only SLOT5. The options are [**CPU SLOT3 X8 SLOT5 X8**] or [CPU SLOT5 X16].

**Onboard LAN1 Support**

This feature enables or disables onboard LAN1. The options are Disabled or **Enabled**.

**Onboard LAN2 Support**

This feature enables or disables onboard LAN2. The options are Disabled or **Enabled**.

**Onboard LAN Option ROM Type**

Use this feature to select which type of firmware to be loaded for the onboard LAN ports. The options are **Legacy** or UEFI.

**Onboard LAN1 Option ROM**

Select PXE (Preboot Execution Environment) to boot the computer using a PXE device installed in a LAN port specified. Select Disabled to prevent system boot using a device installed in a LAN port. The options are **Disabled** or PXE.

**Onboard LAN2 Option ROM**

Select PXE (Preboot Execution Environment) to boot the computer using a PXE device installed in a specified LAN port. Select Disabled to prevent system boot using a device installed in a LAN port. The options are Disabled or PXE.

## Network Stack

Select Enabled to enable PXE (Preboot Execution Environment) or UEFI (Unified Extensible Firmware Interface) for network stack support. The options are **Enabled** or Disabled. If this feature is enabled, the next two features are available.

### Ipv4 PXE Support

Select Enabled to enable Ipv4 PXE (Preboot Execution Environment) for boot support. If this feature is set to Disabled, Ipv4 PXE boot option will not be supported. The options are **Disabled** or Enabled.

### Ipv6 PXE Support

Select Enabled to enable Ipv6 PXE (Preboot Execution Environment) for boot support. If this feature is set to Disabled, Ipv6 PXE boot option will not be supported. The options are **Disabled** or Enabled.

## ► Security

Use this submenu to create Administrator and User passwords. Using ONLY an Administrator password limits access to BIOS setup. Using ONLY a User password will lock unauthorized users from booting the system and/or entering BIOS setup.

## ► Secure Boot

**System Mode** - Setup

**Secure Boot** - Not Active

**Vendor Keys** - Active

### Secure Boot Enable

When a Platform Key(PK) is enrolled, this feature may be enabled.

## ► Enter Audit Mode

*\*This submenu can only be used if current System Mode is set to User.  
The PK variable will be erased on transition to Audit Mode.*

## Secure Boot Mode

This feature allows selection of the Secure Boot Mode between Standard and Custom. Selecting Custom enables users to change the Image Execution Policy and manage Secure Boot Keys. The options are **Custom** or Standard.

### ▶ Reset to Setup Mode

This feature deletes the contents of all UEFI Secure Boot key databases. This will result in entering Setup Mode.

### ▶ Restore Factory Keys

This feature resets the content of all UEFI Secure Boot key databases to factory defaults.

### ▶ Key Management

#### Provision Factory Defaults

This feature provisions factory default keys on the next system boot while in Setup Mode. The options are **Disabled** or Enabled.

### ▶ Restore Factory Keys

This feature resets the content of all UEFI Secure Boot key databases to factory defaults.

### ▶ Enroll Efi Image

When an EFI image is available, this feature allows the image to run in Secure Boot mode.

### ▶ Export Secure Boot variables

### ▶ Platform Key (PK)

This feature allows the user to configure the settings of the platform keys.

### **Set New**

Select "Set New" to load the new platform keys (PK) from the manufacturer's defaults, then select Yes to load factory default keys or No to load an external file. To cancel the operation before selecting "Set New", select either OK or Cancel (both work).

## **► Key Exchange Keys**

### **Set New**

Select "Set New" to load the new key exchange keys (KEK) from the manufacturer's defaults, then select Yes to load factory default keys or No to load an external file. To cancel the operation before selecting "Set New", select either OK or Cancel (both work).

### **Append**

Select "Append" to load the new key exchange keys (KEK) from the manufacturer's defaults, then select Yes to load factory default keys or No to load an external file. To cancel the operation before selecting "Set New", select either OK or Cancel (both work).

## **► Authorized Signatures**

### **Set New**

Select "Set New" to load the authorized signatures (DB) from the manufacturer's defaults, then select Yes to load factory default keys or No to load an external file. To cancel the operation before selecting "Set New", select either OK or Cancel (both work).

### **Append**

Select "Append" to load the new authorized signatures (DB) from the manufacturer's defaults, then select Yes to load factory default keys or No to load an external file. To cancel the operation before selecting "Set New", select either OK or Cancel (both work).

## ► Forbidden Signatures

### **Set New**

Select "Set New" to load the forbidden signatures (DBX) from the manufacturer's defaults, then select Yes to load factory default keys or No to load an external file. To cancel the operation before selecting "Set New", select either OK or Cancel (both work).

### **Append**

Select "Append" to load the new forbidden signatures (DBX) from the manufacturer's defaults, then select Yes to load factory default keys or No to load an external file. To cancel the operation before selecting "Set New", select either OK or Cancel (both work).

## ► Authorized TimeStamps

### **Set New**

Select "Set New" to load the new authorized time stamps (DBT) from the manufacturer's defaults, then select Yes to load factory default keys or No to load an external file. To cancel the operation before selecting "Set New", select either OK or Cancel (both work).

### **Append**

Select "Append" to load the new authorized time stamps (DBT) from the manufacturer's defaults, then select Yes to load factory default keys or No to load an external file. To cancel the operation before selecting "Set New", select either OK or Cancel (both work).

## ► OSRecovery Signature

### **Set New**

Select "Set New" to load the OSRecovery Signatures (DBR) from the manufacturer's defaults, then select Yes to load factory default keys or No to load an external file. To cancel the operation before selecting "Set New", select either OK or Cancel (both work).

## **Append**

Select "Append" to load the OSRecovery Signatures (DBR) from the manufacturer's defaults, then select Yes to load factory default keys or No to load an external file. To cancel the operation before selecting "Set New", select either OK or Cancel (both work).

## 4-8 IPMI



**Note:** The following features and submenus reflect Core™ i7 7900X/7740X and i5 7640X CPUs.

### BMC Firmware Revision

### IPMI STATUS

### ▶ System Event Log

### Enabling/Disabling Options

### SEL Components

This feature enables or disables all aspects of System Event Logging during boot. The options are Disabled or **Enabled**.

### Erasing Settings

### Erase SEL

This feature controls if/when to erase SEL. The options are **No**; Yes, On next reset; Yes, On every reset.

### **When SEL is Full**

This feature controls what happens with a full SEL. The options are **Do Nothing** or Erase Immediately.

### **Custom EFI Logging Options**

#### **Log EFI Status Codes**

This feature controls what EFI codes get logged. The options are Disabled, **Error code**, Progress code, and Both (error and progress).

### **► BMC Network Configuration**

This menu displays BMC information:

### **Configure IPv4 support**

#### **IPMI LAN Selection**

#### **IPMI Network Link Status**

#### **Update IPMI LAN Configuration**

When enabled, the IPv4 settings below will be set to IPMI during the next system boot.

#### **Configuration Address source**

This feature controls how to configure the LAN channel. The options are **Static** or DHCP(dynamic).

#### **Station IP address**

#### **Subnet mask**

#### **Station MAC address**

#### **Gateway IP Address**

#### **VLAN**

## Configure IPV6 support

### Lan channel 1

#### IPV6 Support

Use this feature to enable IPV6 support for LAN1. The options are Disabled and **Enabled**.

#### Configuration Address source

Use this feature to select the LAN channel parameters. The options are **Unspecified**, Static, DHCP.

*\*If the feature above is set to Static, Station IPV6 address, Prefix Length, and IPV6 Router1 IP Address are available for configuration. If DyanmicBmcDhcp is selected, no features are available for configuration.*

- **Current Configuration Address source**

#### Station IPV6 address

Use this feature to enter the station IPV6 address. Select the feature and enter the address.

#### Prefix Length

Select a value to change the prefix length.

#### IPV6 Router1 IP Address

Use this feature to enter the IPV6 router1 TP address. Select the feature and enter the address.

- **IPV6 address status**
- **IPV6 DHCP Algorithm**

#### IPMI Function Support

This feature enables IPMI function support. The options are **Disabled** or Enabled.

## 4-9 Boot



### Boot Configuration

#### Setup Prompt Timeout

Enter the wait time in seconds to wait for the setup activation key. Enter 65535 for indefinite wait time. The default is **1**.

#### Boot mode select

Use this feature to select the boot mode. The options are **LEGACY**, UEFI, and DUAL.

#### FIXED BOOT ORDER Priorities

Use this feature to set the boot order priority. The number of boot options shown is dependent on the boot mode selected (above).

#### ▶ Delete Driver Option

#### ▶ NETWORK Drive BBS Priorities

This feature allows the user to specify which UEFI network drive devices are boot devices.

- **Boot Option #1**

▶ **Save Changes and Reset**

This feature resets the system after saving changes.

▶ **Discard Changes and Reset**

This feature resets the system without saving changes.

▶ **Save Changes**

This feature saves changes, but does not reset the system.

▶ **Discard Changes**

This feature discards changes, but does not reset the system.

▶ **Restore Defaults**

This feature restores defaults to all setup options.

▶ **Save as User Defaults**

This feature saves all changes made so far and makes them the new defaults.

▶ **Restore User Defaults**

This feature restores all setup options to the user defaults.

## 4-10 BIOS Update



This feature is used to update the BIOS version manually. Two columns of information are shown. The left column shows CURRENT BIOS information. The right column shows NEW BIOS information. Use the **"Start Update"** item to begin flashing the new BIOS.

## Appendix A

### BIOS Error Beep Codes

During the POST (Power-On Self-Test) routines, which are performed each time the system is powered on, errors may occur.

**Non-fatal errors** are those which, in most cases, allow the system to continue with bootup. The error messages normally appear on the screen.

**Fatal errors** will not allow the system to continue to bootup. If a fatal error occurs, you should consult with your system manufacturer for possible repairs.

These fatal errors are usually communicated through a series of audible beeps. The numbers on the fatal error list correspond to the number of beeps for the corresponding error.

#### A-1 BIOS Error Beep Codes

| BIOS Error Beep Codes       |               |  |
|-----------------------------|---------------|--|
| Beep Code/LED               | Error Message | Description                                      |
| 1 beep                      | Refresh       | Circuits have been reset.<br>(Ready to power up) |
| 5 short beeps + 1 long beep | Memory error  | No memory detected in the system                 |
| 5 short beeps               | Display error | System display error                             |
| OH LED On                   | System OH     | System Overheat                                  |

## Notes

## Appendix B

### Software Installation Instructions

#### B-1 Installing Drivers

After you've installed the Windows operating system, a screen as shown below will appear. You are ready to install software programs and drivers that have not yet been installed. To install these software programs and drivers, click the icons to the right of these items. (**Note:** To install the Windows operating system, please refer to the instructions posted on our website at [http://www.supermicro.com/support/manuals/.](http://www.supermicro.com/support/manuals/))

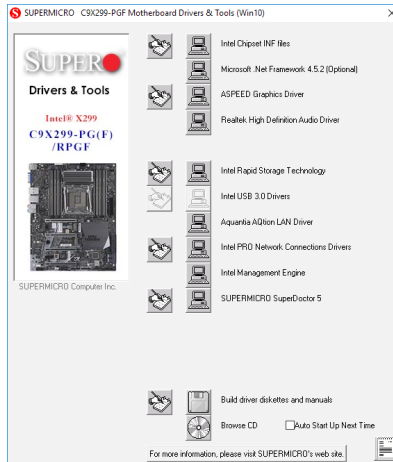

#### Driver/Tool Installation Display Screen



**Note 1:** Click the icons showing a hand writing on the paper to view the readme files for each item. Click on a computer icon to the right of an item to install this item (from top to the bottom), one at a time. After installing each item, you must reboot the system before proceeding with the next item on the list. The bottom icon with a CD on it allows you to view the entire contents of the CD.

**Note 2:** When making a storage driver diskette by booting into a Driver CD, please set the SATA Configuration to "Compatible Mode" and configure SATA as IDE in the BIOS Setup. After making the driver diskette, be sure to change the SATA settings back to your original settings.

## B-2 Configuring SuperDoctor® 5

The Supermicro SuperDoctor 5 is a hardware monitoring program that functions in a command-line or web-based interface in Windows and Linux operating systems. The program monitors system health information such as CPU temperature, system voltages, system power consumption, fan speed, and provides alerts via email or Simple Network Management Protocol (SNMP).

SuperDoctor 5 comes in local and remote management versions and can be used with Nagios to maximize your system monitoring needs. With SuperDoctor 5 Management Server (SSM Server), you can remotely control power on/off and reset chassis intrusion for multiple systems with SuperDoctor 5 or IPMI. SD5 Management Server monitors HTTP, FTP, and SMTP services to optimize the efficiency of your operation.



**Note:** The default Username and Password for SuperDoctor 5 is admin / admin. The SuperDoctor 5 program and user's manual can be downloaded from the Supermicro website at [http://www.supermicro.com/products/nfo/sms\\_sd5.cfm](http://www.supermicro.com/products/nfo/sms_sd5.cfm).



**SuperDoctor 5 Interface Display Screen-1 (Health Information)**

## Appendix C

### UEFI BIOS Recovery Instructions

**!** **Attention!** Do not upgrade the BIOS unless your system has a BIOS-related issue. Flashing the wrong BIOS can cause irreparable damage to the system. In no event shall Supermicro be liable for direct, indirect, special, incidental, or consequential damages arising from a BIOS update. If you need to update the BIOS, do not shut down or reset the system while the BIOS is updating to avoid possible boot failure.

#### C-1 An Overview to the UEFI BIOS

The Unified Extensible Firmware Interface (UEFI) specification provides a software-based interface between the operating system and the platform firmware in the pre-boot environment. The UEFI specification supports an architecture-independent mechanism for add-on card initialization to allow the UEFI OS loader, which is stored in the add-on card, to boot up the system. UEFI offers a clean, hands-off control to a computer system at bootup.

#### C-2 How to Recover the UEFI BIOS Image (the Main BIOS Block)

A UEFI BIOS flash chip consists of a recovery BIOS block, comprised of two boot blocks and a main BIOS block (a main BIOS image). The boot block contains critical BIOS codes, including memory detection and recovery codes for the user to flash a new BIOS image if the original main BIOS image is corrupted. When the system power is on, the boot block codes execute first. Once that is completed, the main BIOS code will continue with system initialization and bootup.



**Note:** Follow the BIOS Recovery instructions below for BIOS recovery when the main BIOS boot crashes.

## C-3 To Recover the Main BIOS Block Using a USB-Attached Device

This feature allows the user to recover a BIOS image using a USB-attached device without additional utilities used. A USB flash device such as a USB Flash Drive, or a USB CD/DVD ROM/RW device can be used for this purpose. However, a USB Hard Disk drive cannot be used for BIOS recovery at this time.

To perform UEFI BIOS recovery using a USB-attached device, follow the instructions below.

1. Using a different machine, copy the "Super.ROM" binary image file into the disc Root "\ " Directory of a USB device or a writeable CD/DVD.



**Note:** If you cannot locate the "SUPER.ROM" file in your driver disk, visit our website at [www.supermicro.com](http://www.supermicro.com) to download the BIOS image into a USB flash device (save in the root folder) and rename it "SUPER.ROM" for BIOS recovery use.

2. Insert the USB device that contains the new BIOS image ("SUPER.ROM") into any available USB port. Be sure the file is saved in the very top (root) folder.
3. With the USB device inserted, power on the system. If the screen appears as below, press <DEL> to continue.

```
Version 2.19.1266. Copyright (C) 2017 American Megatrends, Inc.
```

```
Supermicro C9X299 BIOS Date:09/08/2017 Rev:1.0
```

```
CPU : Intel(R) Core(TM) i7-7900X CPU @ 3.30GHz
```

```
Speed : 3.30 GHz
```

```
The IMC is operating with DDR4 2132 MHz
```

```
Press DEL to run Setup
```

```
Press F11 to invoke Boot Menu
```

```
Press F12 to boot from PXE/LAN
```

- 4. After locating the new BIOS binary image, the system will enter the BIOS Recovery menu as shown below.

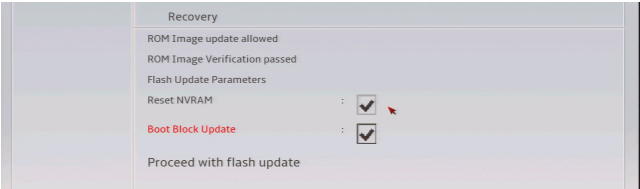

 **Note:** At this point, you may decide if you want to start with BIOS Recovery. If you decide to proceed with BIOS Recovery, follow the procedures below.

- 5. To continue with BIOS Recovery, select the item "Proceed with flash update". You will see the progress of BIOS Recovery as shown on the screens below.

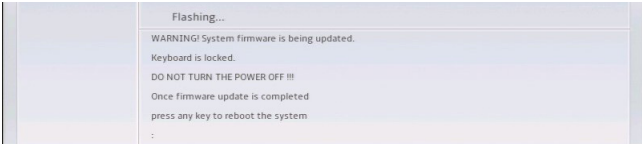

 **Note:** Do not interrupt the BIOS programming until it is completed.

- 6. After the BIOS Recovery process is complete, click OK to reboot the system.

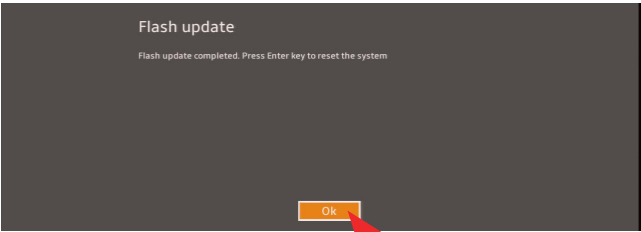

## Notes

(Disclaimer Continued)

The products sold by Supermicro are not intended for and will not be used in life support systems, medical equipment, nuclear facilities or systems, aircraft, aircraft devices, aircraft/emergency communication devices or other critical systems whose failure to perform be reasonably expected to result in significant injury or loss of life or catastrophic property damage. Accordingly, Supermicro disclaims any and all liability, and should buyer use or sell such products for use in such ultra-hazardous applications, it does so entirely at its own risk. Furthermore, buyer agrees to fully indemnify, defend and hold Supermicro harmless for and against any and all claims, demands, actions, litigation, and proceedings of any kind arising out of or related to such ultra-hazardous use or sale.