

SUPER ●[®]

**X10SRA
X10SRA-F
USER'S MANUAL**

Revision 1.1b

The information in this User's Manual has been carefully reviewed and is believed to be accurate. The vendor assumes no responsibility for any inaccuracies that may be contained in this document, makes no commitment to update or to keep current the information in this manual, or to notify any person or organization of the updates. **Please Note: For the most up-to-date version of this manual, please see our web site at www.supermicro.com.**

Super Micro Computer, Inc. ("Supermicro") reserves the right to make changes to the product described in this manual at any time and without notice. This product, including software and documentation, is the property of Supermicro and/or its licensors, and is supplied only under a license. Any use or reproduction of this product is not allowed, except as expressly permitted by the terms of said license.

IN NO EVENT WILL SUPERMICRO BE LIABLE FOR DIRECT, INDIRECT, SPECIAL, INCIDENTAL, SPECULATIVE OR CONSEQUENTIAL DAMAGES ARISING FROM THE USE OR INABILITY TO USE THIS PRODUCT OR DOCUMENTATION, EVEN IF ADVISED OF THE POSSIBILITY OF SUCH DAMAGES. IN PARTICULAR, SUPERMICRO SHALL NOT HAVE LIABILITY FOR ANY HARDWARE, SOFTWARE, OR DATA STORED OR USED WITH THE PRODUCT, INCLUDING THE COSTS OF REPAIRING, REPLACING, INTEGRATING, INSTALLING OR RECOVERING SUCH HARDWARE, SOFTWARE, OR DATA.

Any disputes arising between manufacturer and customer shall be governed by the laws of Santa Clara County in the State of California, USA. The State of California, County of Santa Clara shall be the exclusive venue for the resolution of any such disputes. Super Micro's total liability for all claims will not exceed the price paid for the hardware product.

FCC Statement: This equipment has been tested and found to comply with the limits for a class B digital device, pursuant to Part 15 of the FCC Rules. These limits are designed to provide reasonable protection against harmful interference in a residential installation. This equipment generates, uses, and can radiate radio frequency energy and, if not installed and used in accordance with the instructions, may cause harmful interference to radio communications. However, there is no guarantee that interference will not occur in a particular installation. If this equipment does cause harmful interference to radio or television reception, which can be determined by turning the equipment off and on, the user is encouraged to try to correct the interference by one or more of the following measures:

- Reorient or relocate the receiving antenna.
- Increase the separation between the equipment and receiver.
- Connect the equipment to an outlet on a circuit different from that to which the receiver is connected.
- Consult the authorized dealer or an experienced radio/TV technician for help.

California Best Management Practices Regulations for Perchlorate Materials: This Perchlorate warning applies only to products containing CR (Manganese Dioxide) Lithium coin cells. "Perchlorate Material-special handling may apply. See www.dtsc.ca.gov/hazardouswaste/perchlorate"

WARNING: Handling of lead solder materials used in this product may expose you to lead, a chemical known to the State of California to cause birth defects and other reproductive harm.

Manual Revision 1.1b

Release Date: August 17, 2016

Unless you request and receive written permission from Super Micro Computer, Inc., you may not copy any part of this document.

Information in this document is subject to change without notice. Other products and companies referred to herein are trademarks or registered trademarks of their respective companies or mark holders.

Copyright © 2016 by Super Micro Computer, Inc. All rights reserved.

Printed in the United States of America

Preface

This manual is written for system integrators, PC technicians and knowledgeable PC users. It provides information for the installation and use of the **SUPER** X10SRA/X10SRA-F motherboard.

Manual Organization

Chapter 1 describes the features, specifications and performance of the motherboard, and provides detailed information on the Intel C612 Express chipset.

Chapter 2 provides hardware installation instructions. Read this chapter when installing the processor, memory modules and other hardware components into the system.

If you encounter any problems, see **Chapter 3**, which describes troubleshooting procedures for video, memory and system setup stored in the CMOS.

Chapter 4 includes an introduction to the BIOS, and provides detailed information on running the CMOS Setup utility.

Appendix A provides BIOS Error Beep Codes.

Appendix B lists software program installation instructions.

Appendix C contains UEFI BIOS Recovery instructions.

Appendix D contains an introduction and instructions regarding the Dual Boot Block feature of this motherboard.

Checklist

Congratulations on purchasing your computer motherboard from an acknowledged leader in the industry. Supermicro boards are designed with the utmost attention to detail to provide you with the highest standards in quality and performance.

Please check that the following items have all been included with your motherboard. If anything listed here is damaged or missing, contact your retailer.

The following items are included in the retail box.

- One (1) Supermicro Motherboard
- Six (6) SATA cables (single packed/boxed only) or,
- Two (2) SATA cables (bulk packed only)
- One (1) I/O shield
- One (1) Quick Reference Guide

Conventions Used in the Manual

Special attention should be given to the following symbols for proper installation and to prevent damage done to the components or injury to yourself:



Attention! Critical information to prevent damage to the components or injury to yourself.



Important: Important information given to ensure proper system installation or to relay safety precautions.



Note: Additional Information given to differentiate various models or provides information for correct system setup.

Standardized Warning Statements

The following statements are industry-standard warnings, provided to warn the user of situations which have the potential for bodily injury. Should you have questions or experience difficulty, contact Supermicro's Technical Support department for assistance. Only certified technicians should attempt to install or configure components.

Read this section in its entirety before installing or configuring components in the Supermicro chassis.

Battery Handling



Warning!

There is a danger of explosion if the battery is replaced incorrectly. Replace the battery only with the same or equivalent type recommended by the manufacturer. Dispose of used batteries according to the manufacturer's instructions

電池の取り扱い

電池交換が正しく行われなかった場合、破裂の危険性があります。交換する電池はメーカーが推奨する型、または同等のものを使用下さい。使用済電池は製造元の指示に従って処分して下さい。

警告

電池更換不當會有爆炸危險。請只使用同類電池或製造商推薦的功能相當的電池更換原有電池。請按製造商的說明處理廢舊電池。

警告

電池更換不當會有爆炸危險。請使用製造商建議之相同或功能相當的電池更換原有電池。請按照製造商的說明指示處理廢棄舊電池。

Warnung

Bei Einsetzen einer falschen Batterie besteht Explosionsgefahr. Ersetzen Sie die Batterie nur durch den gleichen oder vom Hersteller empfohlenen Batterietyp. Entsorgen Sie die benutzten Batterien nach den Anweisungen des Herstellers.

Attention

Danger d'explosion si la pile n'est pas remplacée correctement. Ne la remplacer que par une pile de type semblable ou équivalent, recommandée par le fabricant. Jeter les piles usagées conformément aux instructions du fabricant.

iAdvertencia!

Existe peligro de explosión si la batería se reemplaza de manera incorrecta. Reemplazar la batería exclusivamente con el mismo tipo o el equivalente recomendado por el fabricante. Desechar las baterías gastadas según las instrucciones del fabricante.

אזהרה!

קיימת סכנת פיצוץ של הסוללה במידה והוחלפה בדרך לא תקינה. יש להחליף את הסוללה בסוג התואם מחברת יצרן מומלצת.

סילוק הסוללות המשומשות יש לבצע לפי הוראות היצרן.

هناك خطر من انفجار في حالة استبدال البطارية بطريقة غير صحيحة فعليك استبدال البطارية فقط بنفس النوع أو ما يعادلها كما أوصت به الشركة المصنعة تخلص من البطاريات المستعملة وفقا لتعليمات الشركة الصانعة

경고!

배터리가 올바르게 교체되지 않으면 폭발의 위험이 있습니다. 기존 배터리와 동일하거나 제조사에서 권장하는 동등한 종류의 배터리로만 교체해야 합니다. 제조사의 안내에 따라 사용된 배터리를 처리하여 주십시오.

Waarschuwing

Er is ontploffingsgevaar indien de batterij verkeerd vervangen wordt. Vervang de batterij slechts met hetzelfde of een equivalent type die door de fabrikant aanbevolen wordt. Gebruikte batterijen dienen overeenkomstig fabrieksvoorschriften afgevoerd te worden.

Product Disposal



Warning!

Ultimate disposal of this product should be handled according to all national laws and regulations.

製品の廃棄

この製品を廃棄処分する場合、国の関係する全ての法律・条例に従い処理する必要があります。

警告

本产品的废弃处理应根据所有国家的法律和规章进行。

警告

本產品的廢棄處理應根據所有國家的法律和規章進行。

Warnung

Die Entsorgung dieses Produkts sollte gemäß allen Bestimmungen und Gesetzen des Landes erfolgen.

iAdvertencia!

Al deshacerse por completo de este producto debe seguir todas las leyes y reglamentos nacionales.

Attention

La mise au rebut ou le recyclage de ce produit sont généralement soumis à des lois et/ou directives de respect de l'environnement. Renseignez-vous auprès de l'organisme compétent.

סילוק המוצר

אזהרה!

סילוק סופי של מוצר זה חייב להיות בהתאם להנחיות וחוקי המדינה.

عند التخلص النهائي من هذا المنتج ينبغي التعامل معه وفقا لجميع القوانين واللوائح الوطنية

경고!

이 제품은 해당 국가의 관련 법규 및 규정에 따라 폐기되어야 합니다.

Waarschuwing

De uiteindelijke verwijdering van dit product dient te geschieden in overeenstemming met alle nationale wetten en reglementen.

Contacting Supermicro

Headquarters

Address: Super Micro Computer, Inc.
980 Rock Ave.
San Jose, CA 95131 U.S.A.

Tel: +1 (408) 503-8000

Fax: +1 (408) 503-8008

Email: marketing@supermicro.com (General Information)
support@supermicro.com (Technical Support)

Web Site: www.supermicro.com

Europe

Address: Super Micro Computer B.V.
Het Sterrenbeeld 28, 5215 ML
's-Hertogenbosch, The Netherlands

Tel: +31 (0) 73-6400390

Fax: +31 (0) 73-6416525

Email: sales@supermicro.nl (General Information)
support@supermicro.nl (Technical Support)
rma@supermicro.nl (Customer Support)

Asia-Pacific

Address: Super Micro Computer, Inc.
4F, No. 232-1, Liancheng Rd
Chung-Ho Dist., New Taipei City 235
Taiwan

Tel: +886-(2) 8226-3990

Fax: +886-(2) 8226-3991

Web Site: www.supermicro.com.tw

Technical Support:

Email: support@supermicro.com.tw

Tel: +886-(2)-8226-3990

Where to Find More Information

For your system to work properly, please follow the links below to download all necessary drivers/utilities and the user's manual for your motherboard.

SMCI product manuals: <http://www.supermicro.com/support/manuals/>

Product Drivers and utilities: <ftp://ftp.supermicro.com/>

If you have any questions, please contact our support team at support@supermicro.com.

Table of Contents

Preface

Manual Organization	iii
Checklist	iv
Conventions Used in the Manual	iv
Standardized Warning Statements	v
Battery Handling.....	v
Product Disposal.....	vi
Contacting Supermicro.....	viii
Where to Find More Information.....	ix

Chapter 1

Introduction

1-1 Overview	1-1
About this Motherboard	1-1
1-2 Chipset Overview	1-1
Intel C612 Express Chipset Features	1-1
1-3 Motherboard Features	1-2
1-4 Special Features	1-4
Recovery from AC Power Loss	1-4
1-5 PC Health Monitoring.....	1-4
Fan Status Monitor with Firmware Control	1-4
Environmental Temperature Control	1-4
System Resource Alert	1-5
1-6 ACPI Features	1-5
Slow Blinking LED for Suspend-State Indicator.....	1-5
1-7 Power Supply	1-6
1-8 Super I/O	1-6

Chapter 2

Installation

2-1 Installation Components and Tools Needed	2-1
2-2 Static-Sensitive Devices.....	2-2
Precautions.....	2-2
Unpacking.....	2-2
2-3 Processor and Heatsink Installation.....	2-3
Installing the Processor	2-3
Installing a CPU Heatsink.....	2-7

	Removing a Heatsink	2-8
2-4	Installing DDR4 Memory	2-9
	DIMM Installation	2-9
	Removing Memory Modules.....	2-9
	Memory Population Guidelines	2-10
	Memory Support.....	2-10
2-5	Motherboard Installation	2-13
	Tools Needed.....	2-13
	Location of Mounting Holes	2-13
	Installing the Motherboard	2-14
2-6	Connectors/IO Ports.....	2-15
	Back I/O Panel	2-15
	Universal Serial Bus (USB)	2-16
	Ethernet Ports	2-17
	Back Panel High Definition Audio (HD Audio)	2-17
	PS/2 Keyboard/Mouse Port	2-18
	VGA Port (X10SRA-F only)	2-18
	Front Control Panel	2-19
	Front Control Panel Pin Definitions	2-20
	Power LED	2-20
	HDD LED	2-20
	NIC1/NIC2 (LAN1/LAN2)	2-20
	Overheat (OH)/Fan Fail	2-20
	NMI Button	2-21
	Power Fail	2-21
	Reset Button	2-21
	Power Button	2-21
2-7	Connecting Cables	2-22
	ATX Main PWR & CPU PWR Connectors (JPW1 & JPW2)	2-22
	Fan Headers (Fan 1 ~ Fan 5)	2-23
	Chassis Intrusion (JL1)	2-23
	Internal Buzzer (SP1)	2-24
	Speaker (JD1)	2-24
	DOM PWR Connector (JSD1).....	2-25
	Standby Power Header (STBY1).....	2-25
	System Management Bus (JIPMB1)	2-25
	TPM Header (JTPM1)	2-26
	Power Supply I ² C (JPI2C1)	2-26
	Front Panel Audio Header (AUDIO FP)	2-27

2-8	Jumper Settings	2-28
	Explanation of Jumpers	2-28
	LAN1/LAN2 Enable/Disable	2-28
	Clear CMOS (JBT1, CLR_CMOS_SW, S8)	2-29
	PCI Slot SMB Enable (I ² C1/I ² C2).....	2-29
	Audio Enable (JPAC1)	2-30
	Watch Dog Enable/Disable.....	2-30
	USB Wake-Up (JUSB1).....	2-31
	Manufacturing Mode (JPME2).....	2-32
	VGA Enable/Disable (JPG1)	2-32
	BMC Enable/Disable (JPB1)	2-32
	BIOS Recovery Switch (JBR1).....	2-33
	Power Button (S4)	2-33
	BIOS Restore (S11).....	2-33
2-9	Onboard Indicators.....	2-34
	LAN 1/LAN 2 LEDs	2-34
	BMC Heartbeat (LEDM1)	2-34
	Power LED (LE2)	2-35
	Status Display (LED4)	2-35
2-10	SATA Connections.....	2-36
	SATA Connections (I-SATA0~5, S-SATA0~3).....	2-36

Chapter 3

Troubleshooting

3-1	Troubleshooting Procedures.....	3-1
	Before Power On.....	3-1
	No Power.....	3-1
	No Video	3-2
	Memory Errors	3-2
	When the System is Losing the Setup Configuration	3-2
3-2	Technical Support Procedures	3-3
3-3	Frequently Asked Questions	3-4
3-4	Battery Removal and Installation	3-5
	Battery Removal	3-5
	Proper Battery Disposal	3-5
3-5	Returning Motherboard for Service.....	3-6
	Battery Installation	3-6

Chapter 4**BIOS**

4-1	Introduction	4-1
	Starting BIOS GUI Setup Utility	4-1
	How To Change the Configuration Data	4-2
	How to Start the Setup Utility	4-2
4-2	Saving and Loading.....	4-3
	Save and Load	4-3
	Restore Defaults	4-4
	Save All Settings Only	4-4
	Save Changes and Exit	4-4
	Save Changes and Reset.....	4-4
	Discard Changes	4-4
	Exit without Save.....	4-4
	Discard Changes and Reset	4-4
	Booting	4-4
4-3	System Information	4-6
	Motherboard	4-6
	System Date	4-6
	System Time	4-6
4-4	Processor (CPU).....	4-7
	Information.....	4-7
	Performance.....	4-8
	Hyper-threading [ALL]	4-8
	Execute-Disable Bit Capability.....	4-8
	Intel® Virtualization Technology	4-8
	Enable SMX	4-9
	PPIN Control.....	4-9
	Hardware Prefetcher	4-9
	Adjacent Cache Line Prefetch	4-9
	DCU Streamer Prefetcher	4-9
	DCU IP Prefetcher	4-9
	Direct Cache Access (DCA Support).....	4-9
	X2APIC	4-9
	AES-NI	4-9
	Power Management.....	4-10
	EIST	4-10

	Turbo Mode	4-10
	P-STATE Coordination	4-11
4-5	Chipset.....	4-12
	System Agent.....	4-12
	Intel VT for Directed I/O (VT-d).....	4-13
	PCH I/O.....	4-14
	Azalia (HD Audio)	4-14
	On Board Chip.....	4-15
4-6	Memory	4-16
	Memory Information.....	4-16
	Memory Configuration	4-17
4-7	Event Logs	4-18
	SMBIOS Event Log	4-18
	Runtime Error Logging Support.....	4-18
	Memory Corrected Error Enabling.....	4-19
	Memory Correctable Error Threshold.....	4-19
	PCI-Ex (PCI-Express) Error Enable	4-19
	Erasing Settings.....	4-19
	Erase Event Log.....	4-19
	When Log is Full	4-19
	SMBIOS Event Log Standard Settings.....	4-19
	Log System Boot Event.....	4-19
	MECI (Multiple Event Count Increment)	4-19
	METW (Multiple Event Count Time Window)	4-19
4-8	Management.....	4-20
	ACPI Settings	4-20
	ACPI Sleep State	4-20
	High Precision Event Timer.....	4-20
	Console Redirection.....	4-21
	COM 1	4-21
	Enable Console Redirection.....	4-21
	SOL (X10SRA-F only)	4-23
	PCH-FW (Firmware)	4-27
4-9	IPMI	4-28
	IPMI.....	4-28
	System Event Log	4-28
	SEL Components.....	4-28
	Erasing Settings.....	4-29
	Erase SEL	4-29

When SEL is Full	4-29
BMC Network Configuration.....	4-29
Update IPMI LAN Configuration	4-29
Configuration Address Source	4-29
4-10 Input/Output.....	4-31
SATA	4-31
SATA Controller.....	4-31
Configure SATA as.....	4-31
sSATA.....	4-33
sSATA Controller	4-34
Configure sSATA as	4-34
PCIe/PCI/PnP	4-36
Above 4G Decoding	4-36
SR-IOV Support	4-36
PCI PERR/SERR Support	4-36
CPU SLOT1 PCI-E 3.0 X8 (IN X16) BIFURCATION.....	4-36
CPU SLOT6 PCI-E 3.0 X16 BIFURCATION	4-36
SLOT2 and SLOT4 Selection	4-37
CPU SLOT1 PCI-E 3.0 X8 (IN X16) - GEN X, CPU SLOT2 PCI-E 3.0 X8 (IN X16) - GEN X, CPU SLOT4 PCI-E 3.0 X8 (IN X16) - GEN X, CPU SLOT6 PCI-E 3.0 X16 - GEN X	4-37
CPU SLOT1 PCI-E 3.0 X8 (IN X16) OPROM, CPU SLOT2 PCI-E 3.0 X8 (IN X16) OPROM, PCH SLOT3 PCI-E 2.0 X1 (IN X4) OPROM, CPU SLOT4 PCI-E 3.0 X8 (IN X16) OPROM, PCH SLOT5 PCI-E 2.0 X1 (IN X4) OPROM, CPU SLOT6 PCI-E 3.0 X16 OPROM	4-37
Video Option ROM Type (X10SRA-F).....	4-37
Onboard LAN Option ROM Type.....	4-37
Onboard LAN1 Option ROM/Onboard LAN2 Option ROM	4-37
Network Stack	4-37
ASPM Support.....	4-38
VGA Priority	4-38
USB Settings.....	4-39
Legacy USB Support.....	4-39
XHCI Hand-Off.....	4-39
EHCI Hand-Off.....	4-39
XHCI Mode.....	4-40
EHCI1.....	4-40
EHCI2.....	4-40

Super IO Configuration.....	4-40
Serial Port 1 Configuration	4-40
Current Config (IRQ)	4-40
Change (IRQ) Settings.....	4-41
4-11 Security	4-41
Password	4-41
Administrator Password.....	4-42
User Password	4-42
User Password	4-42
Secure Boot	4-42
Secure Boot	4-43
Secure Boot Mode	4-43
Key Management	4-43
Default Key Provision.....	4-43
Enroll All Factory Default Keys	4-43
Save All Secure Boot Variables	4-43
Platform Key	4-43
Delete PK.....	4-43
Set New PK.....	4-43
Key Exchange Key.....	4-44
Delete KEK.....	4-44
Set New KEK.....	4-44
Append KEK	4-44
Authorized Signatures.....	4-44
Delete DBT.....	4-44
Set New DBT	4-44
Append DBT	4-45
Forbidden Signatures.....	4-45
Delete DBX	4-45
Set New DBX.....	4-45
Append DBX.....	4-45
4-12 Booting	4-46
Boot Device Settings.....	4-46
Quiet Boot	4-46
Boot Mode Select.....	4-46
Fixed Boot Order Priorities	4-46
Delete Driver Option.....	4-48
Network Drive BBS Priorities	4-48

UEFI Application BBS Priorities.....	4-48
BIOS Features	4-48
Bootup Numlock State	4-48
AddOn ROM Display Mode	4-48
Wait for "F1" for Error	4-49
Interrupt 19 Capture	4-49
Retry Boot	4-49
Watch Dog Function	4-49
Power Button Function.....	4-49
Restore on AC Power Loss.....	4-49
CSM Support	4-49
EUP Support.....	4-50
Fast Boot	4-50

Appendix A

BIOS Error Beep Codes

A-1 BIOS Error Beep Codes	A-1
---------------------------------	-----

Appendix B

Software Installation Instructions

B-1 Installing Drivers	B-1
B-2 Configuring SuperDoctor® III	B-2

Appendix C

UEFI BIOS Recovery Instructions

C-1 An Overview to the UEFI BIOS	C-1
C-2 How to Recover the UEFI BIOS Image (-the Main BIOS Block)	C-1
C-3 To Recover the Main BIOS Block Using a USB-Attached Device....	C-2

Appendix D

Dual Boot Block

D-1 Introduction	D-1
BIOS Boot Block.....	D-1
BIOS Boot Block Corruption Occurrence	D-1
D-2 Steps to Reboot the System by switch JBR1	D-2

Notes

Chapter 1

Introduction

1-1 Overview

About this Motherboard

The X10SRA/X10SRA-F Motherboard supports a single Intel® E5-26xx series , E5-16xx series or Core™ i7 processor, in an LGA 2011-3 socket. With the Intel® C612 chipset built in, the X10SRA/X10SRA-F motherboard offers substantial system performance and storage capability for workstation/server platforms. Please refer to our website (<http://www.supermicro.com/products/>) for processor and memory support updates.

1-2 Chipset Overview

Intel C612 Express Chipset Features

- DDR4 288-pin memory support on the LGA 2011-3
- Support for MCTP Protocol and ME
- Support of SMBus speeds of up to 1 MHz for BMC connectivity
- GSX capable of GPIO expansion
- Improved I/O capabilities to high-storage-capacity configuration
- SPI Enhancements
- Intel® Node Manager 3.0
- BMC supports remote management, virtualization, and the security package for enterprise platforms



Notes:

1. E5-2600v4 requires Revision 2.0 BIOS (or higher).

1-3 Motherboard Features

CPU	Single E5-26xx series, E5-16xx series, Intel® Core™ i7 Series CPU, LGA2011-3 socket.	
	 Note: E5-2600v4 requires Revision 2.0 BIOS (or higher).	
Memory	Supports up to 512GB of ECC LRDIMM sizes, up to 2400MHz, or 256 ECC RDIMM sizes, up to 2400MHz, or up to 64GB ECC/Non-ECC Unbuffered UDIMM (for Core i7 only), up to 2400MHz, in 8 memory slots.	
	Four-channel memory	
	DIMM sizes	
	UDIMM	1 GB, 2 GB, 4GB, and 8GB
Chipset	Intel® C612 Express	
Expansion Slots	Four (4) PCI Express 3.0 x16, running at 16/16/NA/8 or 16/8/8/8.	
	Two (2) PCI Express 2.0 x1 (in x4) slots	
Network Connections	Two (2) Gigabit Ethernet Controllers, Intel i210-AT gigabit LAN controller. IPMI support shared with LAN1.	
	Two (2) RJ-45 rear I/O panel connectors with Link and Activity LEDs	
I/O Devices	SATA Connections	
	I-SATA 3.0 (6Gb/s)	Six (6) Total (I-SATA0~5)
		Compatible with RAID 0, 1, 5, 10
	S-SATA3.0 (6Gb/s)	Four (4) Total (S-SATA0~3)
		Compatible with RAID 0, 1, 5, 10
	USB Devices	
	Eight (8) USB 3.0 ports: Six (6) ports on the rear I/O panel and Two (2) ports on one header	
	Keyboard/Mouse	
	One shared PS/2 Keyboard/Mouse port on the I/O rear I/O panel	
	Other I/O Ports	
One (1) VGA Port (X10SRA-F only)		
One (1) Serial Port header (COM1)		

	<p style="text-align: center;">Audio</p> <p>One (1) High Definition Audio 5.1 channel connector supported by Realtek ALC1150 on the back panel</p> <p>One (1) Front Panel Audio Header</p> <p>One (1) SPDIF In/Out on the rear side of the chassis</p> <p style="text-align: center;">Super I/O</p> <p>Nuvoton 6776</p>
BIOS	<p>128 Mb AMI BIOS® SPI Flash BIOS</p> <p>Plug and Play (PnP), DMI 2.3, PCI 2.3, ACPI 1.0/2.0/3.0, USB Keyboard and SMBIOS 2.7</p>
Power Configuration	<p>ACPI/ACPM Power Management</p> <p>Main Switch Override Mechanism</p> <p>Keyboard Wake-up from Soft-Off</p> <p>Power-on mode for AC power recovery</p>
Health Monitoring	<p style="text-align: center;">CPU Monitoring</p> <p>Onboard voltage monitors for +1.05V, +5V, +/- 12V, VBAT, Memory, CPU Core</p> <p>CPU 8-phase switching voltage regulator</p> <p>CPU/System overheat LED and control</p> <p>CPU Thermal Trip support</p> <p style="text-align: center;">Fan Control</p> <p>Fan status monitoring with firmware 4-pin fan speed control</p> <p>Low noise fan speed control</p>
System Management	<p>PECI (Platform Environment Configuration Interface) 2.0 support</p> <p>System resource alert via SuperDoctor® III</p> <p>SuperDoctor III, Watch Dog, NMI</p> <p>IPMI (for X10SRA-F only)</p> <p>Chassis Intrusion header and detection</p>
CD Utilities	<p>BIOS flash upgrade utility</p> <p>Drivers and software for Intel® C612 Express chipset utilities</p>
Other	ROHS 6/6 (Full Compliance, Lead Free)
Dimensions	ATX form factor (12.0" x 9.6") (304.8 mm x 243.84 mm)

1-4 Special Features

Recovery from AC Power Loss

Basic I/O System (BIOS) provides a setting for you to determine how the system will respond when AC power is lost and then restored to the system. You can choose for the system to remain powered off, (in which case you must press the power switch to turn it back on), or for it to automatically return to a power-on state. See the Advanced BIOS Setup section to change this setting. The default setting is **Last State**.

1-5 PC Health Monitoring

This section describes the PC health monitoring features of the board. All have an onboard System Hardware Monitoring chip that supports PC health monitoring. An onboard voltage monitor will scan these onboard voltages continuously: +1.05V, +5V, +/-12V, VBAT, Memory, CPU Core. Once a voltage becomes unstable, a warning is given, or an error message is sent to the screen. The user can adjust the voltage thresholds to define the sensitivity of the voltage monitor.

Fan Status Monitor with Firmware Control

PC health monitoring in the BIOS can check the RPM status of the cooling fans. The onboard CPU and chassis fans are controlled by Thermal Management via SIO.

Environmental Temperature Control

The thermal control sensor monitors the CPU temperature in real time and will turn on the thermal control fan whenever the CPU temperature exceeds a user-defined threshold. The overheat circuitry runs independently from the CPU. Once the thermal sensor detects that the CPU temperature is too high, it will automatically turn on the thermal fans to prevent the CPU from overheating. The onboard chassis thermal circuitry can monitor the overall system temperature and alert the user when the chassis temperature is too high.



Note: To avoid possible system overheating, please be sure to provide adequate airflow to your system.

System Resource Alert

This feature is available when the system is used with SuperDoctor III in the Windows OS environment or used with SuperDoctor II in Linux. SuperDoctor is used to notify the user of certain system events. For example, you can also configure SuperDoctor to provide you with warnings when the system temperature, CPU temperatures, voltages and fan speeds go beyond predefined thresholds.

1-6 ACPI Features

ACPI stands for Advanced Configuration and Power Interface. The ACPI specification defines a flexible and abstract hardware interface that provides a standard way to integrate power management features throughout a PC system, including its hardware, operating system and application software. This enables the system to automatically turn on and off peripherals such as CD-ROMs, network cards, hard disk drives and printers.

In addition to enabling operating system-directed power management, ACPI also provides a generic system event mechanism for Plug and Play, and an operating system-independent interface for configuration control. ACPI leverages the Plug and Play BIOS data structures, while providing a processor architecture-independent implementation that is compatible with Windows 7, Windows 8, and Windows 2008 Operating Systems.

Slow Blinking LED for Suspend-State Indicator

When the CPU goes into a suspend state, the chassis power LED will start to blink to indicate that the CPU is in suspend mode. When the user presses any key, the CPU will "wake up", and the LED will automatically stop blinking and remain on.

1-7 Power Supply

As with all computer products, a stable power source is necessary for proper and reliable operation. It is even more important for processors that have high CPU clock rates.

This motherboard accommodates 24-pin ATX power supplies. Although most power supplies generally meet the specifications required by the CPU, some are inadequate. In addition, the 12V 8-pin power connector located at JPW2 is also required to ensure adequate power supply to the system. Also your power supply must supply 1.5A for the Ethernet ports.

! Attention! To prevent damage to the power supply or motherboard, please use a power supply that contains a 24-pin and a 8-pin power connectors. Be sure to connect these connectors to the 24-pin (JPW1) and the 8-pin (JPW2) power connectors on the motherboard.

It is strongly recommended that you use a high quality power supply that meets ATX power supply Specification 2.02 or above. It must also be SSI compliant. (For more information, please refer to the web site at <http://www.ssiforum.org/>). Additionally, in areas where noisy power transmission is present, you may choose to install a line filter to shield the computer from noise. It is recommended that you also install a power surge protector to help avoid problems caused by power surges.

1-8 Super I/O

The Super I/O supports two high-speed, 16550 compatible serial communication ports (UARTs). Each UART includes a 16-byte send/receive FIFO, a programmable baud rate generator, complete modem control capability and a processor interrupt system. Both UARTs provide legacy speed with baud rate of up to 115.2 Kbps as well as an advanced speed with baud rates of 250 K, 500 K, or 1 Mb/s, which support higher speed modems.

The Super I/O provides functions that comply with ACPI (Advanced Configuration and Power Interface), which includes support of legacy and ACPI power management through an SMI or SCI function pin. It also features auto power management to reduce power consumption.

X10SRA/X10SRA-F Motherboard Image

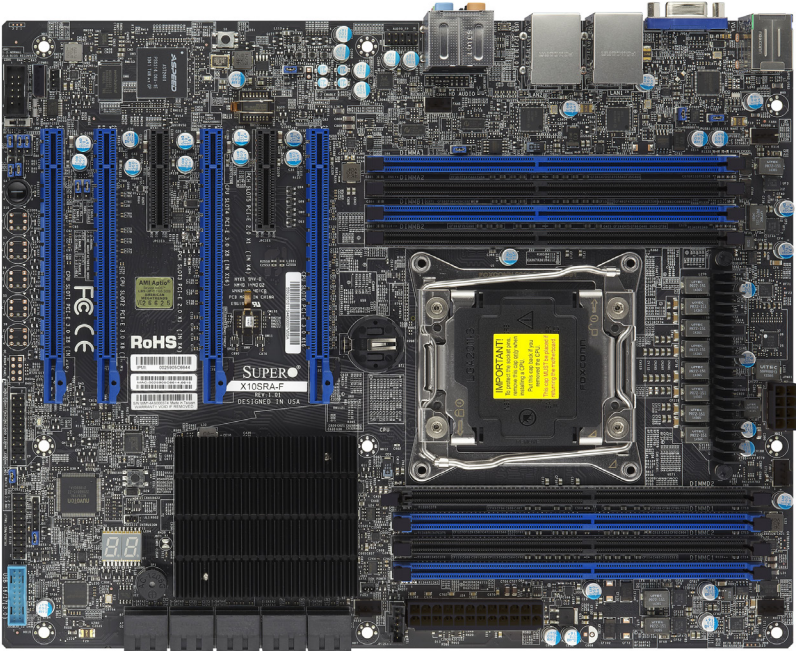

Note: All graphics shown in this manual were based upon the latest PCB Revision available at the time of publishing of the manual. The motherboard you've received may or may not look exactly the same as the graphics shown in this manual.

X10SRA/X10SRA-F Motherboard Layout

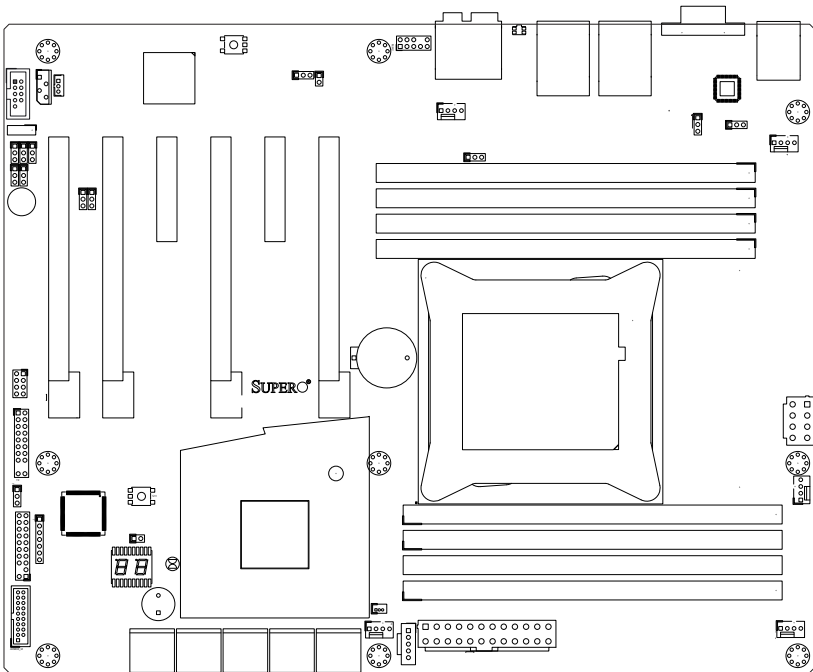

Important Notes to the User

- See Chapter 2 for detailed information on jumpers, I/O ports and JF1 front panel connections.
- "■" indicates the location of "Pin 1".
- Jumpers not indicated are for testing only.
- When LE2 (Onboard Power LED Indicator) is on, system power is on. Unplug the power cable before installing or removing any components.

X10SRA/X10SRA-F Motherboard Quick Reference

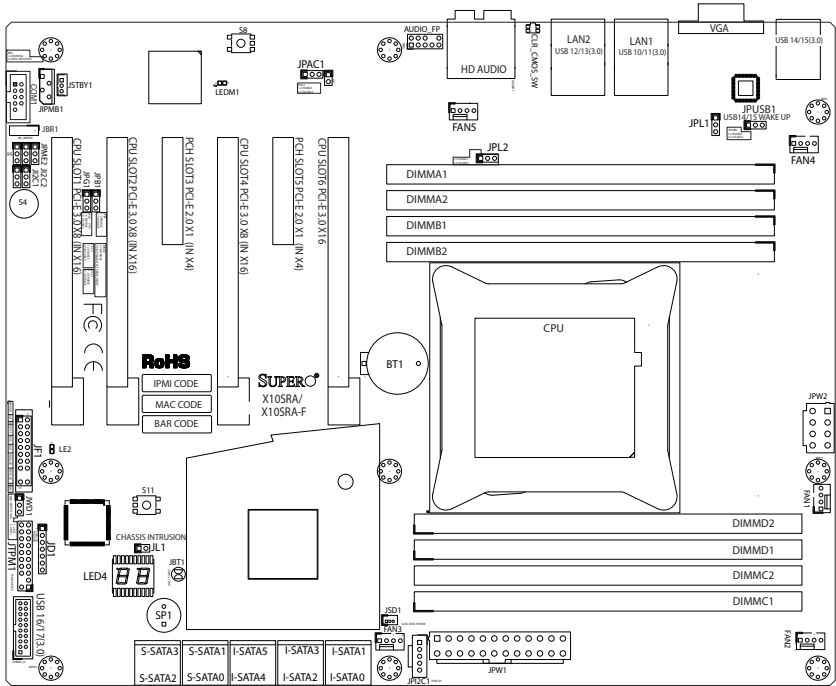

Jumper	Description	Default
JBT1*	Clear CMOS (on board)	(See Chpt. 2)
J ¹ C1/J ¹ C2	SMB to PCI Slots	Off (Disabled)
JPAC1	Audio Enable	Pins 1-2 (Enabled)
JPL1/JPL2	LAN1/LAN2 Enable	Pins 1-2 (Enabled)
JPME2	Intel Recovery Mode	Pins 2-3 (Disabled)
JWD1	Watch Dog Enable	Pins 2-3 (NMI)
JBR1	BIOS Recovery Mode	Pins 2-3 (Disabled)
JPUSB1	USB Wake Up Enable (Back Panel)	Pins 1-2 (Enabled)
JPB1	BMC Enable/Disable (X10SRA-F only)	Pins 1-2 (Enabled)
JPG1	Onboard VGA Enable (X10SRA-F only)	Pins 1-2 (Enabled)

* For the X10SRA-F, reboot time may be longer after clearing CMOS. This is due to the additional IPMI functions.

Connector	Description
I/O Back Panel	See Back Panel I/O Connectors, below right
Audio FP	Front Panel Audio Header
BT1	Onboard Battery
Fan 1,2,3,4,5	System/CPU Fan Headers (Fan1: CPU Fan)
JD1	Speaker/buzzer (Pins 1~4: External Speaker, Pins 3~4: Buzzer)
JF1	Front Panel Control Header
JL1	Chassis Intrusion Header
JPW1	24-pin ATX Main Power Connector (Required)
JPW2	+12V 4-pin CPU power Connector (Required)
JSD1	SATA DOM (Disk On Module) Power Connector
JSTBY1	Standby Power Header
SP1	Internal Speaker/Buzzer
I-SATA0~5	Serial ATA (SATA 3.0, 6Gb/sec), Supports RAID 0, 1, 5 & 10
S-SATA0~3	Serial ATA (SATA 3.0, 6Gb/sec), Supports RAID 0, 1, 5 & 10
USB 16/17	Front Panel Accessible USB 3.0 Headers 16/17
S4	Power Button
S11	Restores the BIOS from Firmware ('SUPER.ROM') on a USB memory device
S8	Clear CMOS Button (on board)
JPI2C1	Power Supply SMBbus I2C Header.
JTPM1	Trusted Platform Module Header
COM1	Serial Port Header for COM1
JIPMB1	System Management Bus header (for IPMI only)

LED	Description	Color/State	Status
LEDM1	BMC Heartbeat	Green: Blinking	BMC Normal
LED4	Status Display	Digital Readout	Download the status codes below**
LE2	Power LED	On: Steady	System On and Running

**Download the AMI status codes at http://www.ami.com/support/doc/ami_aptio_4.x_status_codes_pub.pdf

X10SRA/X10SRA-F Block Diagram

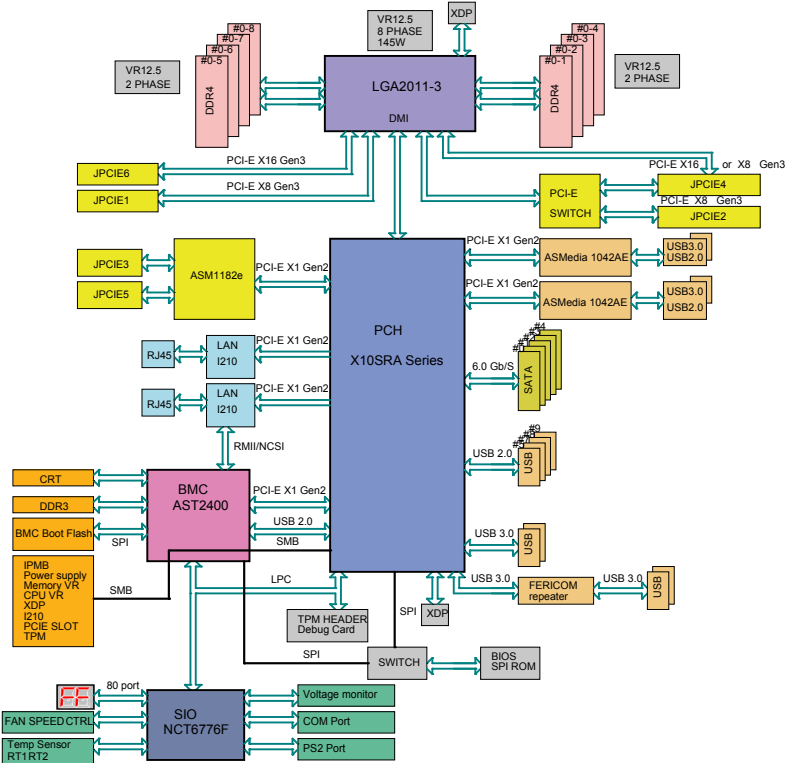

System Block Diagram



Note: This is a general block diagram and may not exactly represent the features on your motherboard. See the Motherboard Features pages for the actual specifications of each motherboard.

Notes

Chapter 2

Installation

2-1 Installation Components and Tools Needed

Screws

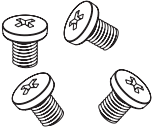

Phillips-Head Screwdriver

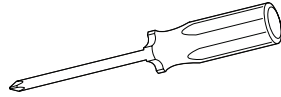

Processor

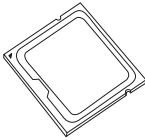

DDR4 DIMMs

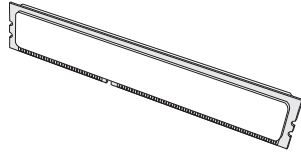

PC Chassis



Heatsink with Fan

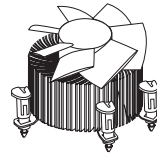

Power Supply

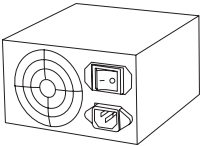

Video Card (Optional)

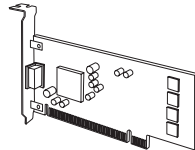

SATA/USB Optical Drive (Optional)

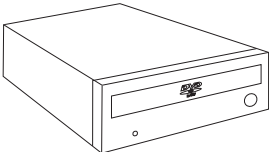

SATA Hard Disk Drive

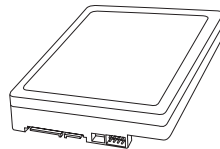

2-2 Static-Sensitive Devices

Electrostatic-Discharge (ESD) can damage electronic components. To avoid damaging your system board, it is important to handle it very carefully. The following measures are generally sufficient to protect your equipment from ESD.

Precautions

- Use a grounded wrist strap designed to prevent static discharge.
- Touch a grounded metal object before removing the board from the antistatic bag.
- Handle the board by its edges only; do not touch its components, peripheral chips, memory modules or gold contacts.
- When handling chips or modules, avoid touching their pins.
- Put the motherboard and peripherals back into their antistatic bags when not in use.
- For grounding purposes, make sure your computer chassis provides excellent conductivity between the power supply, the case, the mounting fasteners and the motherboard.
- Use only the correct type of onboard CMOS battery. Do not install the onboard battery upside down to avoid possible explosion.

Unpacking

The motherboard is shipped in antistatic packaging to avoid static damage. When unpacking the board, make sure that the person handling it is static protected.

2-3 Processor and Heatsink Installation

! **Attention!** When handling the processor package, avoid placing direct pressure on the label area of the fan.



Important:

Always connect the power cord last, and always remove it before adding, removing or changing any hardware components. Make sure that you install the processor into the CPU socket before you install the CPU heatsink.

If you buy a CPU separately, make sure that you use an Intel-certified multi-directional heatsink only.

Make sure to install the system board into the chassis before you install the CPU heatsink.

When receiving a server board without a processor pre-installed, make sure that the plastic CPU socket cap is in place and none of the socket pins are bent; otherwise, contact your retailer immediately.

Refer to the Supermicro website for updates on CPU support.

Installing the Processor

1. Using your thumb and the index finger, remove the 'WARNING' plastic cap from the socket.

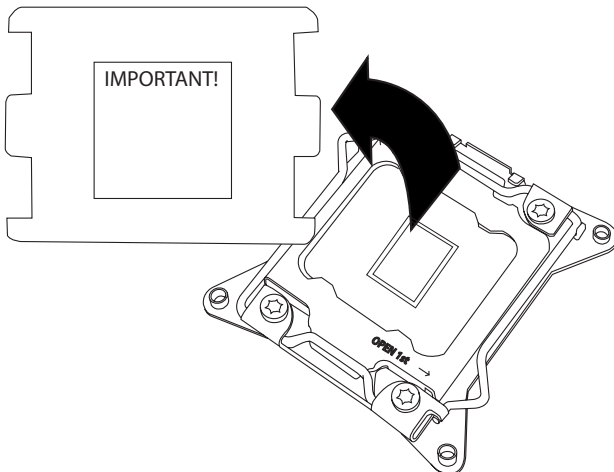

1. There are two load levers on the LGA2011-3 socket. To open the socket cover, first press and release the load lever labeled 'Open 1st'.

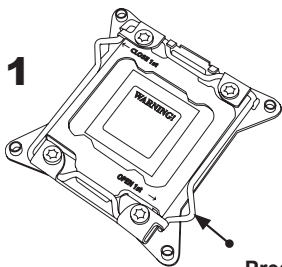

Press down on Load Lever labeled 'Open 1st'.

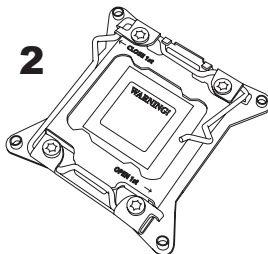

2. Press the second load lever labeled 'Close 1st' to release the load plate that covers the CPU socket from its locking position.

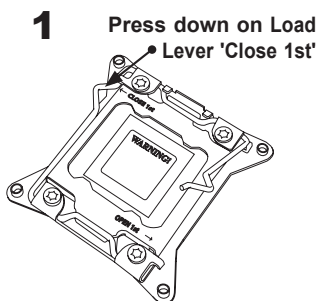

Press down on Load Lever 'Close 1st'

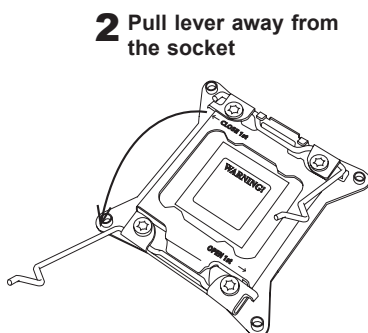

Pull lever away from the socket

3. With the 'Close 1st' lever fully retracted, gently push down on the 'Open 1st' lever to open the load plate. Lift the load plate to open it completely.

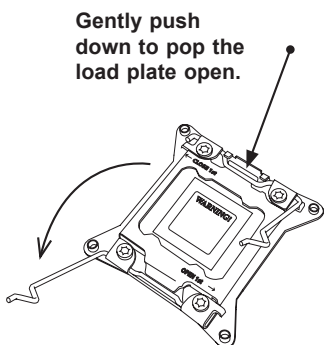

Gently push down to pop the load plate open.

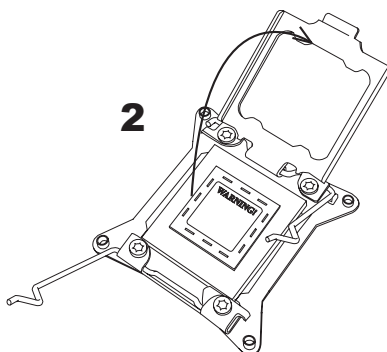

4. Use your thumb and index finger to hold the CPU on its edges. Align the CPU keys, which are semi-circle cutouts, against the socket keys.

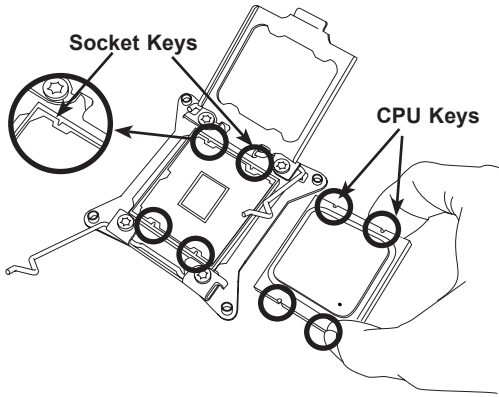

5. Once they are aligned, carefully lower the CPU straight down into the socket. (Do not drop the CPU on the socket. Do not move the CPU horizontally or vertically. Do not rub the CPU against the surface or against any pins of the socket to avoid damaging the CPU or the socket.)
6. With the CPU inside the socket, inspect the four corners of the CPU to make sure that the CPU is properly installed.

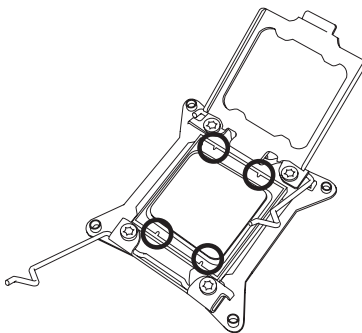

7. Close the load plate with the CPU inside the socket. Lock the 'Close 1st' lever first, then lock the 'Open 1st' lever second. Use your thumb to gently push the load levers down to the lever locks.

1 Gently close the load plate.

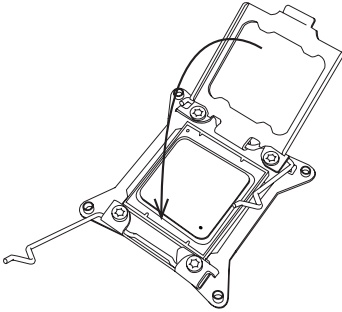

2 Push down and lock 'Close 1st' lever.

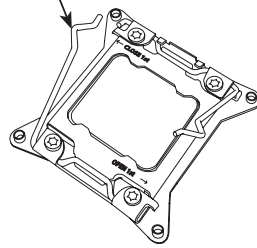

3 Lever Lock
Push down and lock 'Open 1st' lever

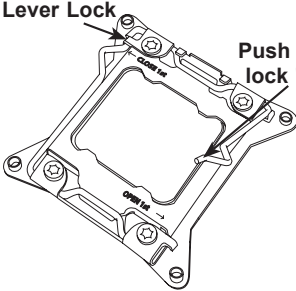

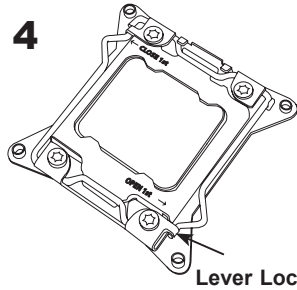

4 Lever Lock

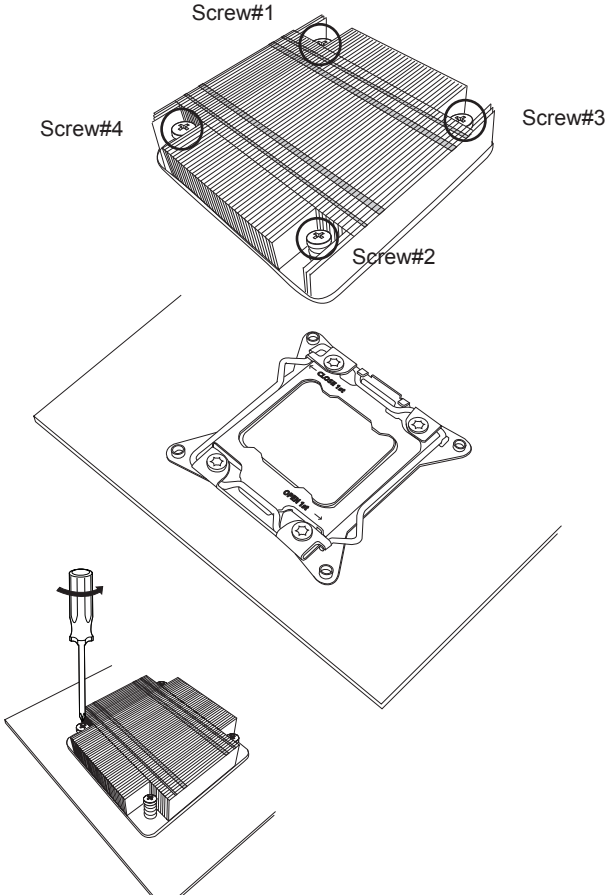

Installing a CPU Heatsink

1. Apply the proper amount of thermal grease to the heatsink.
2. Place the heatsink on top of the CPU so that the two mounting holes on the heatsink are aligned with those on the retention mechanism.



 **Note:** Graphic drawings included in this manual are for reference only. They might look different from the components installed in your system.

Removing a Heatsink

Warning: We do not recommend that the CPU or the heatsink be removed. However, if you do need to remove the heatsink, please follow the instructions below to uninstall the heatsink to avoid damaging the CPU or other components.

1. Unplug the power cord from the power supply.
2. Loosen the screws.
3. Gently wriggle the heatsink to loosen it. (Do not use excessive force when wriggling the heatsink.)

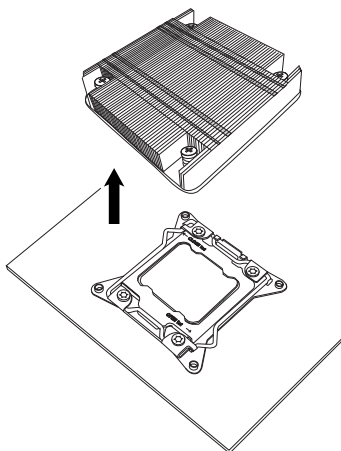

4. Once the heatsink is loosened, remove it from the motherboard.

2-4 Installing DDR4 Memory



Note: Check the Supermicro website for recommended memory modules.



Attention! Exercise extreme care when installing or removing DIMM modules to prevent any possible damage.

DIMM Installation

1. Insert the desired number of DIMMs into the memory slots, starting with DIMMA1 (see the next page for the location). For the system to work properly, please use the memory modules of the same type and speed in the same motherboard.

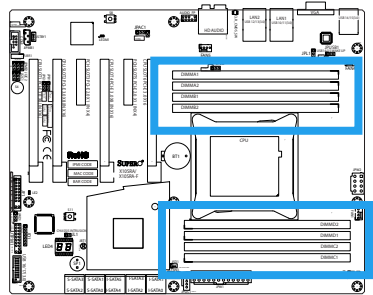

2. Push the release tabs outwards on both ends of the DIMM slot to unlock it.
3. Align the key of the DIMM module with the receptive point on the memory slot.
4. Align the notches on both ends of the module against the receptive points on the ends of the slot.
5. Use two thumbs together to press the notches on both ends of the module straight down into the slot until the module snaps into place.
6. Press the release tabs to the lock positions to secure the DIMM module into the slot.

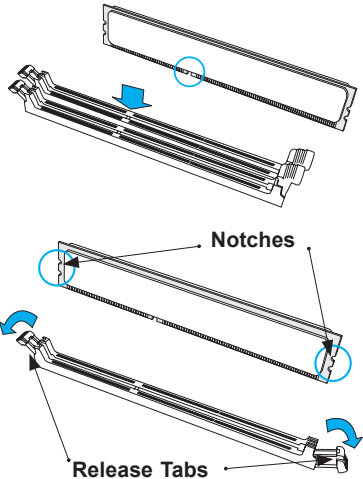

Press both notches straight down into the memory slot.

Removing Memory Modules

Reverse the steps above to remove the DIMM modules from the motherboard.

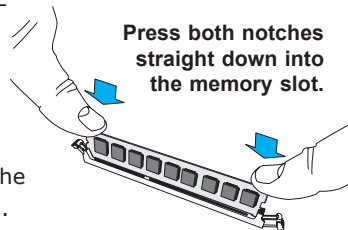

Memory Support

The X10SRA (-F) supports up to 512GB of ECC LRDIMM, up to 2400MHz, or 256GB ECC RDIMM, up to 2400MHz, or up to 64GB ECC/Non-ECC Unbuffered UDIMM (for Core i7 only), up to 2400MHz, in 8 memory slots. Populating these DIMM modules with a pair of memory modules of the same type and same size will result in interleaved memory, which will improve memory performance.



Note: For memory optimization, use only DIMM modules that have been validated by Supermicro. For the latest memory updates, please refer to our website at <http://www.supermicro.com/products/motherboard>.

Memory Population Guidelines

When installing memory modules, the DIMM slots should be populated in the following order: DIMMA1, DIMMB1, DIMMC1, DIMMD1 then DIMMA2, DIMMB2, DIMMC2, DIMMD2.

- Always use DDR4 DIMM modules of the same size, type and speed.

Memory Population Examples (Balanced)								
DIMMA1	DIMMB1	DIMMC1	DIMMD1	DIMMA2	DIMMB2	DIMMC2	DIMMD2	Total System Memory
4GB	4GB							8GB
4GB	4GB	4GB	4GB					16GB
4GB	4GB	4GB	4GB	4GB	4GB			24GB
4GB	4GB	4GB	4GB	4GB	4GB	4GB	4GB	32GB
8GB	8GB							16GB
8GB	8GB	8GB	8GB					32GB
8GB	8GB	8GB	8GB	8GB	8GB			48GB
8GB	8GB	8GB	8GB	8GB	8GB	8GB	8GB	64GB



I/O Back Panel

DIMMA1 (Blue Slot)

DIMMA2

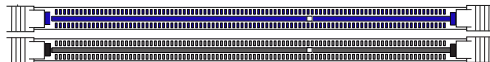

DIMMB1 (Blue Slot)

DIMMB2

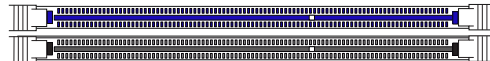

CPU

DIMMD2

DIMMD1 (Blue Slot)

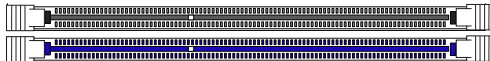

DIMMC2

DIMMC1 (Blue Slot)

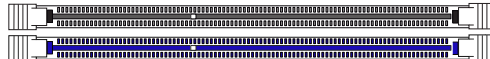

Notes

Be sure to use memory modules of the same type, same speed, same frequency on the same motherboard. Mixing of memory modules of different types and speeds is not allowed.

Due to memory allocation to system devices, the amount of memory that remains available for operational use will be reduced when 4 GB of RAM is used. The reduction in memory availability is disproportional. See the following table for details.

For Microsoft Windows users: Microsoft implemented a design change in the Windows XP with Service Pack 2 (SP2) and Windows Vista. This change is specific to the behavior of Physical Address Extension (PAE) mode which improves driver compatibility. For more information, please read the following article at Microsoft's Knowledge Base website at: <http://support.microsoft.com/kb/888137>.

Possible System Memory Allocation & Availability		
System Device	Size	Physical Memory Remaining (-Available) (4 GB Total System Memory)
Firmware Hub flash memory (System BIOS)	1 MB	3.99
Local APIC	4 KB	3.99
Area Reserved for the chipset	2 MB	3.99
I/O APIC (4 Kbytes)	4 KB	3.99
PCI Enumeration Area 1	256 MB	3.76
PCI Express (256 MB)	256 MB	3.51
PCI Enumeration Area 2 (if needed) -Aligned on 256-MB boundary-	512 MB	3.01
VGA Memory	16 MB	2.85
TSEG	1 MB	2.84
Memory available to OS and other applications		2.84

Populating RDIMM/LRDIMM DDR4 Memory Modules for the E5-2600v3-based Motherboard

Type	Ranks Per DIMM and Data Width	DIMM Capacity (GB)		Speed (MT/s); Voltage (V); Slot Per Channel (SPC) and DIMM Per Channel (DPC)		
				1 Slot Per Channel	2 Slots Per Channel	
		4Gb	8Gb	1DPC	1DPC	2DPC
		4Gb	8Gb	1.2V	1.2V	1.2V
RDIMM	SRx4	8GB	16GB	2133	2133	1866
RDIMM	SRx8	4GB	8GB	2133	2133	1866
RDIMM	DRx8	8GB	16GB	2133	2133	1866
RDIMM	DRx4	16GB	32GB	2133	2133	1866
LRDIMM	QRx4	32GB	64GB	2133	2133	2133
LRDIMM † 3DS	8Rx4	64GB	128GB	2133	2133	2133

Populating RDIMM/LRDIMM DDR4 Memory Modules for the E5-2600v4-based Motherboard

Type	Ranks Per DIMM and Data Width	DIMM Capacity (GB)		Speed (MT/s); Voltage (V); Slot Per Channel (SPC) and DIMM Per Channel (DPC)		
				1 Slot Per Channel	2 Slots Per Channel	
		4Gb	8Gb	1DPC	1DPC	2DPC
		4Gb	8Gb	1.2V	1.2V	1.2V
RDIMM	SRx4	8GB	16GB	2400	2400	2133
RDIMM	SRx8	4GB	8GB	2400	2400	2133
RDIMM	DRx8	8GB	16GB	2400	2400	2133
RDIMM	DRx4	16GB	32GB	2400	2400	2133
LRDIMM	QRx4	32GB	64GB	2400	2400	2400
LRDIMM 3DS	8Rx4	64GB	128GB	2400	2400	2400

2-5 Motherboard Installation

All motherboards have standard mounting holes to fit different types of chassis. Make sure that the locations of all the mounting holes for both motherboard and chassis match. Although a chassis may have both plastic and metal mounting fasteners, metal ones are highly recommended because they ground the motherboard to the chassis. Make sure that the metal standoffs click in or are screwed in tightly. Then use a screwdriver to secure the motherboard onto the motherboard tray.



Philips Screwdriver
(1)



Philips Screws (9)



Standoffs (9)
Only if Needed

Tools Needed

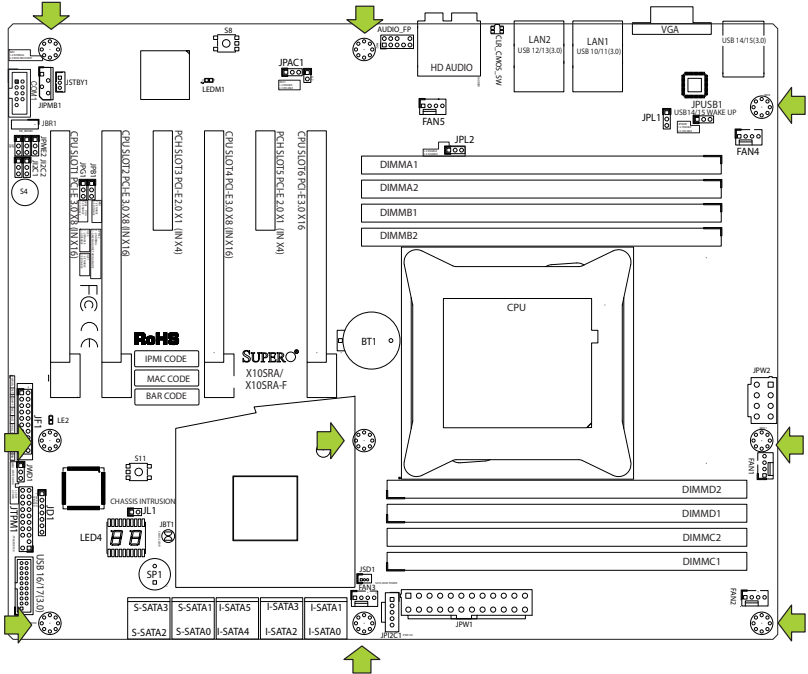

Location of Mounting Holes

- ! Attention!** 1) To avoid damaging the motherboard and its components, please do not use a force greater than 8 lb/inch on each mounting screw during motherboard installation. 2) Some components are very close to the mounting holes. Please take precautionary measures to avoid damaging these components when installing the motherboard to the chassis.

Installing the Motherboard

1. Install the I/O shield into the back of the chassis.

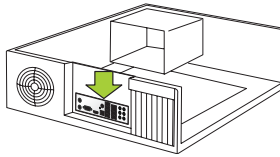

2. Locate the mounting holes on the motherboard. (See the previous page.)
3. Locate the matching mounting holes on the chassis. Align the mounting holes on the motherboard against the mounting holes on the chassis.

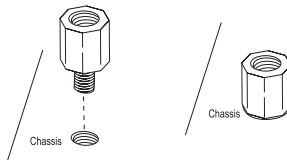

4. Install standoffs in the chassis as needed.
5. Install the motherboard into the chassis carefully to avoid damaging other motherboard components.

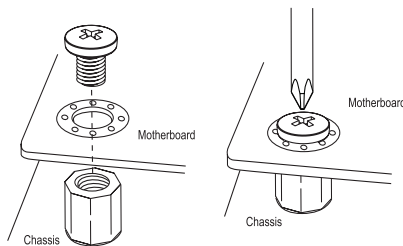

6. Using the Phillips screwdriver, insert a Phillips head #6 screw into a mounting hole on the motherboard and its matching mounting hole on the chassis.
7. Repeat Step 5 to insert #6 screws into all mounting holes.
8. Make sure that the motherboard is securely placed in the chassis.



Note: Images displayed are for illustration only. Your chassis or components might look different from those shown in this manual.

2-6 Connectors/IO Ports

The I/O ports are color coded in conformance with the PC 99 specification. See the figure below for the colors and locations of the various I/O ports.

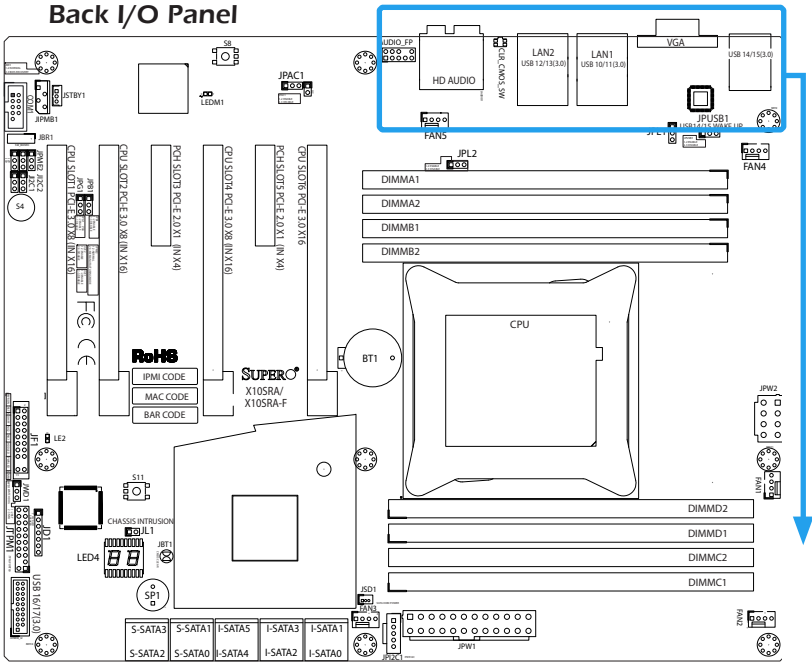

A. PS/2 Keyboard/Mouse Port	H. Gb LAN Port 2	L. Center/LFE Out
B. USB 3.0 Port 14	I. USB 3.0 Port 12	M. Surround Out
C. USB 3.0 Port 15	J. USB 3.0 Port 13	N. S/PDIF Out
D. VGA Port*	K. Clear CMOS	O. Line In
E. Gb LAN Port 1 (shared IPMI*)		P. Line Out
F. USB 3.0 Port 10		Q. Mic In
G. USB 3.0 Port 11		

* X10SRA-F only

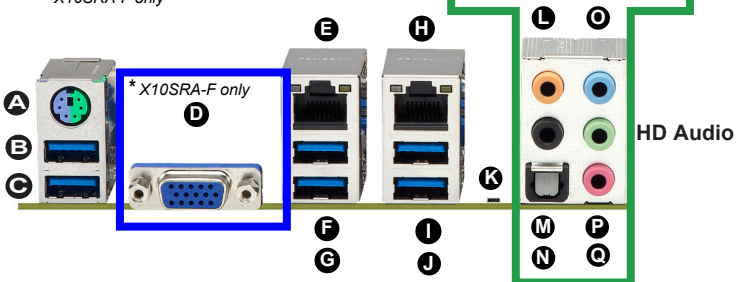

Universal Serial Bus (USB)

Six USB 3.0 ports (10/11, 12/13, 14/15) are located on the I/O back panel. In addition, one USB 3.0 header (USB 16/17) is also located on the motherboard to provide front chassis access using USB cables (not included). These ports are backward compatible with the USB 2.0 standard. See the tables below for pin definitions.

Front Panel USB (3.0) Header #16/17 Pin Definitions			
Pin#	Definition	Pin#	Definition
1	+5V	11	U2DP_B
2	U3RXN_A	12	U2DM_B
3	U3RXP_A	13	Ground
4	Ground	14	U3TXP_B
5	U3TXN_A	15	U3TXN_B
6	U3TXP_A	16	Ground
7	Ground	17	U3RXP_B
8	U2DM_A	18	U3RXN_B
9	U2DP_A	19	+5V
10	USB30_OC signal		

Back Panel USB (3.0) Ports 10/11, 12/13 Pin Definitions			
Pin#	Pin#	Signal Name	Description
1	10	VBUS	Power
2	11	D-	USB 2.0 Differential Pair
3	12	D+	
4	13	Ground	Ground of PWR Return
5	14	StdA_SSRX-	SuperSpeed Receiver
6	15	StdA_SSRX+	Differential Pair
7	16	GND_DRAIN	Ground for Signal Return
8	17	StdA_SSTX-	SuperSpeed Transmitter
9	18	StdA_SSTX+	Differential Pair

Back Panel USB (3.0) Ports 14/15 Pin Definitions			
Pin#	Pin#	Signal Name	Description
B1	A1	VBUS	Power
B2	A2	D-	USB 2.0 Differential Pair
B3	A3	D+	
B4	A4	Ground	Ground of PWR Return
B5	A5	StdA_SSRX-	SuperSpeed Receiver
B6	A6	StdA_SSRX+	Differential Pair
B7	A7	GND_DRAIN	Ground for Signal Return
B8	A8	StdA_SSTX-	SuperSpeed Transmitter
B9	A9	StdA_SSTX+	Differential Pair

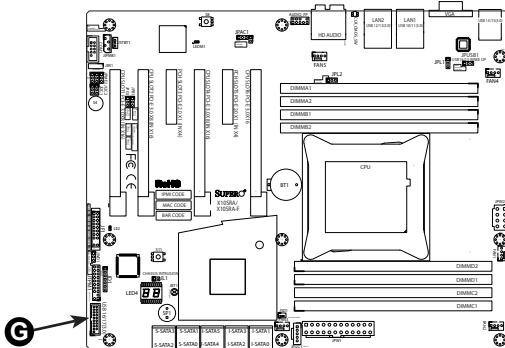
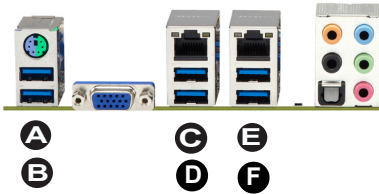

- A. Backpanel USB 3.0 #14
- B. Backpanel USB 3.0 #15
- C. Backpanel USB 3.0 #10
- D. Backpanel USB 3.0 #11
- E. Backpanel USB 3.0 #12
- F. Backpanel USB 3.0 #13
- G. USB 3.0 Header #16/17

Ethernet Ports

Two Gigabit Ethernet ports (LAN1/LAN2) are located next to the HD Audio Connector on the I/O Backpanel to provide network connections. These ports accept RJ45 type cables.



Note: Please refer to the LED Indicator Section for LAN LED information.

Back Panel High Definition Audio (HD Audio)

This motherboard features a 5.1+2 Channel High Definition Audio (HDA) codec that provides 10 DAC channels. The HD Audio connections simultaneously supports multiple-streaming 5.1 sound playback with 2 channels of independent stereo output through the front panel stereo out for front, rear, center and subwoofer speakers. Use the Advanced software included in the CD-ROM with your motherboard to enable this function.

LAN Ports Pin Definition			
Pin#	Desc	Pin#	Desc
1	VBUS1	21	TD0-
2	DN1	22	TD1+
3	DP1	23	TD1-
4	GND1	24	TD2+
5	SSRXN1	25	TD2-
6	SSRXP1	26	TD3+
7	GND_DRAIN1	27	TD3-
8	SSTXN1	28	SGND
9	SSTXP1	29	Orange-
10	VBUS2	30	Green-
11	DN2	31	Yellow+
12	DP2	32	Yellow-
13	GND2	33	SGND1
14	SSRXN2	34	SGND2
15	SSRXP2	35	SGND3
16	GND_DRAIN2	36	SGND4
17	SSTXN2	37	SGND5
18	SSTXP2	38	SGND6
19	VCT	39	SGND7
20	TD0+	40	SGND8

- A. LAN1
- B. LAN2
- C. Center/LFE Out
- D. Surround Out
- E. S/PDIF Out
- F. Line In
- G. Line Out
- H. Mic In

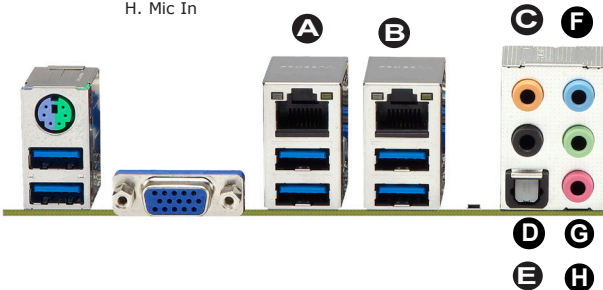

PS/2 Keyboard/Mouse Port

A combination PS/2 Keyboard/Mouse port is supported on the back panel. This may be used with either a PS/2 keyboard or PS/2 mouse, or both when using a 'Y' PS/2 cable.



VGA Port (X10SRA-F only)

A VGA port is located next to the USB ports 0/1 on the I/O backpanel. Use this port to connect to a compatible VGA display.



A. PS/2 Keyboard/Mouse Port
B. VGA Port



Front Control Panel

JF1 contains header pins for various buttons and indicators that are normally located on a control panel at the front of the chassis. These connectors are designed specifically for use with Supermicro chassis. See the figure below for the descriptions of the front control panel buttons and LED indicators. Refer to the following section for descriptions and pin definitions.

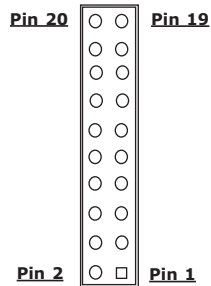
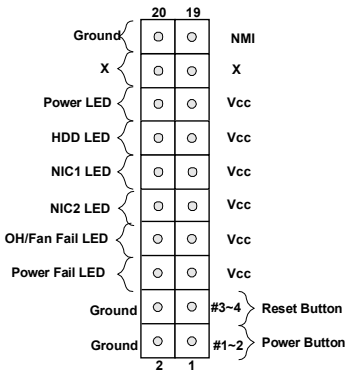
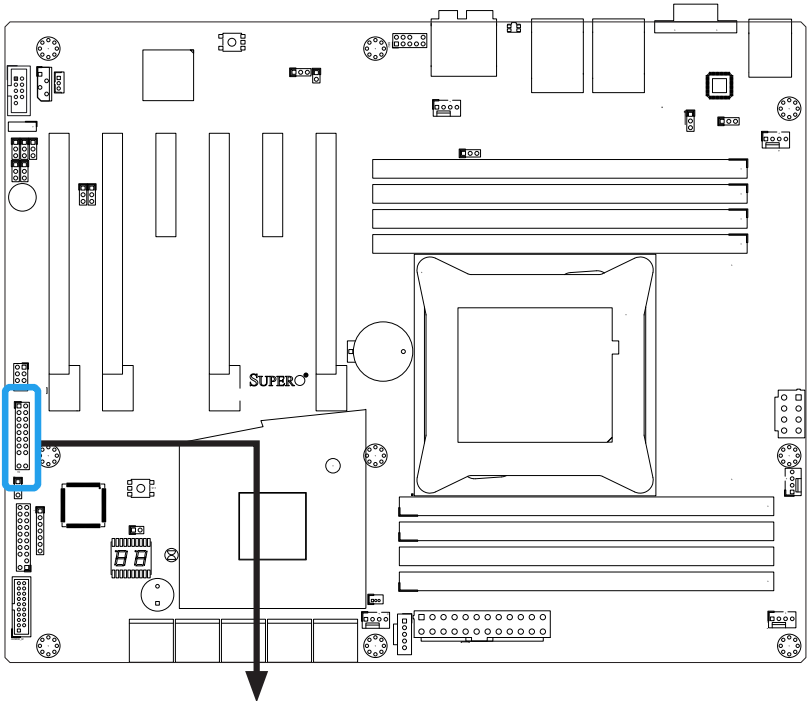

JF1 Header Pins

Front Control Panel Pin Definitions

Power LED

The Power LED connection is located on pins 15 and 16 of JF1. Refer to the table on the right for pin definitions.

Power LED Pin Definitions (JF1)	
Pin#	Definition
15	+3.3V
16	PWR LED

HDD LED

The HDD LED connection is located on pins 13 and 14 of JF1. Attach a cable here to indicate the status of HDD-related activities, including IDE, SATA activities. See the table on the right for pin definitions.

HDD LED Pin Definitions (JF1)	
Pin#	Definition
13	+3.3V
14	HD Active

NIC1/NIC2 (LAN1/LAN2)

The NIC (Network Interface Controller) LED connection for LAN port 1 is located on pins 11 and 12 of JF1, and the LED connection for LAN Port 2 is on Pins 9 and 10. NIC1 LED and NIC2 LED are 2-pin NIC LED headers. Attach NIC LED cables to NIC1 and NIC2 LED indicators to display network activities. Refer to the table on the right for pin definitions.

NIC1/NIC2 LED Pin Definitions (JF1)	
Pin#	Definition
9/11	3.3V
10/12	NIC2 LED / NIC1 LED

Overheat (OH)/Fan Fail

Connect an LED cable to OH/Fan Fail connections on pins 7 and 8 of JF1 to provide warnings for chassis overheat/fan failure. Refer to the table on the right for pin definitions.

OH/Fan Fail LED Pin Definitions (JF1)	
Pin#	Definition
7	3.3V
8	OH/Fan Fail LED

OH/Fan Fail Indicator Status	
State	Definition
Off	Normal
On	Overheat
Flashing	Fan Fail

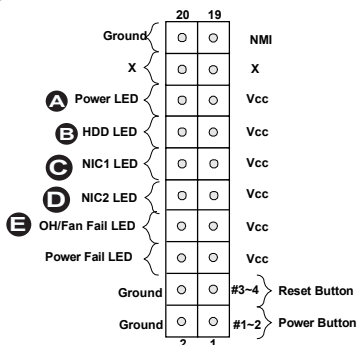

- A. PWR LED
- B. HDD LED
- C. NIC1 LED
- D. NIC2 LED
- E. OH/Fan Fail

NMI Button

The non-maskable interrupt button-header is located on pins 19 and 20 of JF1. Refer to the table on the right for pin definitions.

NMI Pin Definitions (JF1)	
Pin#	Definition
19	NMI
20	Ground

Power Fail

Connect an LED cable to the Power Fail connection to provide a warning that a power failure has occurred. Refer to the table on the right for pin definitions.

Power Fail LED Pin Definitions (JF1)	
Pin#	Definition
5	3.3V
6	Power Fail LED

Reset Button

The Reset Button connection is located on pins 3 and 4 of JF1. Attach it to a hardware reset switch on the computer case to reset the system. Refer to the table on the right for pin definitions.

Power Fail LED Status	
State	Definition
Off	Normal
Flash- ing	Power Fail

Power Button

The Power Button connection is located on pins 1 and 2 of JF1. Momentarily contacting both pins will power on/off the system. This button can also be configured to function as a suspend button (with a setting in the BIOS - see Chapter 4). To turn off the power in the suspend mode, press the button for at least 4 seconds. Refer to the table on the right for pin definitions.

Reset Button Pin Definitions (JF1)	
Pin#	Definition
3	Reset
4	Ground

Power Button Pin Definitions (JF1)	
Pin#	Definition
1	Power Button
2	GND

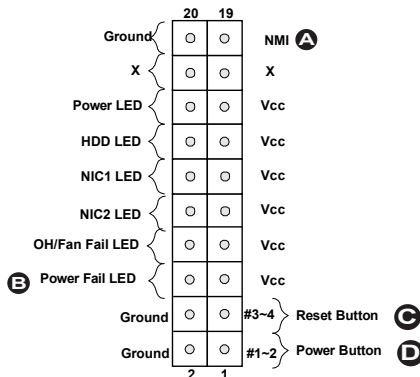

- A. NMI
- B. PWR Fail LED
- C. Reset Button
- D. PWR Button

2-7 Connecting Cables

This section provides brief descriptions and pin-out definitions for on-board headers and connectors. Be sure to use the correct cable for each header or connector.

ATX Main PWR & CPU PWR Connectors (JPW1 & JPW2)

The 24-pin main power connector (JPW1) is used to provide power to the motherboard. The 8-pin CPU PWR connector (JPW2) is also required for the processor. These power connectors meet the SSI EPS 12V specification. See the table on the right for pin definitions.

Pin#	Definition	Pin #	Definition
13	+3.3V	1	+3.3V
14	-12V	2	+3.3V
15	Ground	3	Ground
16	PS_ON	4	+5V
17	Ground	5	Ground
18	Ground	6	+5V
19	Ground	7	Ground
20	Res (NC)	8	PWR_OK
21	+5V	9	5VSB
22	+5V	10	+12V
23	+5V	11	+12V
24	Ground	12	+3.3V

Pins	Definition
1 through 4	Ground
5 through 8	+12V

(Required)

A. 24-Pin ATX Main PWR

B. 8-Pin PWR

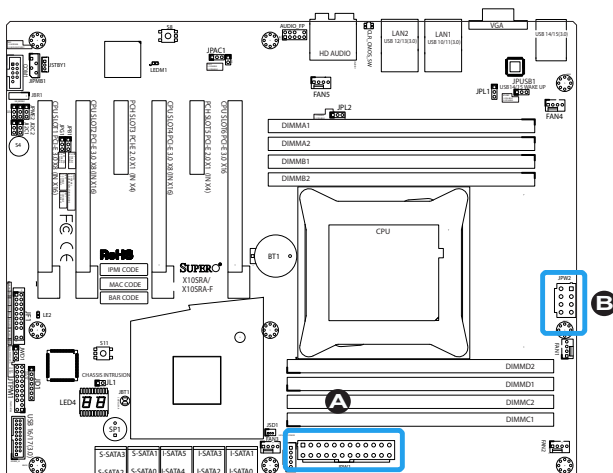

Fan Headers (Fan 1 ~ Fan 5)

The X10SRA/X10SRA-F has five fan headers (Fan 1~Fan 5). These fans are 4-pin fan headers. Although pins 1-3 of the fan headers are backward compatible with the traditional 3-pin fans, we recommend the use 4-pin fans to take advantage of the fan speed control. This allows the fan speeds to be automatically adjusted based on the motherboard temperature. Refer to the table on the right for pin definitions.

 **Note:** Fan 5 is equivalent to Fan A on the X10SRA motherboard.

Fan Header Pin Definitions	
Pin#	Definition
1	Ground (Black)
2	2.5A/+12V (Red)
3	Tachometer
4	PWM_Control

Chassis Intrusion Pin Definitions (JL1)	
Pin#	Definition
1	Intrusion Input
2	Ground

Chassis Intrusion (JL1)

A Chassis Intrusion header is located at JL1 on the motherboard. Attach the appropriate cable from the chassis to inform you of a chassis intrusion when the chassis is opened.

A. Fan 1 (CPU Fan)

B. Fan 2

C. Fan 3

D. Fan 4

E. Fan 5 (Fan A)

F. Chassis Intrusion

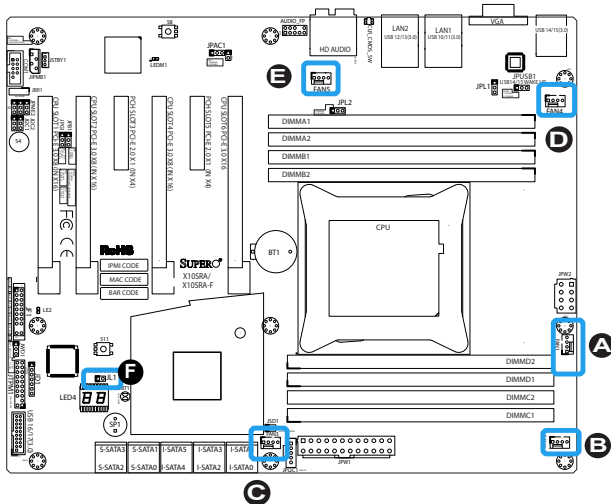

Internal Buzzer (SP1)

The Internal Buzzer (SP1) can be used to provide audible indications for various beep codes. See the table on the right for pin definitions.

Internal Buzzer Pin Definition		
Pin#	Definitions	
Pin 1	Pos. (+)	Beep In
Pin 2	Neg. (-)	Alarm Speaker

Speaker (JD1)

On the JD1 header, Pins 6~7 are used for internal/external speaker. Close pins 6~7 with a cap to use the onboard speaker. If you wish to use an external speaker, attach the external speaker cable to pins 6~7 instead. See the table on the right for pin definitions.

Speaker Connector Pin Definitions for Pins 6-7	
Pin Setting	Definition
Short	Internal Speaker
Attach Ext Speaker Cable	External Speaker

A. Internal Buzzer

B. Speaker Header

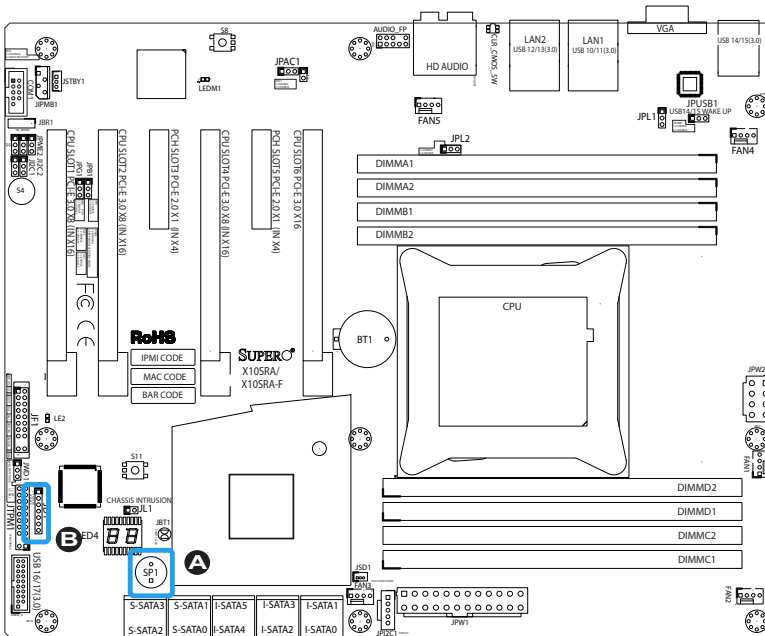

DOM PWR Connector (JSD1)

The Disk-On-Module (DOM) power connector, located at JSD1, provides 5V (Gen1/Gen) power to a solid state DOM storage device connected to one of the SATA ports. See the table on the right for pin definitions.

DOM PWR Pin Definitions	
Pin#	Definition
1	5V
2	Ground
3	Ground

Standby Power Header (STBY1)

The Standby Power header is located at STBY1 on the motherboard. See the table on the right for pin definitions.

Standby Power Pin Definitions	
Pin#	Definition
1	+5V Dual
2	Ground
3	Wake-up

System Management Bus (JIPMB1)

A System Management Bus header for the IPMI slot is located at IPMB. Connect the appropriate cable here to use the IPMB I2C connection on your system. Supported on the X10SRA-F only.

System Management Bus	
Pin#	Definition
1	Clock
2	Ground
3	Data
4	No Connection

A. DOM Power

B. STBY PWR

C. System Management Bus

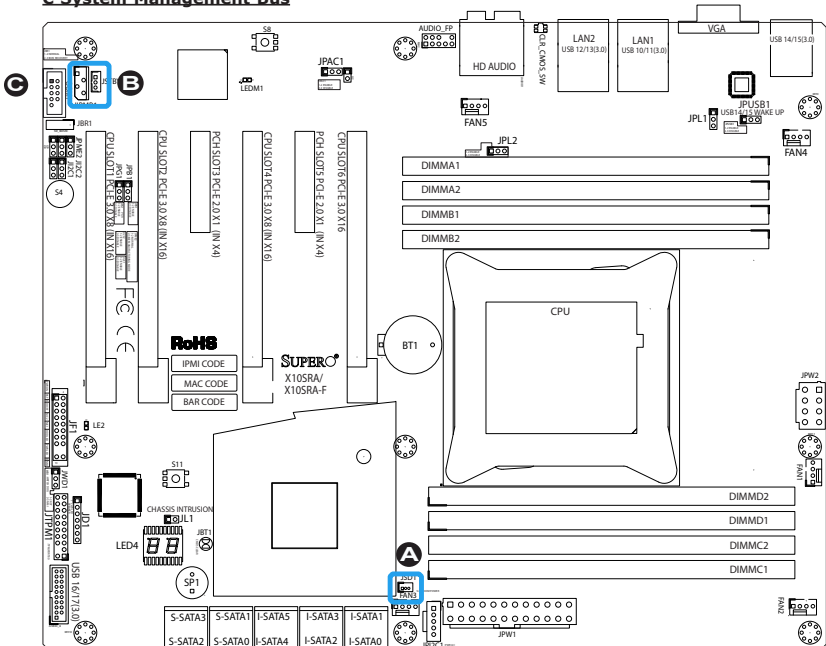

TPM Header (JTPM1)

This header is used to connect a Trusted Platform Module (TPM), which is available from a third-party vendor. A TPM is a security device that supports encryption and authentication in hard drives. It enables the motherboard to deny access if the TPM associated with the hard drive is not installed in the system. See the table on the right for pin definitions.

Trusted Platform Module Header Pin Definitions			
Pin #	Definition	Pin #	Definition
1	LCLK	2	GND
3	LFRAME	4	No Pin
5	LRESET	6	VCC5
7	LAD3	8	LAD2
9	VCC3	10	LAD1
11	LAD0	12	GND
13	SMBCLK	14	SMBDAT
15	SB3V	16	SERIRQ
17	GND	18	CLKRUN
19	LPCPD	20	LDRQ1

Power Supply I²C (JPI2C1)

The Power Supply I²C Connector, located at JPI2C, monitors the status of the power supply, fan and system temperature. See the table on the right for pin definitions.

PWR Supply I ² C Pin Definitions	
Pin#	Definition
1	Clock
2	Data
3	PWR Fail
4	Ground
5	3.3V

A. TPM Header

B. Power Supply I²C

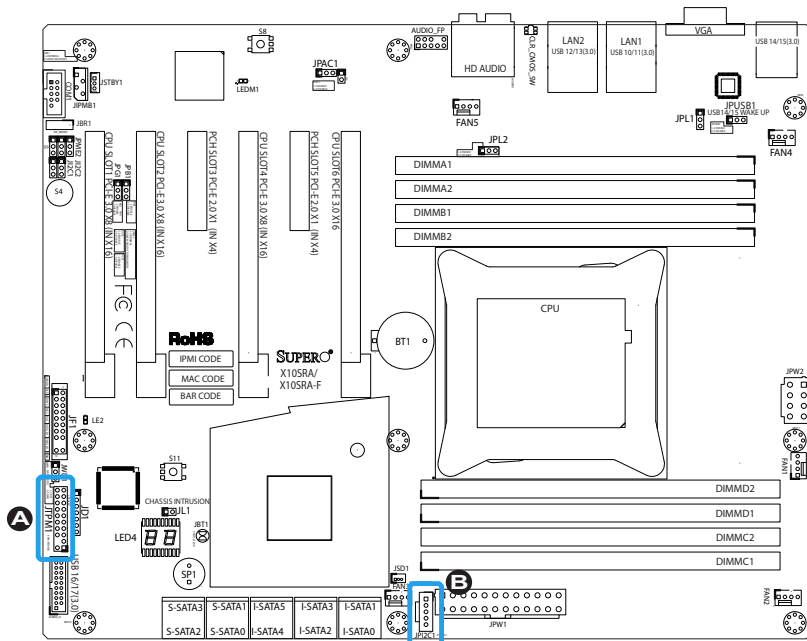

Front Panel Audio Header (AUDIO FP)

A 10-pin Audio header is supported on the motherboard. This header allows you to connect the motherboard to a front panel audio control panel, if needed. Connect an audio cable to the audio header to use this feature (not supplied). See the table at right for pin definitions for the header.

10-In Audio Pin Definitions	
Pin#	Signal
1	Microphone_Left
2	Audio_Ground
3	Microphone_Right
4	Audio_Detect
5	Line_2_Right
6	Ground
7	Jack_Detect
8	Key
9	Line_2_Left
10	Ground

A. AUDIO FP

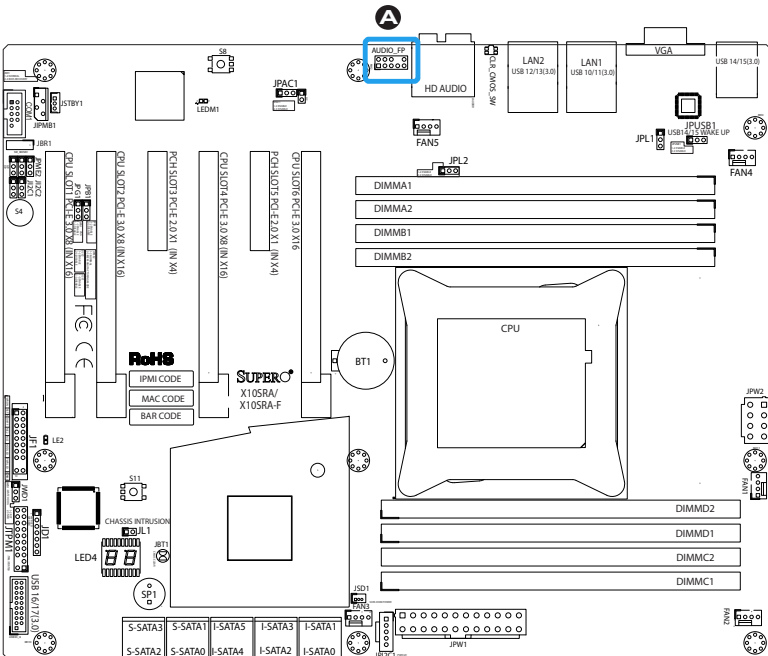

2-8 Jumper Settings

Explanation of Jumpers

To modify the operation of the motherboard, jumpers can be used to choose between optional settings. Jumpers create shorts between two pins to change the function of the connector. Pin 1 is identified with a square solder pad on the printed circuit board.



Note: On two pin jumpers, "Closed" means the jumper is on, and "Open" means the jumper is off the pins.

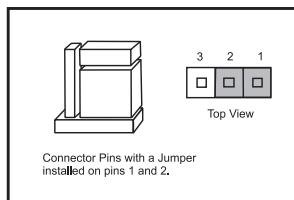
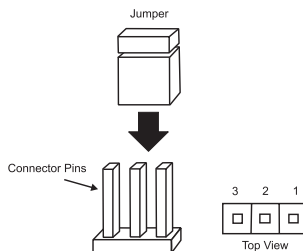

LAN1/LAN2 Enable/Disable

Jumpers JPL1/JPL2 enable or disable LAN ports 1/2 on the motherboard. See the table on the right for jumper settings. The default setting is enabled.

GLAN Enable Jumper Settings	
Pin#	Definition
1-2	Enabled (default)
2-3	Disabled

A. JPL1: LAN1 Enable

B. JPL2: LAN2 Enable

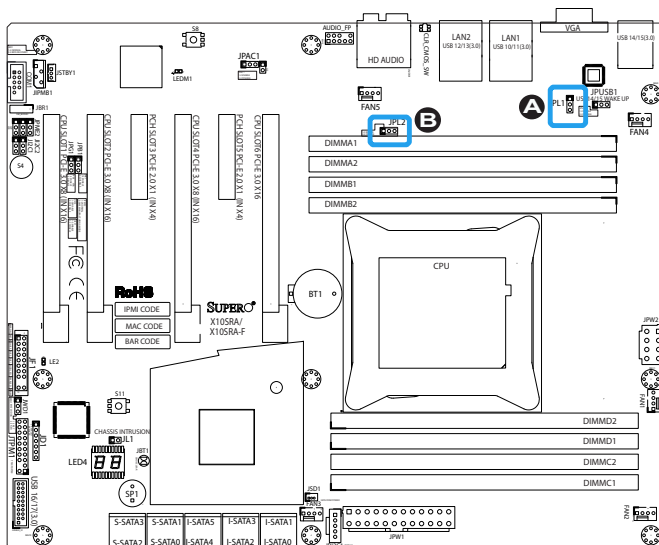

Clear CMOS (JBT1, CLR_CMOS_SW, S8)

JBT1, CLR_CMOS_SW and S8 are used to clear the saved system setup configuration stored in the CMOS chip. To clear the contents of the CMOS, completely shut down the system, remove the AC power cord and then short JBT1 with a jumper or use the push button switch on CLR_CMOS_SW or S8. Remove the jumper before powering on the system again. This will erase all user settings and revert everything to their factory-set defaults.

PCI Slot SMB Enable (I²C1/I²C2)

Use Jumpers I²C1/I²C2 to enable PCI SMB (System Management Bus) support to improve system management for the PCI slots. See the table on the right for jumper settings.

PCI Slot_SMB Enable Jumper Settings	
Jumper Setting	Definition
Short	Enabled
Open (Default)	Disabled

A. Clear CMOS

B. JI²C1

C. JI²C2

D. CLR_CMOS_SW

E. S8

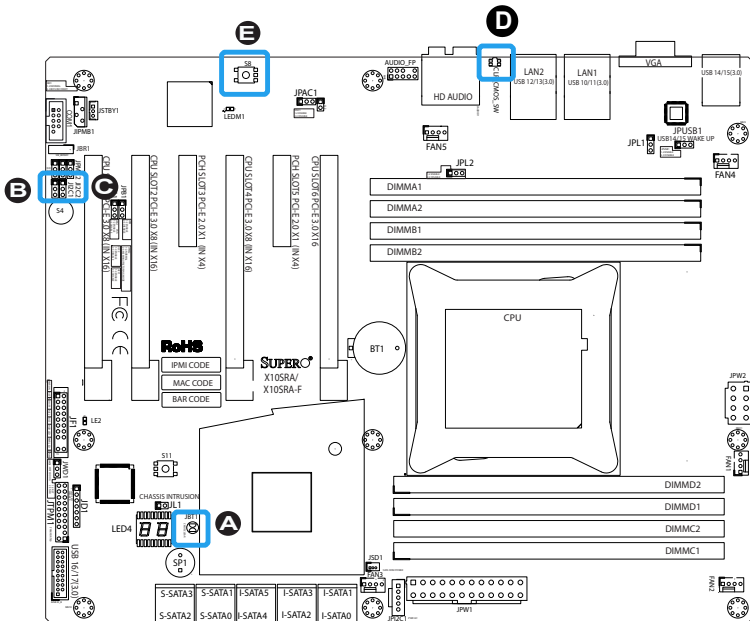

Audio Enable (JPAC1)

JPAC1 allows you to enable or disable the onboard audio support. The default position is on pins 1 and 2 to enable onboard audio connections. See the table on the right for jumper settings.

Audio Enable/Disable Jumper Settings	
Both Jumpers	Definition
Pins 1-2	Enabled
Pins 2-3	Disabled

Watch Dog Enable/Disable

Watch Dog (JWD1) is a system monitor that can reboot the system when a software application hangs. Close Pins 1-2 to reset the system if an application hangs. Close Pins 2-3 to generate a non-maskable interrupt signal for the application that hangs. See the table on the right for jumper settings. Watch Dog must also be enabled in the BIOS.

Watch Dog Jumper Settings	
Jumper Setting	Definition
Pins 1-2	Reset (default)
Pins 2-3	NMI
Open	Disabled

A. Audio Enable

B. Watch Dog Enable

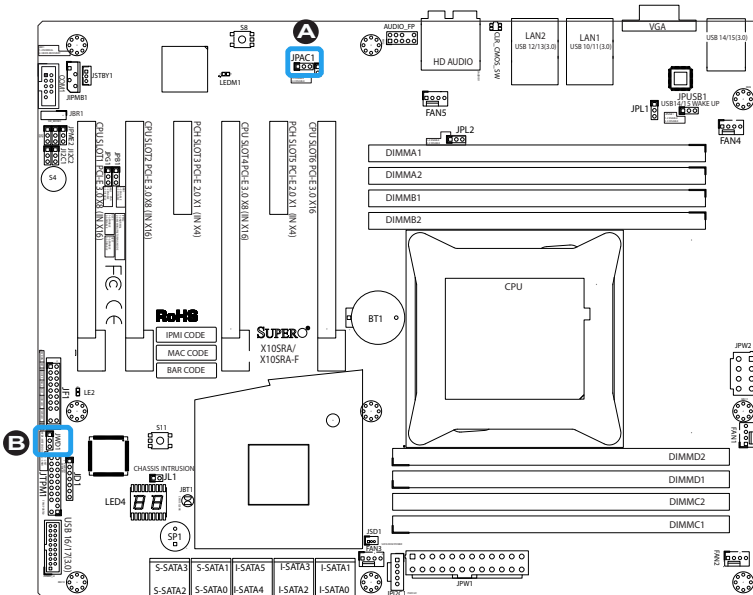

USB Wake-Up (JPUSB1)

Use jumper JPUSB1 to activate the "wake-up" function of the USB ports by pressing a key on an attached USB keyboard or clicking the USB mouse. This jumper is used together with a USB Wake-Up feature in the BIOS. Enable this jumper and the USB support in the BIOS to wake up your system via USB devices.



Note: Use JPUSB1 for the USB ports on the back panel.

USB Wake-Up Jumper Settings	
Jumper Setting	Definition
Pins 1-2	Enabled
Pins 2-3	Disabled (Default)

A. JPUSB1

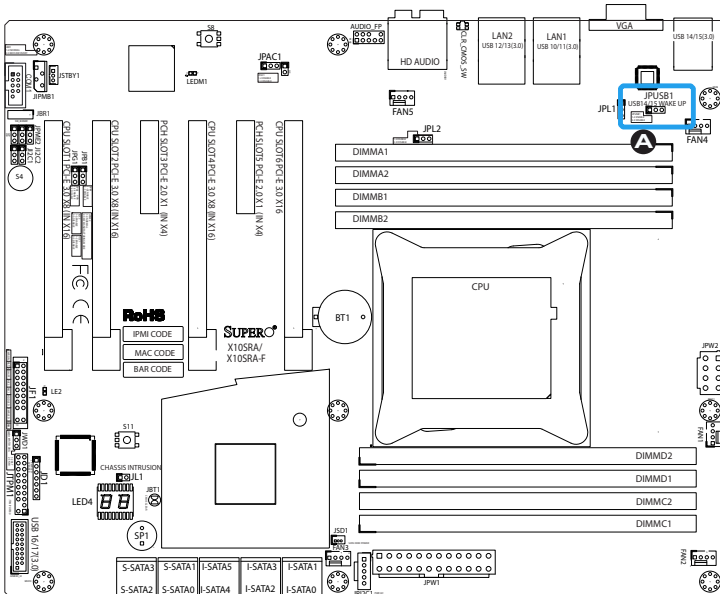

Manufacturing Mode (JPME2)

Close Pin 2 and Pin 3 of Jumper JPME2 to bypass SPI flash security and force the system to operate in Manufacturing Mode, allowing the user to flash the system firmware from a host server for system setting modifications. See the table on the right for jumper settings.

Manufacture Mode (JPME2) Jumper Settings	
Pin#	Definition
1-2	Normal (Default)
2-3	Manufacture Mode

VGA Enable/Disable (JPG1)

Close Pin 2 and Pin 3 of jumper JPG1 to disable the onboard graphics device. See the table on the right for jumper settings. Supported on the X10SRA-F only.

VGA Enable/Disable (JPG1) Jumper Settings	
Pin#	Definition
1-2	Normal (Default)
2-3	VGA Disabled

BMC Enable/Disable (JPB1)

Close Pin 2 and Pin 3 of jumper JPB1 to disable the onboard Baseboard Management Controller (BMC). See the table on the right for jumper settings. **Note:** this feature is for the X10SRA-F only.

- A. Manufacturing Mode**
- B. VGA Enable/Disable**
- C. BMC Enable/Disable**

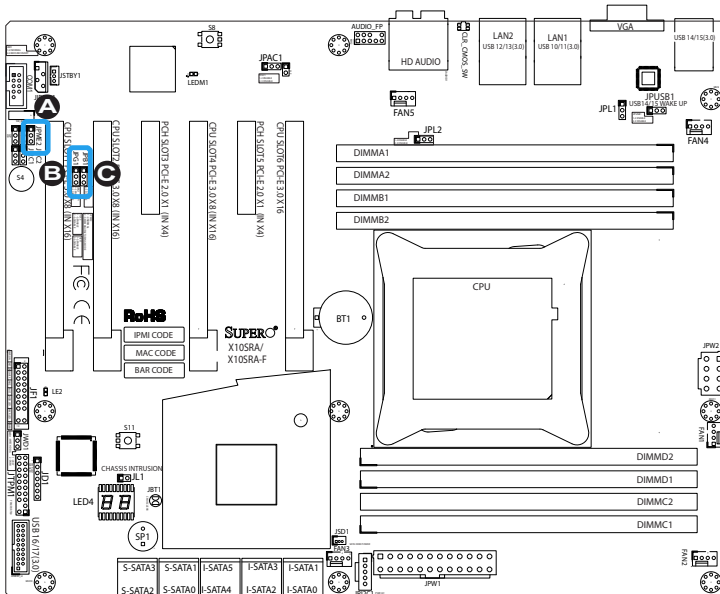

BIOS Recovery Switch (JBR1)

The BIOS Recovery Switch (JBR1) is used to enable or disable the BIOS Recovery feature of the motherboard. Slide the switch from the default position to begin the recovery process. See Appendix D for details.

BIOS Recovery (JBR1) Jumper Settings	
State	Definition
Off	Normal (Default)
On	Recover

Power Button (S4)

In addition to the soft power switch provided in JF1, your motherboard is equipped with a 'soft' power button on the motherboard. This switch works the same way as the soft power switch on JF1.

Manufacture Mode (JPME2) Jumper Settings	
Pin#	Definition
1-2	Normal (Default)
2-3	Manufacture Mode

BIOS Restore (S11)

When pressed, the BIOS Restore Button will look for, and load a file named 'SUPER.ROM' from an installed USB memory device, in any of the USB ports. It will then proceed to update the BIOS. Do NOT turn off the system when BIOS is updating.

A. BIOS Recovery

B. Power Button

C. BIOS Restore

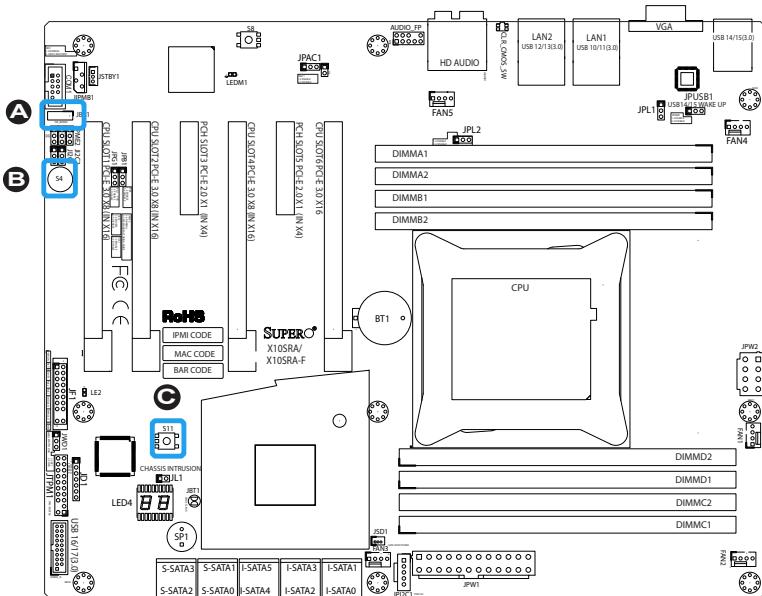

2-9 Onboard Indicators

LAN 1/LAN 2 LEDs

Two LAN ports (LAN 1/LAN 2) are located on the I/O backplane of the motherboard. Each Ethernet LAN port has two LEDs. The yellow LED indicates activity, while the Link LED may be green, amber, or off to indicate the speed of the connections. See the tables at right for more information.

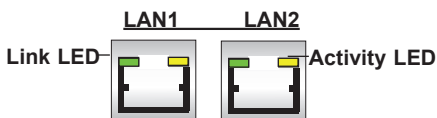

GLAN 1/2 Activity Indicator LED Settings		
Color	Status	Definition
Yellow	Flashing	Active

GLAN Ports 1/2 Link Indicator LED Settings	
LED Color	Definition
Off	No Connection/10 Mbps/100 Mbps
Amber	1 Gbps
Green	10 Gbps.

BMC Heartbeat (LED M1)

LED M1 is a status indicator for the on-board Baseboard Management Controller (BMC). See the table on the right for status display definitions. **Note:** this feature is for the X10SRA-F only.

BMC Heartbeat LED LED Status	
Status	Definition
Off	System Off
On, blinking	BMC running normal

A. LAN 1/2 LEDs

B. BMC Heartbeat

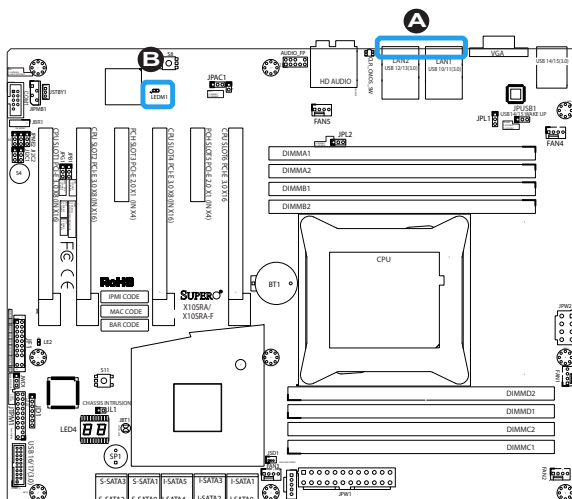

Power LED (LE2)

LED1 is a status LED to indicate that the motherboard is on and running. See the table on the right for status display definitions.

Power LED LED Status	
Status	Definition
Off	System Off
On	System On and Running

Status Display (LED4)

LED4 is made up of two alpha-numeric displays that will display a status or POST code, when the motherboard is powered on. Please download the following AMI publication for a complete list of POST codes:

http://www.ami.com/support/doc/ami_aptio_4.x_status_codes_pub.pdf

A. Power LED

B. Status Display

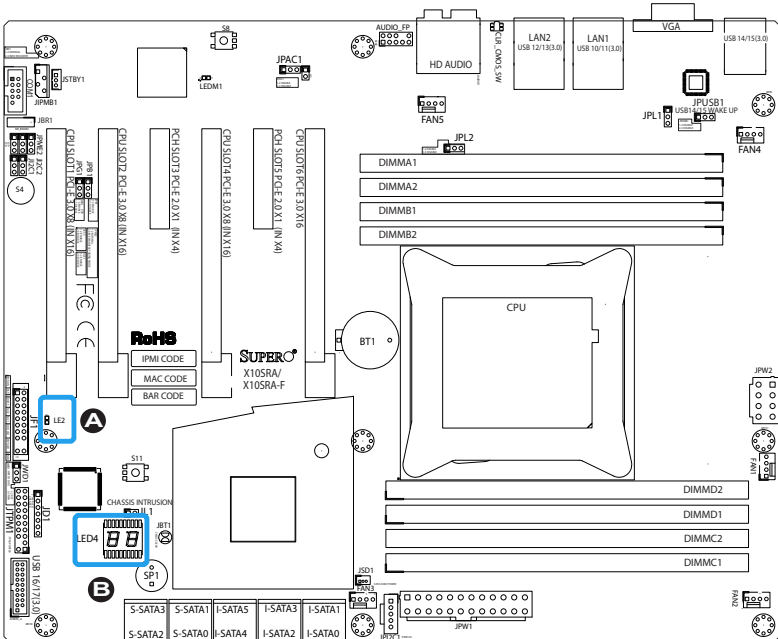

2-10 SATA Connections

SATA Connections (I-SATA0~5, S-SATA0~3)

Ten Serial ATA (SATA) 3.0 connectors (I-SATA0~5, S-SATA0~3) are supported on the board. All SATA 3.0 ports are supported by the Intel C612 PCH chip. RAID 0,1,5,10 are supported on all SATA ports. These high speed ports support transfer rates of up to 6Gb/s. See the table on the right for pin definitions.

SATA 2.0/3.0 Connectors Pin Definitions	
Pin#	Signal
1	Ground
2	SATA_TXP
3	SATA_TXN
4	Ground
5	SATA_RXN
6	SATA_RXP
7	Ground

Top

B. S-SATA3, S-SATA1, I-SATA5, I-SATA3, I-SATA1

Bottom

A. S-SATA2, S-SATA0, I-SATA4, I-SATA2, I-SATA0

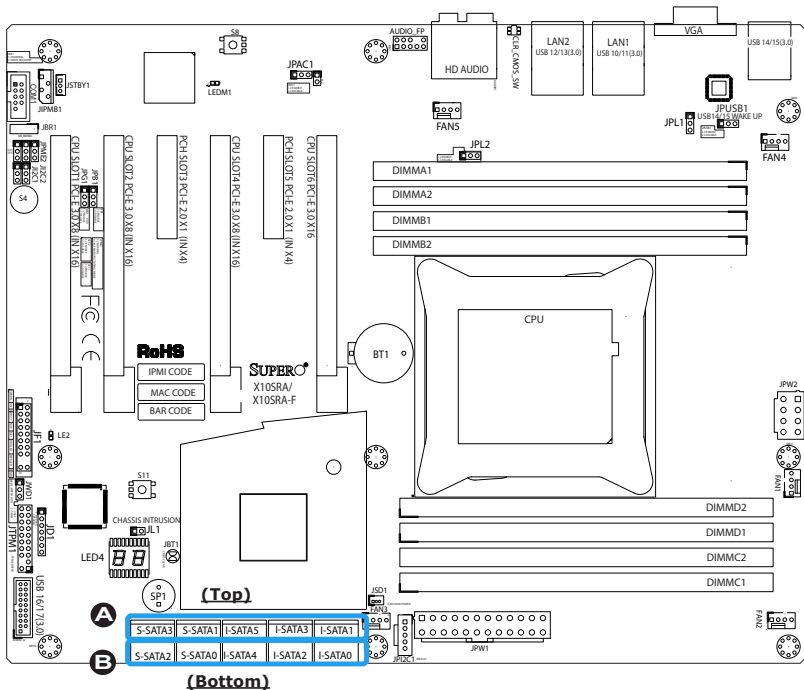

Chapter 3

Troubleshooting

3-1 Troubleshooting Procedures

Use the following procedures to troubleshoot your system. If you have followed all of the procedures below and still need assistance, refer to the 'Technical Support Procedures' and/or 'Returning Merchandise for Service' section(s) in this chapter. Always disconnect the AC power cord before adding, changing or installing any hardware components.

Before Power On

1. Make sure that the Standby PWR LED is not on. (**Note:** If it is on, the onboard power is on. Be sure to unplug the power cable before installing or removing the components.)
2. Make sure that there are no short circuits between the motherboard and chassis.
3. Disconnect all ribbon/wire cables from the motherboard, including those for the keyboard and mouse. Also, be sure to remove all add-on cards.
4. Install a CPU and heatsink (-be sure that it is fully seated) and then connect the chassis speaker and the power LED to the motherboard. Check all jumper settings as well.

No Power

1. Make sure that there are no short circuits between the motherboard and chassis.
2. Make sure that all jumpers are set to their default positions.
3. Check if the 115V/230V switch on the power supply is properly set.
4. Turn the power switch on and off to test the system.
5. The battery on your motherboard may be old. Check to make sure that it still supplies ~3VDC. If it does not, replace it with a new one.

No Video

1. If the power is on, but you have no video--in this case, you will need to remove all the add-on cards and cables first.
2. Use the speaker to determine if any beep codes exist. (Refer to Appendix A for details on beep codes.)
3. Remove all memory modules and turn on the system. (If the alarm is on, check the specifications of memory modules, reset the memory or try a different one.)

Memory Errors

1. Make sure that the DIMM modules are properly installed and fully seated in the slots.
2. You should be using unbuffered Non-ECC DDR4 memory recommended by the manufacturer. Also, it is recommended that you use the memory modules of the same type and speed for all DIMMs in the system. Do not use memory modules of different sizes, different speeds and different types on the same motherboard.
3. Check for bad DIMM modules or slots by swapping modules between slots to see if you can locate the faulty ones.
4. Check the switch of 115V/230V power supply.

When the System is Losing the Setup Configuration

1. Please be sure to use a high quality power supply. A poor quality power supply may cause the system to lose CMOS setup information. Refer to Section 1-5 for details on recommended power supplies.
2. The battery on your motherboard may be old. Check to verify that it still supplies ~3VDC. If it does not, replace it with a new one.
3. If the above steps do not fix the Setup Configuration problem, contact your vendor for repairs.

3-2 Technical Support Procedures

Before contacting Technical Support, please make sure that you have followed all the steps listed below. Also, Note that as a motherboard manufacturer, Supermicro does not sell directly to end users, so it is best to first check with your distributor or reseller for troubleshooting services. They should know of any possible problem(s) with the specific system configuration that was sold to you.

1. Please go through the 'Troubleshooting Procedures' and 'Frequently Asked Question' (FAQ) sections in this chapter or see the FAQs on our website (<http://www.supermicro.com/support/faqs/>) before contacting Technical Support.
2. BIOS upgrades can be downloaded from our website at (<http://www.supermicro.com/support/bios/>).



Note: Not all BIOS can be flashed. Some cannot be flashed; it depends on the boot block code of the BIOS.

3. If you've followed the instructions above to troubleshoot your system, and still cannot resolve the problem, then contact Supermicro's technical support and provide them with the following information:
 - Motherboard model and PCB revision number
 - BIOS release date/version (this can be seen on the initial display when your system first boots up)
 - System configuration
 - An example of a Technical Support form is on our website at (<http://www.supermicro.com/support/contact.cfm>).
4. Distributors: For immediate assistance, please have your account number ready when placing a call to our technical support department. We can be reached by e-mail at support@supermicro.com, by phone at: (408) 503-8000, option 2, or by fax at (408)503-8019.

3-3 Frequently Asked Questions

Question: What type of memory does my motherboard support?

Answer: The X10SRA/-F supports up to 512GB of DDR4 memory. See Section 2-4 for details.

Question: How do I update my BIOS?

Answer: We do NOT recommend that you upgrade your BIOS if you are not experiencing any problems with your system. Updated BIOS files are located on our website at <http://www.supermicro.com/support/bios/>. Please check our BIOS warning message and the information on how to update your BIOS on our web site. Select your motherboard model and download the BIOS ROM file to your computer. Also, check the current BIOS revision to make sure that it is newer than your BIOS before downloading. You may choose the zip file or the .exe file. If you choose the zipped BIOS file, please unzip the BIOS file onto a bootable device or a USB pen/thumb drive. To flash the BIOS, run the batch file named "ami.bat" with the new BIOS ROM file from your bootable device or USB pen/thumb drive. Use the following format:

```
F:\> ami.bat BIOS-ROM-filename.xxx <Enter>
```



Note: Always use the file named "ami.bat" to update the BIOS, and insert a space between "ami.bat" and the filename. The BIOS-ROM-filename will bear the motherboard name (i.e., X10SRA) and build version as the extension. For example, "X10SRA.115". When completed, your system will automatically reboot.

If you choose the .exe file, please run the .exe file under Windows to create the BIOS flash floppy disk. Insert the floppy disk into the system you wish to flash the BIOS. Then, boot the system to the floppy disk. The BIOS utility will automatically flash the BIOS without any prompts. Please note that this process may take a few minutes to complete. Do not be concerned if the screen is paused for a few minutes.

When the BIOS flashing screen is completed, the system will reboot and will show "Press F1 or F2". At this point, you will need to load the BIOS defaults. Press <F1> to go to the BIOS setup screen, and press <F9> to load the default settings. Next, press <F10> to save and exit. The system will then reboot.



Attention! Do not shut down or reset the system while updating the BIOS to prevent possible system boot failure!



Important: The SPI BIOS chip installed on this motherboard is not removable. To repair or replace a damaged BIOS chip, please send your motherboard to RMA at Supermicro for service.

Question: I think my BIOS is corrupted. How can I recover my BIOS?

Answer: Please see Appendix C-BIOS Recovery for detailed instructions.

3-4 Battery Removal and Installation

Battery Removal

To remove the onboard battery, follow the steps below:

1. Power off your system and unplug your power cable.
2. Locate the onboard battery as shown below.
3. Using a tool such as a pen or a small screwdriver, push the battery lock outwards to unlock it. Once unlocked, the battery will pop out from the holder.
4. Remove the battery.

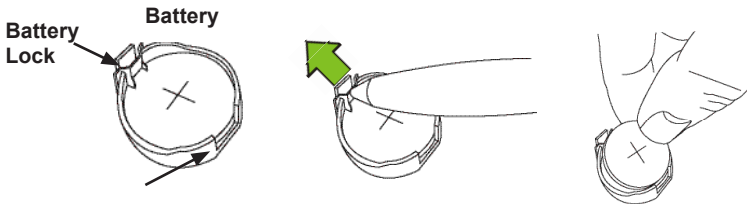

Proper Battery Disposal

- ! **Attention!** Please handle used batteries carefully. Do not damage the battery in any way; a damaged battery may release hazardous materials into the environment. Do not discard a used battery in the garbage or a public landfill. Please comply with the regulations set up by your local hazardous waste management agency to dispose of your used battery properly.

Battery Installation

1. To install an onboard battery, follow the steps 1& 2 above and continue below:
2. Identify the battery's polarity. The positive (+) side should be facing up.
3. Insert the battery into the battery holder and push it down until you hear a click to ensure that the battery is securely locked.

! **Attention!** When replacing a battery, be sure to only replace it with the same type.

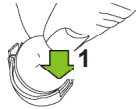
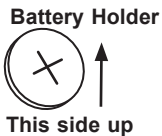

3-5 Returning Motherboard for Service

A receipt or copy of your invoice marked with the date of purchase is required before any warranty service will be rendered. You can obtain service by calling your vendor for a Returned Merchandise Authorization (RMA) number. For faster service, you may also obtain RMA authorizations online (<http://www.supermicro.com/support/rma/>). When you return the motherboard to the manufacturer, the RMA number should be prominently displayed on the outside of the shipping carton, and mailed prepaid or hand-carried. Shipping and handling charges will be applied for all orders that must be mailed when service is complete.

This warranty only covers normal consumer use and does not cover damages incurred in shipping or from failure due to the alteration, misuse, abuse or improper maintenance of products.

During the warranty period, contact your distributor first for any product problems.

Chapter 4

BIOS

4-1 Introduction

This chapter describes the AMI BIOS Setup Utility for the X10SRA/X10SRA-F motherboard. The ROM BIOS is stored in a Flash EEPROM and can be easily updated. This chapter describes the basic navigation of the AMI BIOS Setup Utility setup screens.



Note: For AMI BIOS Recovery, please refer to the UEFI BIOS Recovery Instructions in Appendix C.

Starting BIOS GUI Setup Utility

To enter the AMI BIOS GUI Setup Utility screens, press the <Delete> key while the system is booting up.



Note: In most cases, the <Delete> key is used to invoke the AMI BIOS setup screen.

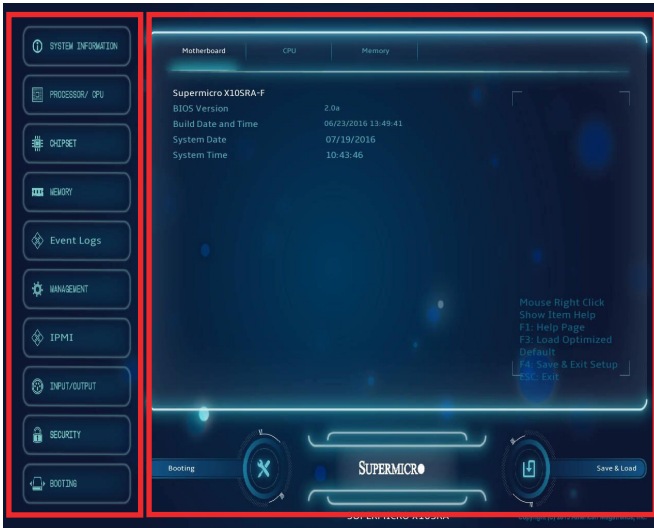

Each BIOS menu option is described in this manual. The Main BIOS Setup screen has two main areas. The left area is the Main Navigation, and the main area is for the Setup Section. Icons that do not respond when the mouse pointer is hovering on top are not configurable.

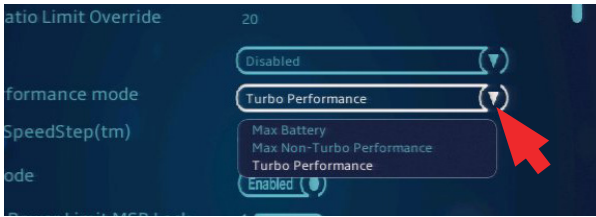

The AMI BIOS GUI Setup Utility uses a mouse pointer navigation system similar to standard graphical user interfaces. Hover and click an icon to select a section, click a down arrow to select from an options list.

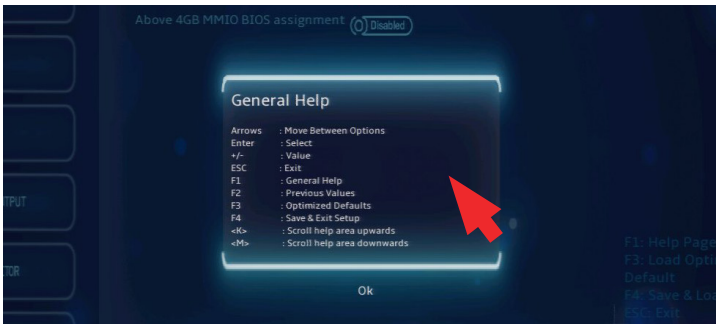

Except for the Home screen, you may press the <F1> on any screen under the Setup Section to see a list of Hot Keys that are available.

The keyboard's Escape key <ESC> cancels the current screen and will take you back to the previous screen.

How To Change the Configuration Data

The configuration data that determines the system parameters may be changed by entering the AMI BIOS GUI Setup utility. This Setup utility can be accessed by pressing at the appropriate time during system boot.



Note: For the purposes of this manual, options that are printed in **Bold** are default settings.

How to Start the Setup Utility

Normally, the only visible Power-On Self-Test (POST) routine is the memory test. As the memory is being tested, press the <Delete> key to

enter the main menu of the AMI BIOS GUI Setup Utility. From the Setup Home screen, you can access the other Setup Sections.

4-2 Saving and Loading

Save and Load



The Save and Load icon brings up a pop-up menu that enables the user to choose from different saving options at the end of the session:

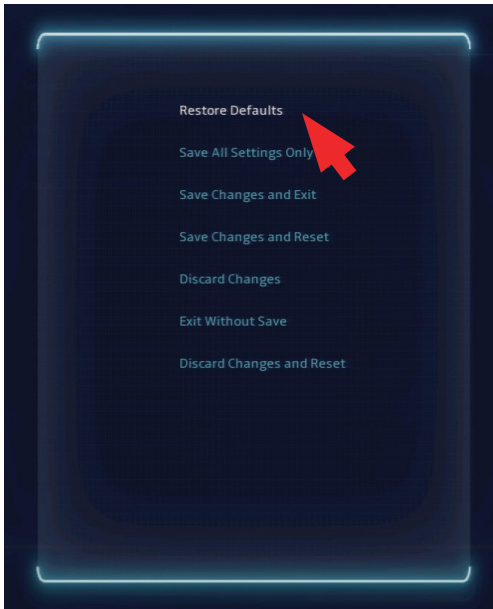

Restore Defaults

To set this feature, select Restore Defaults from the Save & Load menu and click <OK>. These are factory settings designed for maximum system stability.

Save All Settings Only

When you have completed the system configuration changes, select this option to save all changes made. This will not reset (reboot) the system and will not exit.

Save Changes and Exit

Select this option to save the current settings and exit Setup.

Save Changes and Reset

Select this option to save the current settings, exit Setup and reboot.

Discard Changes

Select this option discard any changes and return to Setup.

Exit without Save

Select this option to exit Setup without making any permanent changes to the system configuration.

Discard Changes and Reset

Select this option to discard all changes to setup and reboot.

Booting

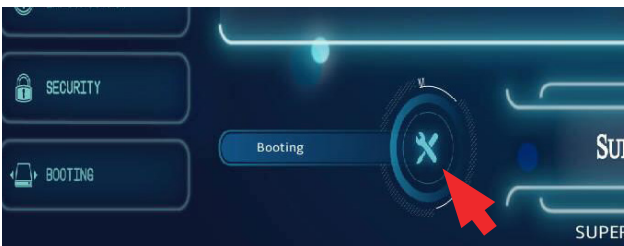

The Booting icon brings up a pop-up menu that enables the user to choose the booting mode, location and order of priority:



See Section 4-12 (Booting) for more information.

4-3 System Information

The System Information Screen displays the motherboard's configuration.

Motherboard

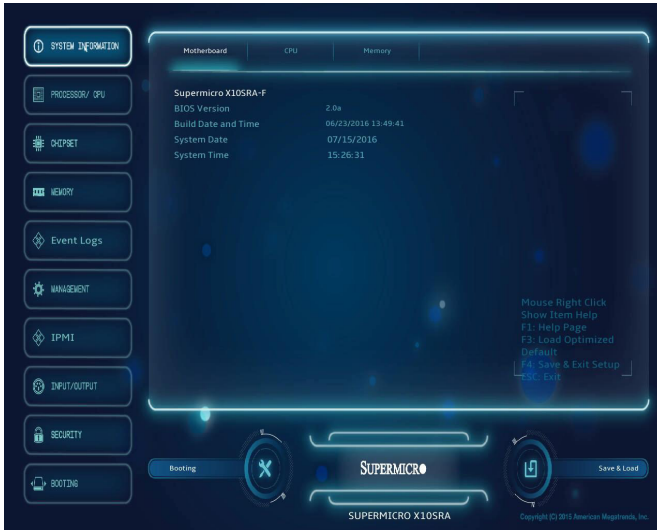

The following information are displayed in this section:

- **Motherboard Model Name** - X10SRA (-F).
- **BIOS Version** - this item displays the BIOS version number.
- **Build Date** - displays the BIOS build date.

System Date

This item sets and displays the system date. Click the up and down arrows to adjust the date.

System Time

This item sets and displays the system time. Click the up and down arrows to adjust the system time.

4-4 Processor (CPU)

Information

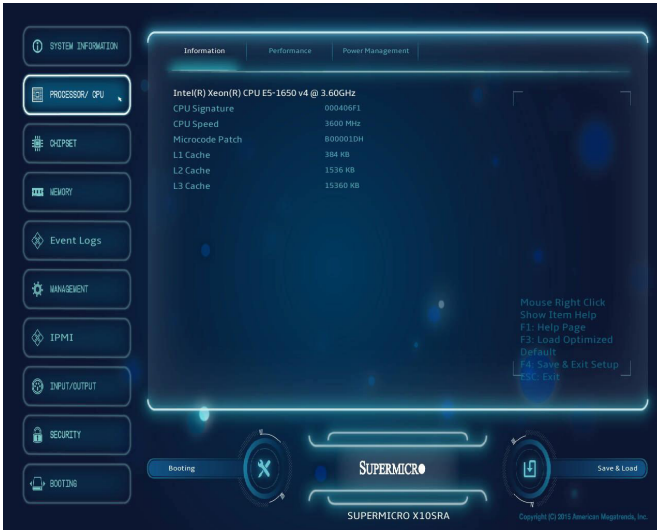

The following information are be displayed in this section:

- **Type and Speed of CPU** - indicates the brand, model name, model number of the CPU and it's rated clock speed.
- **CPU Signature** - displays the unique signature embedded in the CPU.
- **CPU Speed** - this item shows the current CPU speed.
- **Microcode Patch** - displays the CPU's microcode patch version.
- **L1 Cache** - displays the detected Level 1 cache size.
- **L2 Cache** - displays the detected Level 2 cache size.
- **L3 Cache** - displays the detected Level 3 cache size.

Performance

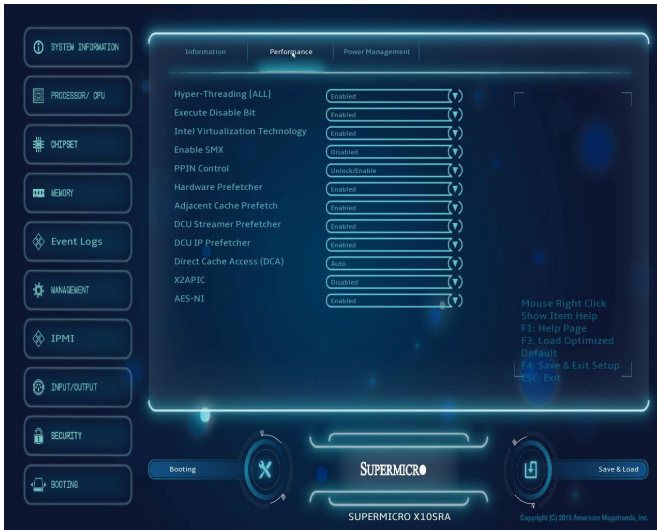

Hyper-threading [ALL]

Select Enabled to support Intel Hyper-threading Technology to enhance CPU performance. The options are **Enabled** and Disabled.

Execute-Disable Bit Capability (Available if supported by the OS & the CPU)

Select Enabled to enable the Execute-Disable Bit which will allow the processor to designate areas in the system memory where an application code can execute and where it cannot, thus preventing a worm or a virus from flooding illegal codes to overwhelm the processor or damage the system during an attack. The default is **Enabled**. (Refer to Intel and Microsoft Web sites for more information.)

Intel® Virtualization Technology

Select Enabled to support Intel Virtualization Technology, which will allow one platform to run multiple operating systems and applications in independent partitions, creating multiple "virtual" systems in one physical computer. The options are **Enabled** and Disabled.



Note: If a change is made to this setting, you will need to reboot the system for the change to take effect. Refer to Intel's website for detailed information.

Enable SMX

Select Enable to activate SMX speed technology. The options are **Enabled** and Disabled.

PPIN Control

Select Enable to unlock the PPIN control. The options are **Enabled** and Disabled.

Hardware Prefetcher (Available when supported by the CPU)

If set to Enabled, the hardware prefetcher will prefetch streams of data and instructions from the main memory to the L2 cache to improve CPU performance. The options are Disabled and **Enabled**.

Adjacent Cache Line Prefetch (Available when supported by the CPU)

The CPU prefetches the cache line for 64 bytes if this feature is set to Disabled. The CPU prefetches both cache lines for 128 bytes as comprised if this feature is set to **Enabled**.

DCU Streamer Prefetcher (Available when supported by the CPU)

Select Enabled to enable the DCU (Data Cache Unit) Streamer Prefetcher which will stream and prefetch data and send it to the Level 1 data cache to improve data processing and system performance. The options are Disabled and **Enabled**.

DCU IP Prefetcher (Available when supported by the CPU)

Select Enabled for DCU (Data Cache Unit) IP Prefetcher support, which will prefetch IP addresses to improve network connectivity and system performance. The options are Disabled and **Enabled**.

Direct Cache Access (DCA Support)

Select Enabled to use Intel's DCA (Direct Cache Access) Technology to improve data transfer efficiency. The options are **Enabled** and Disabled.

X2APIC

Select Enable to activate APIC (Advanced Programmable Interrupt Controller) support. The options are **Enabled** and Disabled.

AES-NI

Select Enable to use the Intel Advanced Encryption Standard (AES) New Instructions (NI) to ensure data security. The options are **Enabled** and Disabled.

Power Management

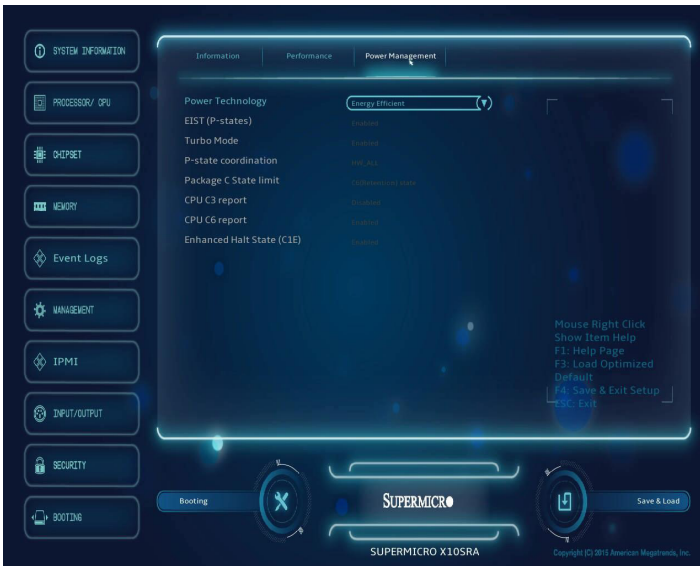

Power Technology

Select Energy Efficiency to support power-saving mode. Select Custom to customize system power settings. Select Disabled to disable power-saving settings. The options are Disable, **Energy Efficiency**, and Custom.

If the above is set to 'Custom' the following options are displayed:

EIST

EIST (Enhanced Intel SpeedStep Technology) allows the system to automatically adjust processor voltage and core frequency in an effort to reduce power consumption and heat dissipation. **Please refer to Intel's web site for detailed information.** The options are Disabled and **Enabled**.

Turbo Mode

This feature allows processor cores to run faster than the frequency recommended by the manufacturer. The options are Disabled and **Enabled**.

P-STATE Coordination

This feature selects the type of coordination for the P-State of the processor. P-State is a processor operational state that reduces the processor's voltage and frequency. This makes the processor more energy efficient, resulting in further energy gains. The options are HW_ALL, SW_ALL and SW-ANY.

Package C-State limit

This feature allows the user to set the limit on the C-State package register. The options are C0/C1 State, C2 State, C6 (Non Retention) State, and **C6 (Retention) State**.

CPU C3 Report

Select Enabled to allow the BIOS to report the CPU C3 State (ACPI C2) to the operating system. During the CPU C3 State, the CPU clock generator is turned off. The options are Enabled and **Disabled**.

CPU C6 Report

Select Enabled to allow the BIOS to report the CPU C6 State (ACPI C3) to the operating system. During the CPU C6 State, the power to all cache is turned off. The options are **Enabled** and Disabled.

Enhanced Halt State (C1E)

Select Enabled to use Enhanced Halt-State technology, which will significantly reduce the CPU's power consumption by reducing the CPU's clock cycle and voltage during a Halt-state. The options are Disable and **Enable**.

4-5 Chipset

Set all options for the Chipset in this section.

System Agent



The following will be displayed:

- **System Agent Bridge Name** - this displays the System Agent bridge name.
- **System Agent RC Version** - indicates the System Agent RC version.
- **VT-d Capability** - this item indicates whether VT-d is supported.

Enable IOAT

Select Enable to enable Intel I/OAT (I/O Acceleration Technology) support, which significantly reduces CPU overhead by leveraging CPU architectural improvements and freeing the system resource for other tasks. The options are **Enable** and Disable.

No Snoop

Select Enable to support no-snoop mode for each CB device. The options are **Disable** and Enable.

Relaxed Ordering

Select Enable to enable Relaxed Ordering support which will allow certain transactions to violate the strict-ordering rules of PCI bus for a transaction to be completed prior to other transactions that have already been enqueued. The options are **Disable** and Enable.

Intel VT for Directed I/O (VT-d)

Select Enabled to enable Intel Virtualization Technology support for Direct I/O VT-d by reporting the I/O device assignments to the Virtual Machine Manager (VMM) through the DMAR ACPI Tables. This feature offers fully-protected I/O resource-sharing across the Intel platforms, providing the user with greater reliability, security and availability in networking and data-sharing. The settings are **Enabled** and Disabled.

Interrupt Remapping

Select Enable for Interrupt Remapping support to enhance system performance. The options are **Enable** and Disable.

PCH I/O

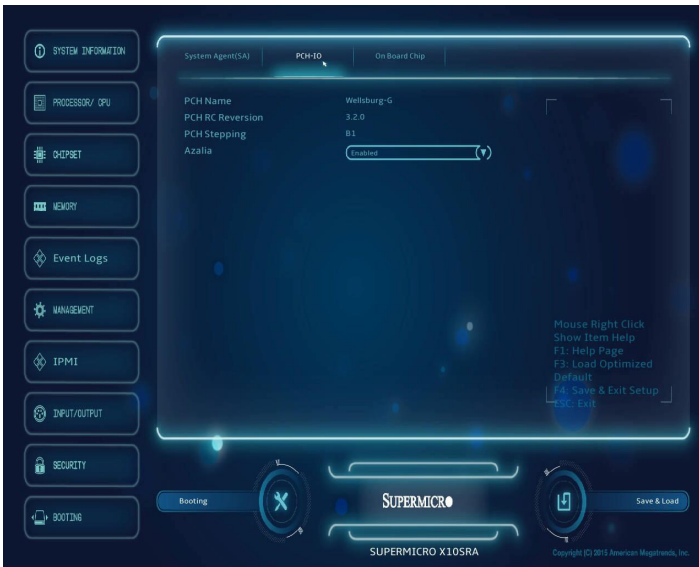

The following will be displayed:

- **PCH Name** - this displays the chipset name.
- **PCH RC Version** - indicates the PCH RC version.
- **PCH Stepping** - this item displays the PCH stepping..

Azalia (HD Audio)

This item controls the detection of the Azalia (HD Audio) device. The settings are Enabled and **Disabled**.

On Board Chip



Onboard USB Controller (USB 14/15)

This feature Enables or Disables the USB controller for USB ports 14/15. The options are Disabled and **Enabled**.

Onboard USB Controller (USB 16/17)

This feature Enables or Disables the USB controller for USB ports 16/17. The options are Disabled and **Enabled**.

USB Wake up from S5 Support (USB 14/15)

This feature Enables or Disables the ability of the system to 'wake-up' from the S5 sleep state through USB port 14/15. The options are Disabled and **Enabled**.

4-6 Memory

Set all options for the System Memory in this section.

Memory Information

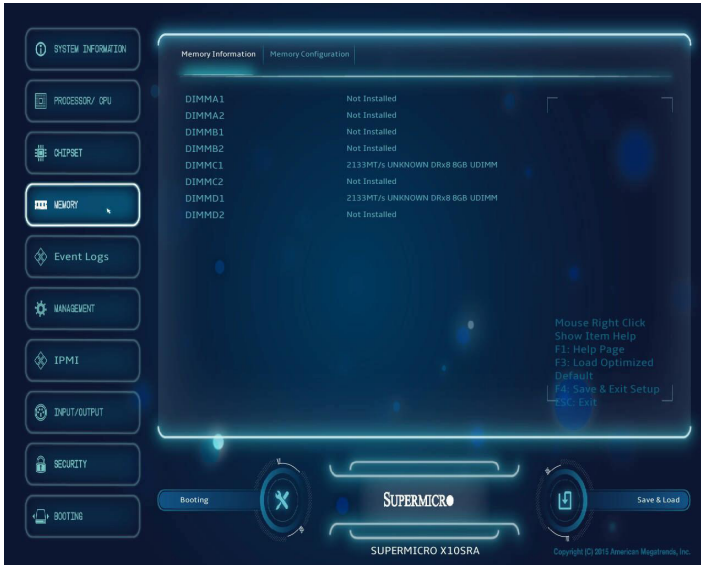

This item information on the memory modules installed on the motherboard.

- **DIMMA1~DIMMD2** - this item displays the type of memory that are detected for each memory slot.

Memory Configuration

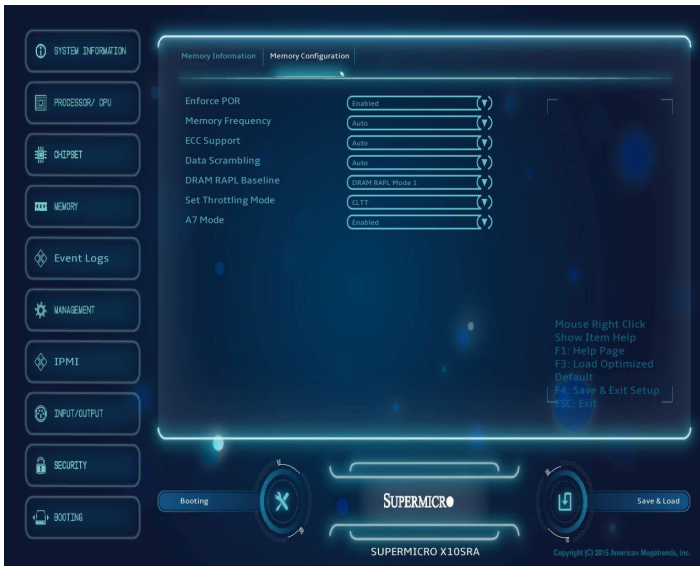

Enforce POR

Select Enable to enforce POR restrictions on DDR4 frequency and voltage programming. The options are **Enabled** and Disabled.

Memory Frequency

Use this feature to set the maximum memory frequency for onboard memory modules. The options are **Auto**, 1333, 1400, 1600, 1800, 1867, 2000, 2133, 2200, 2400, 2600, and 2667.

ECC Support

Select Enable to activate memory ECC (Error-Correction Code) . The options are **Enabled** and Disabled.

Data Scrambling

Select Enabled to enable data scrambling to enhance system performance and data integrity. The options are **Auto**, Disabled and Enabled.

DRAM RAPL Baseline

Use this feature to set the run-time power-limit baseline for DRAM modules. The options are Disable, DRAM RAPL Mode 0, and **DRAM RAPL Mode 1**.

Set Throttling Mode

Use this feature to activate Closed Loop Thermal Throttling (CLTT), which uses the DIMM memory temperature as input to make adjustments to the throttling based on variations in system's fan speed. The options are Disabled, and **CLTT**.

A7 Mode

Select Enabled to support the A7 (Addressing) mode to improve memory performance. The options are **Enable** and Disable.

4-7 Event Logs

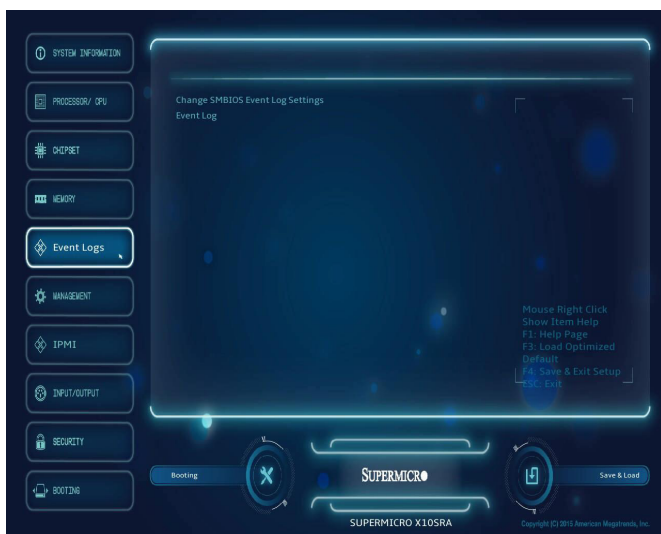

SMBIOS Event Log

Select Enabled to enable SMBIOS (System Management BIOS) Event Logging during system boot. The options are **Enabled** and Disabled.

Runtime Error Logging Support

Select Enabled to support Runtime Error Logging. The options are **Enabled** and Disabled. If this item is set to Enable, the following item will be available for configuration:

Memory Corrected Error Enabling (Available when the item above-Runtime Error Logging Support is set to Enable)

Select Enabled for the BIOS to correct a memory error if it is correctable. The options are **Enabled** and Disabled.

Memory Correctable Error Threshold

Use this item to enter the threshold value for correctable memory errors. The default setting is **10**.

PCI-Ex (PCI-Express) Error Enable

Select Yes for the BIOS to correct errors occurred in the PCI-E slots. The options are Yes and **No**.

Erasing Settings**Erase Event Log**

Select Enabled to erase all error events in the SMBIOS (System Management BIOS) log before an event logging is initialized at bootup. The options are **No** and Yes.

When Log is Full

Select Erase Immediately to immediately erase all errors in the SMBIOS event log when the event log is full. Select Do Nothing for the system to do nothing when the SMBIOS event log is full. The options are **Do Nothing** and Erase Immediately.

SMBIOS Event Log Standard Settings**Log System Boot Event**

Select Enabled to log system boot events. The options are **Disabled** and Enabled.

MECI (Multiple Event Count Increment)

Enter the increment value for the multiple event counter. Enter a number between 1 to 255. The default setting is **1**.

METW (Multiple Event Count Time Window)

This item is used to determine how long (in minutes) should the multiple event counter wait before generating a new event log. Enter a number between 0 to 99. The default setting is **60**.



Note: Please reboot the system for the changes to take effect.

4-8 Management

Set all options for the System Management feature in this section.

ACPI Settings

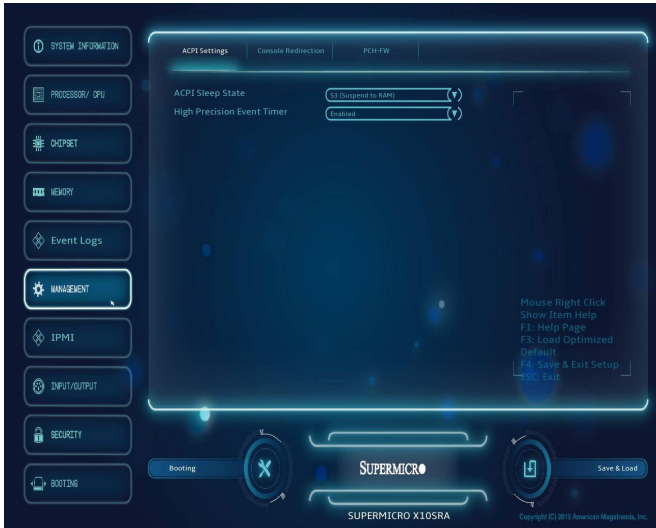

ACPI Sleep State

This feature selects the ACPI Sleep State that the system will enter into when the suspend button is activated. The options are Suspend Disabled, and **S3 (Suspend to RAM)**.

High Precision Event Timer

Select Enabled to activate the High Precision Event Timer (HPET) that produces periodic interrupts at a much higher frequency than a Real-time Clock (RTC) does in synchronizing multimedia streams, providing smooth playback and reducing the dependency on other timestamp calculation devices, such as an x86 RDTSC Instruction embedded in the CPU. The High Performance Event Timer is used to replace the 8254 Programmable Interval Timer. The options are **Enabled** and Disabled.

Console Redirection

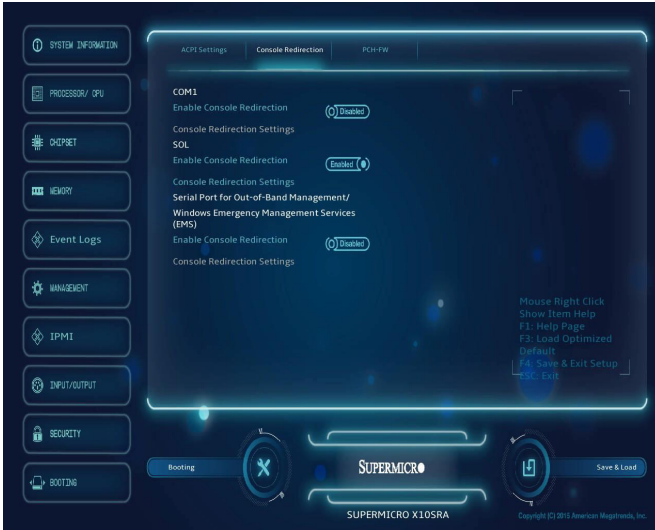

COM 1

Enable Console Redirection

Select Enabled to enable COM Port 1 Console Redirection, which will allow a client machine to be connected to a host machine at a remote site for networking. The options are **Disabled** and Enabled.

**If the item above set to Enabled, the following items will become available for configuration:*

Console Redirection Settings

Terminal Type

This feature allows the user to select the target terminal emulation type for Console Redirection. Select VT100 to use the ASCII Character set. Select VT100+ to add color and function key support. Select ANSI to use the Extended ASCII Character Set. Select VT-UTF8 to use UTF8 encoding to map Unicode characters into one or more bytes. The options are ANSI, VT100, **VT100+**, and VT-UTF8.

Bits Per second

Use this item to set the transmission speed for a serial port used in Console Redirection. Make sure that the same speed is used in the host computer and the client computer. A lower transmission speed may be required for long and busy lines. The options are 9600, 19200, 38400, 57600 and **115200** (bits per second).

Data Bits

Use this feature to set the data transmission size for Console Redirection. The options are 7 (Bits) and **8 (Bits)**.

Parity

A parity bit can be sent along with regular data bits to detect data transmission errors. Select Even if the parity bit is set to 0, and the number of 1's in data bits is even. Select Odd if the parity bit is set to 0, and the number of 1's in data bits is odd. Select None if you do not want to send a parity bit with your data bits in transmission. Select Mark to add a mark as a parity bit to be sent along with the data bits. Select Space to add a Space as a parity bit to be sent with your data bits. The options are **None**, Even, Odd, Mark and Space.

Stop Bits

A stop bit indicates the end of a serial data packet. Select 1 Stop Bit for standard serial data communication. Select 2 Stop Bits if slower devices are used. The options are **1** and 2.

Flow Control

Use this item to set the flow control for Console Redirection to prevent data loss caused by buffer overflow. Send a "Stop" signal to stop sending data when the receiving buffer is full. Send a "Start" signal to start sending data when the receiving buffer is empty. The options are **None** and Hardware RTS/CTS.

VT-UTF8 Combo Key Support

Select Enabled to enable VT-UTF8 Combination Key support for ANSI/VT100 terminals. The options are **Enabled** and Disabled.

Recorder Mode

Select Enabled to capture the data displayed on a terminal and send it as text messages to a remote server. The options are Enabled and **Disabled**.

Resolution 100x31

Select Enabled for extended-terminal resolution support. The options are **Enabled** and Disabled.

Legacy OS Redirection Resolution

Use this item to select the number of rows and columns used in Console Redirection for legacy OS support. The options are **80x24** and 80x25.

Putty KeyPad

This feature selects Function Keys and KeyPad settings for Putty, which is a terminal emulator designed for the Windows OS. The options are **VT100**, LINUX, XTERMR6, SCO, ESCN, and VT400.

Redirection After BIOS Post

Use this feature to enable or disable legacy Console Redirection after BIOS POST. When the option-Bootloader is selected, legacy Console Redirection is disabled before booting the OS. When the option- Always Enable is selected, legacy Console Redirection remains enabled upon OS bootup. The options are **Always Enable** and Bootloader.

SOL (X10SRA-F only)**Enable Console Redirection**

Select Enabled to use the SOL port for Console Redirection. The options are **Enabled** and Disabled.

**If the item above set to Enabled, the following items will become available for user's configuration:*

Console Redirection Settings**Terminal Type**

Use this feature to select the target terminal emulation type for Console Redirection. Select VT100 to use the ASCII Character set. Select VT100+ to add color and function key support. Select ANSI to use the Extended ASCII Character Set. Select VT-UTF8 to use UTF8 encoding

to map Unicode characters into one or more bytes. The options are ANSI, VT100, **VT100+**, and VT-UTF8.

Bits Per second

Use this feature to set the transmission speed for a serial port used in Console Redirection. Make sure that the same speed is used in the host computer and the client computer. A lower transmission speed may be required for long and busy lines. The options are 9600, 19200, 38400, 57600 and **115200** (bits per second).

Data Bits

Use this feature to set the data transmission size for Console Redirection. The options are 7 (Bits) and **8 (Bits)**.

Parity

A parity bit can be sent along with regular data bits to detect data transmission errors. Select Even if the parity bit is set to 0, and the number of 1's in data bits is even. Select Odd if the parity bit is set to 0, and the number of 1's in data bits is odd. Select None if you do not want to send a parity bit with your data bits in transmission. Select Mark to add a mark as a parity bit to be sent along with the data bits. Select Space to add a Space as a parity bit to be sent with your data bits. The options are **None**, Even, Odd, Mark and Space.

Stop Bits

A stop bit indicates the end of a serial data packet. Select 1 Stop Bit for standard serial data communication. Select 2 Stop Bits if slower devices are used. The options are **1** and 2.

Flow Control

Use this feature to set the flow control for Console Redirection to prevent data loss caused by buffer overflow. Send a "Stop" signal to stop sending data when the receiving buffer is full. Send a "Start" signal to start data-sending when the receiving buffer is empty. The options are **None** and Hardware RTS/CTS.

VT-UTF8 Combo Key Support

Select Enabled to enable VT-UTF8 Combination Key support for ANSI/VT100 terminals. The options are **Enabled** and Disabled.

Recorder Mode

Select Enabled to capture the data displayed on a terminal and send it as text messages to a remote server. The options are **Disabled** and Enabled.

Resolution 100x31

Select Enabled for extended-terminal resolution support. The options are Disabled and **Enabled**.

Legacy OS Redirection Resolution

Use this feature to select the number of rows and columns used in Console Redirection for legacy OS support. The options are **80x24** and 80x25.

Putty KeyPad

This feature selects Function Keys and KeyPad settings for Putty, which is a terminal emulator designed for the Windows OS. The options are **VT100**, LINUX, XTERMR6, SCO, ESCN, and VT400.

Redirection After BIOS Post

Use this feature to enable or disable legacy Console Redirection after BIOS POST (Power-On Self-Test). When this feature is set to Bootloader, legacy Console Redirection is disabled before booting the OS. When this feature is set to Always Enable, legacy Console Redirection remains enabled upon OS boot. The options are **Always Enable** and Bootloader.

Serial Port for Out-of-Band Management/Windows Emergency Management Services (EMS)

The submenu allows the user to configure Console Redirection settings to support Out-of-Band Serial Port management.

Enable Console Redirection

Select Enabled to use a COM port selected by the user for EMS Console Redirection. The options are Enabled and **Disabled**.

**If the item above set to Enabled, the following items will become available for user's configuration:*

Console Redirection Settings

Out-of-Band Management Port

The feature selects a serial port in a client server to be used by the Windows Emergency Management Services (EMS) to communicate with a remote host server. The options are **COM1 (Console Redirection)** and SOL (Console Redirection, X10SRA-F only).

Terminal Type

Use this feature to select the target terminal emulation type for Console Redirection. Select VT100 to use the ASCII character set. Select VT100+ to add color and function key support. Select ANSI to use the extended ASCII character set. Select VT-UTF8 to use UTF8 encoding to map Unicode characters into one or more bytes. The options are ANSI, VT100, VT100+, and **VT-UTF8**.

Bits Per Second

This item sets the transmission speed for a serial port used in Console Redirection. Make sure that the same speed is used in both host computer and the client computer. A lower transmission speed may be required for long and busy lines. The options are 9600, 19200, 57600, and **115200** (bits per second).

Flow Control

Use this item to set the flow control for Console Redirection to prevent data loss caused by buffer overflow. Send a "Stop" signal to stop data-sending when the receiving buffer is full. Send a "Start" signal to start data-sending when the receiving buffer is empty. The options are **None**, Hardware RTS/CTS, and Software Xon/Xoff.

The setting for each these features is displayed:

Data Bits, Parity, Stop Bits

PCH-FW (Firmware)

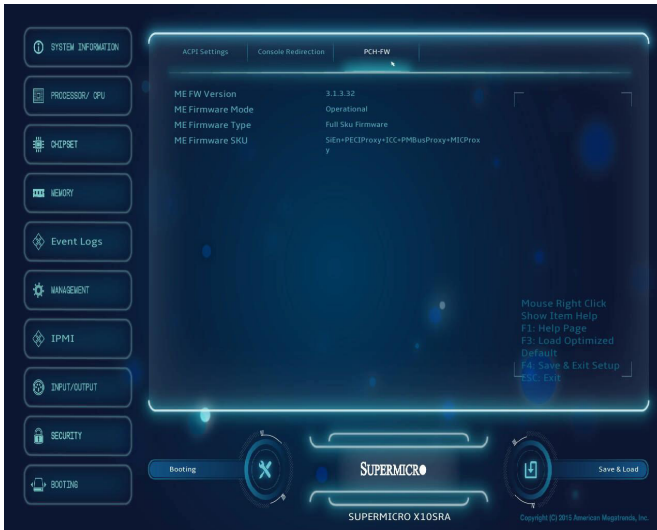

The following information for the PCH Firmware.

- **ME FW Version** - displays the Management Engine version number.
- **ME Firmware Mode** - displays the Management Engine mode.
- **ME Firmware Type** - displays the Management Engine firmware type.
- **ME Firmware SKU** - displays the Management Engine SKU size.

4-9 IPMI

Use this feature to configure Intelligent Platform Management Interface (IPMI) settings. This is supported on the X10SRA-F only.

IPMI



The following will be displayed:

- **IPMI Firmware Revision** - This item indicates the IPMI firmware revision used in your system.
- **IPMI Status** - This item indicates the status of the IPMI firmware installed in your system.

System Event Log

SEL Components

Select Enabled to enable all system event logging support at bootup. The options are **Enabled** and Disabled.

Erasing Settings

Erase SEL

Select Yes, On next reset to erase all system event logs upon next system reboot. Select Yes, On every reset to erase all system event logs upon each system reboot. Select No to keep all system event logs after each system reboot. The options are **No**, Yes, On next reset, and Yes, On every reset.

When SEL is Full

This feature allows the user to determine what the BIOS should do when the system event log is full. Select Erase Immediately to erase all events in the log when the system event log is full. The options are **Do Nothing** and Erase Immediately.

Note: After making changes on a setting, be sure to reboot the system for the changes to take effect.

BMC Network Configuration

The following items will be displayed:

BMC Network Configuration

- **IPMI LAN Selection** - IPMI LAN Selection status
- **IPMI Network Link Status** - Connection status

Update IPMI LAN Configuration

Select Yes for the system BIOS to automatically reset the following IPMI settings at next system boot. The options are Yes and **No**.

Configuration Address Source (Available when the item above - Update IPMI LAN Configuration is set to Yes)

Use this item to select the IP address source for this computer. If Static is selected, you will need to know the IP address of this computer and enter it to the system manually in the field. If DHCP is selected, AMI BIOS will search for a DHCP (Dynamic Host Configuration Protocol) server attached to the network and request the next available IP address for this computer. The options are **DHCP** Unspecified, and Static.

Station IP Address

This item displays the Station IP address for this computer. This should be in decimal and in dotted quad form (i.e., 192.168.10.253).

Subnet Mask

This item displays the sub-network that this computer belongs to. The value of each three-digit number is separated by dots and it should not exceed 255.

Station MAC Address

This item displays the Station MAC address for this computer. Mac addresses are 6 two-digit hexadecimal numbers.

Gateway IP Address

This item displays the Gateway IP address for this computer. This should be in decimal and in dotted quad form (i.e., 192.168.10.253).

When you have completed the system configuration changes, select this option to save the changes and reboot the computer so that the new system configuration settings can take effect. Select Save Changes and Exit, and press <Enter>. When the dialog box appears, asking you if you want to exit the BIOS setup without saving, click **Yes** to quit BIOS without saving the changes, or click No to quit the BIOS and save changes.

4-10 Input/Output

Set all options for the I/O in this section.

SATA



SATA Controller

This item enables or disables the onboard SATA controller supported by the Intel PCH chip. The options are **Enabled** and Disabled.

Configure SATA as

Select IDE to configure a SATA drive specified by the user as an IDE drive. Select AHCI to configure a SATA drive specified by the user as an AHCI drive. Select RAID to configure a SATA drive specified by the user as a RAID drive. The options are IDE, **AHCI**, and RAID.

**If the item above "Configure SATA as" is set to AHCI, the following items will display:*

Support Aggressive Link Power Management

When this item is set to Enabled, the SATA AHCI controller manages the power usage of the SATA link. The controller will put the link to a low power state when the I/O is inactive for an extended period of time, and the power state will return to normal when the I/O becomes active. The options are **Enabled** and Disabled.

SATA Port 0 ~ SATA Port 5

This item displays the information detected on the installed SATA drive on the particular SATA port.

- Model number of drive and capacity

Port 0 ~ Port 5 Spin Up Device

On an edge detect from 0 to 1, set this item to allow the PCH to initialize the device. The options are Enabled and **Disabled**.

Port 0 ~ Port 5 SATA Device Type

Use this item to specify if the SATA port specified by the user should be connected to a Solid State drive or a Hard Disk Drive. The options are Hard Disk Drive and Solid State Drive.

**If the item above "Configure SATA as" is set to IDE, the following items will display:*

Serial ATA Port 0~ Port 5

This item displays the information detected on the installed SATA drive on the particular SATA port.

- Model number of drive and capacity

Port 0 ~ Port 5 SATA Device Type

Use this item to specify if the SATA port specified by the user should be connected to a Solid State drive or a Hard Disk Drive. The options are Hard Disk Drive and Solid State Drive.

**If the item above "Configure SATA as" is set to RAID, the following items will display:*

Support Aggressive Link Power Management

When this item is set to Enabled, the SATA AHCI controller manages the power usage of the SATA link. The controller will put the link to a low power state when the I/O is inactive for an extended period of time, and the power state will return to normal when the I/O becomes active. The options are **Enabled** and Disabled.

Load EFI Driver for RAID

This option enables the system to load the RAID EFI driver during system boot. Select Enabled to load the EFI driver, select **Disabled** to load the legacy driver for system boot.

Serial ATA Port 0~ Port 5

This item displays the information detected on the installed SATA drives on the particular SATA port.

- Model number of drive and capacity

Port 0 ~ Port 5 Spin Up Device

On an edge detect from 0 to 1, set this item to allow the PCH to start a COMRESET initialization to the device. The options are Enabled and **Disabled**.

Port 0 ~ Port 5 SATA Device Type

Use this item to specify if the SATA port specified by the user should be connected to a Solid State drive or a Hard Disk Drive. The options are Hard Disk Drive and Solid State Drive.

sSATA



sSATA Controller

This item enables or disables the onboard SATA controller supported by the Intel PCH-sSATA controller. The options are **Enabled** and Disabled.

Configure sSATA as

Select IDE to configure an sSATA drive specified by the user as an IDE drive. Select AHCI to configure an sSATA drive specified by the user as an AHCI drive. The options are IDE, **AHCI** and RAID.

**If the item above "Configure sSATA as" is set to AHCI, the following items will display:*

Support Aggressive Link Power Management

When this item is set to Enabled, the sSATA AHCI controller manages the power usage of the sSATA link. The controller will put the link to a low power state when the I/O is inactive for an extended period of time, and the power state will return to normal when the I/O becomes active. The options are **Enabled** and Disabled.

sSATA Port 0~ Port 3

This item displays the information detected on the installed on the sSATA port. specified by the user.

- Model number of drive and capacity
- Software Preserve Support

sSATA Port 0~ Port 3

Select Enabled to enable an sSATA port specified by the user. The options are Disabled and Enabled.

sSATA Port 0 ~ Port 3 Spin Up Device

On an edge detect from 0 to 1, set this item to allow the PCH to start a COMRESET initialization to the device. The options are Enabled and **Disabled**.

Port 0 ~ Port 3 sSATA Device Type

Use this item to specify if the sSATA port specified by the user should be connected to a Solid State drive or a Hard Disk Drive. The options are Hard Disk Drive and Solid State Drive.

**If the item above "Configure sSATA as" is set to IDE, the following items will display:*

sSATA Port 0~ Port 3

This item indicates that an sSATA port specified by the user is installed (present) or not.

Port 0 ~ Port 3 sSATA Device Type (Available when a SATA port is detected)

Use this item to specify if the sSATA port specified by the user should be connected to a Solid State drive or a Hard Disk Drive. The options are Hard Disk Drive and Solid State Drive.

**If the item above "Configure sSATA as" is set to RAID, the following items will display:*

Support Aggressive Link Power Management

When this item is set to Enabled, the SATA AHCI controller manages the power usage of the SATA link. The controller will put the link to a low power state when the I/O is inactive for an extended period of time, and the power state will return to normal when the I/O becomes active. The options are **Enabled** and Disabled.

Load EFI Driver for RAID

This option enables the system to load the RAID EFI driver during system boot. Select Enabled to load the EFI driver, select **Disabled** to load the legacy driver for system boot.

Serial ATA Port 0~ Port 3

This item displays the information detected on the installed SATA drives on the particular SATA port.

- Model number of drive and capacity

Port 0 ~ Port 3 Spin Up Device

On an edge detect from 0 to 1, set this item to allow the PCH to start a COMRESET initialization to the device. The options are Enabled and **Disabled**.

Port 0 ~ Port 3 SATA Device Type

Use this item to specify if the SATA port specified by the user should be connected to a Solid State drive or a Hard Disk Drive. The options are Hard Disk Drive and Solid State Drive.

PCIe/PCI/PnP



Above 4G Decoding (Available if the system supports 64-bit PCI decoding)

Select Enabled to decode a PCI device that supports 64-bit in the space above 4G Address. The options are Enabled and **Disabled**.

SR-IOV Support

Single Root I/O Virtualization (SR-IOV) is a specification that allows a PCIe device to appear as multiple physical devices to the system. The options are **Disabled** and Enabled.

PCI PERR/SERR Support

Select Enabled to activate PCI Error and System Error report handling. The options are Enabled and **Disabled**.

CPU SLOT1 PCI-E 3.0 X8 (IN X16) BIFURCATION

This option allows the user to electrically divide the above slot into x4x4, x8 or auto. The options are **Auto**, x4x4, x8.

CPU SLOT6 PCI-E 3.0 X16 BIFURCATION

This option allows the user to electrically divide the above slot electrical segments. The options are **Auto**, x4x4x4x4, x4x4x8, x8x4x4, x8x8 or x16.

SLOT2 and SLOT4 Selection

This option allows the user to select between activating Slot2 and Slot4 both at x8 OR, Slot4 at x16. The options are **Slot2(x8) and Slot4(x)**, or Slot4(x16).

**CPU SLOT1 PCI-E 3.0 X8 (IN X16) - GEN X,
CPU SLOT2 PCI-E 3.0 X8 (IN X16) - GEN X,
CPU SLOT4 PCI-E 3.0 X8 (IN X16) - GEN X,
CPU SLOT6 PCI-E 3.0 X16 - GEN X**

This option allows the PCI-E Generation (GT/s) speed selection of the above slots. The options are **Auto**, Gen 1 (2.5 GT/s), Gen 2 (5 GT/s), Gen 3 (8GT/s).

**CPU SLOT1 PCI-E 3.0 X8 (IN X16) OPROM,
CPU SLOT2 PCI-E 3.0 X8 (IN X16) OPROM,
PCH SLOT3 PCI-E 2.0 X1 (IN X4) OPROM,
CPU SLOT4 PCI-E 3.0 X8 (IN X16) OPROM,
PCH SLOT5 PCI-E 2.0 X1 (IN X4) OPROM,
CPU SLOT6 PCI-E 3.0 X16 OPROM**

Select Disabled to deactivate the selected slot, Legacy to activate the slot in legacy mode and EFI to activate the slot in EFI mode. The options are Disabled, **Legacy**, and EFI.

Video Option ROM Type (X10SRA-F)

For the onboard video device, select an option to select the Video Option ROM type to boot from. The options are Do Not Launch, **Legacy** and EFI.

Onboard LAN Option ROM Type

Select an option to enable Option ROM support to boot the computer using a network device specified by the user. The options are Disabled, **Legacy** and EFI.

Onboard LAN1 Option ROM/Onboard LAN2 Option ROM

Select PXE (Preboot Execution Environment) to boot the computer using a PXE device installed in a LAN port specified. Select Disabled to prevent system boot using a device installed in a LAN port. The options for Onboard LAN1 Option ROM/Onboard LAN2 Option ROM are **Disabled** and PXE.

Network Stack

This feature configures the Network Stack library for resource fetching. The options are **Auto** and Disabled.

ASPM Support

This feature configures the ASPM (Active State Power Management) setting for the graphics installed graphics device. The options are **Auto** and Disabled.

VGA Priority

Use this item to select the graphics device to be used as the primary video display for system boot. The options are **Auto** (for the X10SRA), **Onboard VGA** (for the X10SRA-F), CPU SLOT1 PCI-E 3.0 X8 (IN X16), CPU SLOT2 PCI-E 3.0 X8 (IN X16), PCH SLOT3 PCI-E 2.0 X1 (IN X4), CPU SLOT4 PCI-E 3.0 X8 (IN X16), PCH SLOT5 PCI-E 2.0 X1 (IN X4), and CPU SLOT6 PCI-E 3.0 X16.

USB Settings

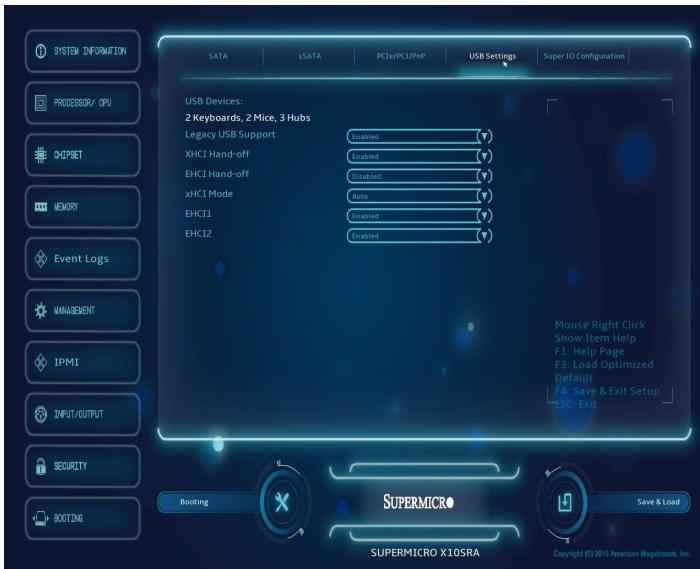

The following will be displayed:

- **USB Devices** - this displays a list of the detected USB devices.

Legacy USB Support

Select Enabled to support onboard legacy USB devices. Select Auto to disable legacy support if there are no legacy USB devices present. Select Disabled to have all USB devices available for EFI applications only. The options are **Enabled**, Disabled and Auto.

XHCI Hand-Off

This is a work-around solution for operating systems that do not support XHCI (Extensible Host Controller Interface) hand-off. The XHCI ownership change should be claimed by the XHCI driver. The settings are **Enabled** and Disabled.

EHCI Hand-Off

This item is for operating systems that do not support Enhanced Host Controller Interface (EHCI) hand-off. When this item is enabled, EHCI ownership change will be claimed by the EHCI driver. The settings are Enabled and **Disabled**.

XHCI Mode

This feature handles the operation mode for the XHCI (Extensible Host Controller Interface) controller. The settings are **Smart Auto**, Auto, Enabled, and Disabled.

EHCI1

Select Enabled to enable EHCI (Enhanced Host Controller Interface) support on USB 2.0 connector #1 (-at least one USB 2.0 connector should be enabled for EHCI support.) The options are Disabled and **Enabled**.

EHCI2

Select Enabled to enable EHCI (Enhanced Host Controller Interface) support on USB 2.0 connector #2 (-at least one USB 2.0 connector should be enabled for EHCI support.) The options are Disabled and **Enabled**.

Super IO Configuration

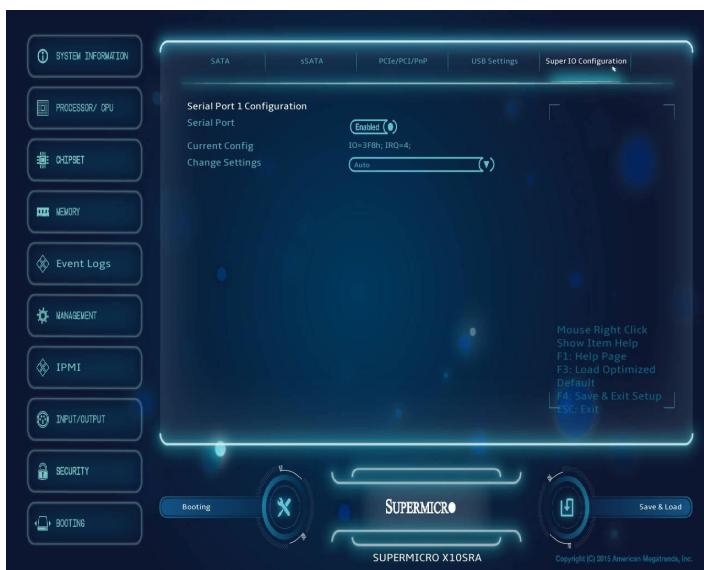

Serial Port 1 Configuration

This item will Enable or Disable Serial Port 1 (COM1). Place a tick mark on the box to enable Serial Port 1. The default is **Enabled**.

Current Config (IRQ)

This item displays the current IRQ setting for Serial Port 1 (COM1).

Change (IRQ) Settings

This item configures the IRQ setting for Serial Port 1 (COM1).

The options for Serial Port 1 are **Auto**, IO=3F8h; IRQ=4, IO=3F8h; IRQ=3, 4, 5, 6, 7, 9, 10, 11, 12, IO=2F8h; IRQ=3, 4, 5, 6, 7, 9, 10, 11, 12), IO=3E8h; IRQ=3, 4, 5, 6, 7, 9, 10, 11, 12 and IO=2E8h; IRQ=3, 4, 5, 6, 7, 9, 10, 11, 12.

4-11 Security

Password

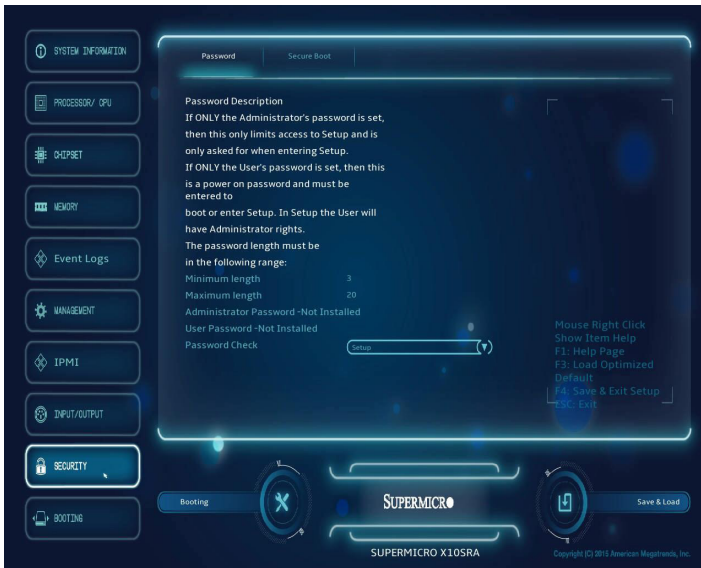

This menu allows the user to configure the following security settings for the system.

- If the Administrator password is defined ONLY - this controls access to the BIOS setup ONLY.
- If the User's password is defined ONLY - this password will need to be entered upon each system boot, and will also have Administrator rights in the setup.
- Passwords must be at least 3 and up to 20 characters long.

Administrator Password

Use this feature to set the Administrator Password which is required to enter the BIOS setup utility. The length of the password should be from 3 characters to 20 characters long.

User Password

Use this feature to set the User Password, which is required everytime the system boots. The length of the password should be from 3 characters to 20 characters long.

User Password

Use this feature to set whether to ask for a password everytime the system boots (Always) or only during BIOS setup. The options are **Setup** and Always.

Secure Boot

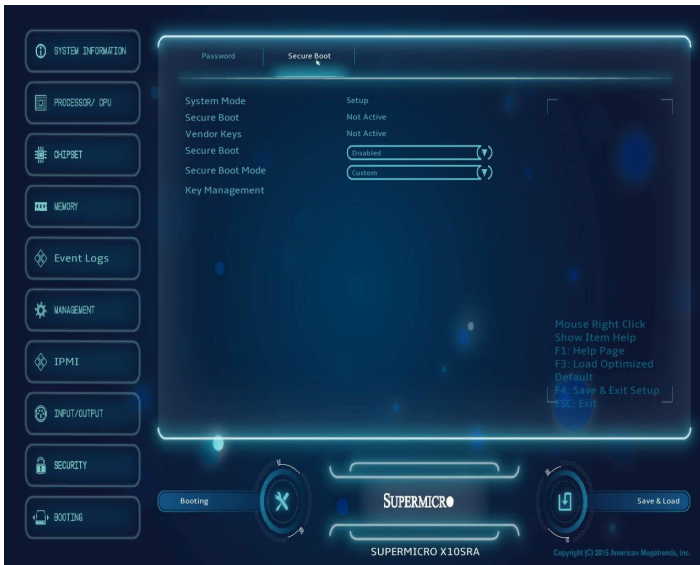

The following items will be displayed:

- **System Mode** - indicates the current system mode.
- **Secure Boot** - this item indicates if Secure Boot is activated or not.
- **Vendor Keys** - indicates if Vendor Keys are activated or not.

Secure Boot

Select Enabled for Secure Boot flow control. This feature is available when the platform key (PK) is pre-registered, the platform operates in the user mode, and CSM is disabled in the Setup utility. The options are **Disabled** and Enabled.

Secure Boot Mode

This feature allows selection of the Secure Boot Mode between Standard and Custom. Selecting Custom enables users to change the Image Execution Policy and manage Secure Boot Keys. The options are **Custom** and Standard.

Key Management

(if Secure Boot Mode is set to 'Custom')

Key Management allows experienced users to modify Secure Boot Variables.

Default Key Provision

This item will load the default key provision. The options are **Enabled** and Disabled.

Enroll All Factory Default Keys

This item will install the factory default secure variables. The options are **Yes** and No.

Save All Secure Boot Variables

This item will save all the revised secure boot variables. The options are **Yes** and No.

Platform Key

This item displays the current Platform Key status.

Delete PK

This item deletes a previously installed Platform Key.

Set New PK

This item uploads and installs a secure Platform Key. You may insert a factory default key or load from a file. The file formats accepted are:

- 1) Public Key Certificate
 - a. EFI Signature List

- b. EFI CERT X509 (DER Encoded)
 - c. EFI CERT RSA2048 (bin)
 - d. EFI SERT SHA256 (bin)
- 2) EFI Time Based Authenticated Variable

When prompted, select "Yes" to load Factory Defaults or "No" to load from a file.

Key Exchange Key

This item displays the current Key Exchange Key status.

Delete KEK

This item deletes a previously installed Key Exchange Key.

Set New KEK

This item uploads and installs a Key Exchange Key. You may insert a factory default key or load from a file. When prompted, select "Yes" to load Factory Defaults or "No" to load from a file.

Append KEK

This item uploads and adds a Key Exchange Key into the Key Management. You may insert a factory default key or load from a file. When prompted, select "Yes" to load Factory Defaults or "No" to load from a file.

Authorized Signatures

This item displays the current Authorized Signatures status.

Delete DBT

This item deletes a previously installed Authorized Signature.

Set New DBT

This item uploads and installs an Authorized Signature . You may insert a factory default key or load from a file. The file formats accepted are:

- 1) Public Key Certificate
 - a. EFI Signature List
 - b. EFI CERT X509 (DER Encoded)
 - c. EFI CERT RSA2048 (bin)
 - d. EFI SERT SHA256 (bin)
- 2) EFI Time Based Authenticated Variable

When prompted, select "Yes" to load Factory Defaults or "No" to load from a file.

Append DBT

This item uploads and adds an Authorized Signature into the Key Management. You may insert a factory default key or load from a file. When prompted, select "Yes" to load Factory Defaults or "No" to load from a file.

Forbidden Signatures

This item displays the current Forbidden Signatures status.

Delete DBX

This item deletes a previously installed Forbidden Signature.

Set New DBX

This item uploads and installs a Forbidden Signature . You may insert a factory default key or load from a file. The file formats accepted are: 1) Public Key Certificate

- a. EFI Signature List
 - b. EFI CERT X509 (DER Encoded)
 - c. EFI CERT RSA2048 (bin)
 - d. EFI SERT SHA256 (bin)
- 2) EFI Time Based Authenticated Variable

When prompted, select "Yes" to load Factory Defaults or "No" to load from a file.

Append DBX

This item uploads and adds an Forbidden Signature into the Key Management. You may insert a factory default key or load from a file. When prompted, select "Yes" to load Factory Defaults or "No" to load from a file.

4-12 Booting

The different boot settings and options for the motherboard are in this section.

Boot Device Settings



Quiet Boot

This option sets the state to which the system buzzer is configured when booting. The default is **Enabled**, the buzzer is silent.

Boot Mode Select

Use this item to select the type of device to be used for system boot. The options are Legacy, UEFI, and **Dual**.

Fixed Boot Order Priorities

This option prioritizes the order of bootable devices from which the system will boot. Press <Enter> on each entry from top to bottom to select devices.

- Dual Boot Order #1
- Dual Boot Order #2

- Dual Boot Order #3
- Dual Boot Order #4
- Dual Boot Order #5
- Dual Boot Order #6
- Dual Boot Order #7
- Dual Boot Order #8
- Dual Boot Order #9
- Dual Boot Order #10
- Dual Boot Order #11
- Dual Boot Order #12
- Dual Boot Order #13
- Dual Boot Order #14
- Dual Boot Order #15
- HDD Special Boot Instance
- CD/DVD Special Boot Instance
- USB Hard Disk Special Boot Instance
- USB CD/DVD Special Boot Instance
- USB Key Special Boot Instance
- USB Floppy Special Boot Instance
- Network Special Boot Instance

Delete Driver Option

Use this option to delete a previously-installed driver.

Network Drive BBS Priorities

- Legacy Boot Order #1, the options are [IBA GE Slot 0500 ...] and Disabled.

UEFI Application BBS Priorities

- UEFI Boot Order #1, the options are [UEFI Built-in EFI Shell ...] and Disabled.

BIOS Features

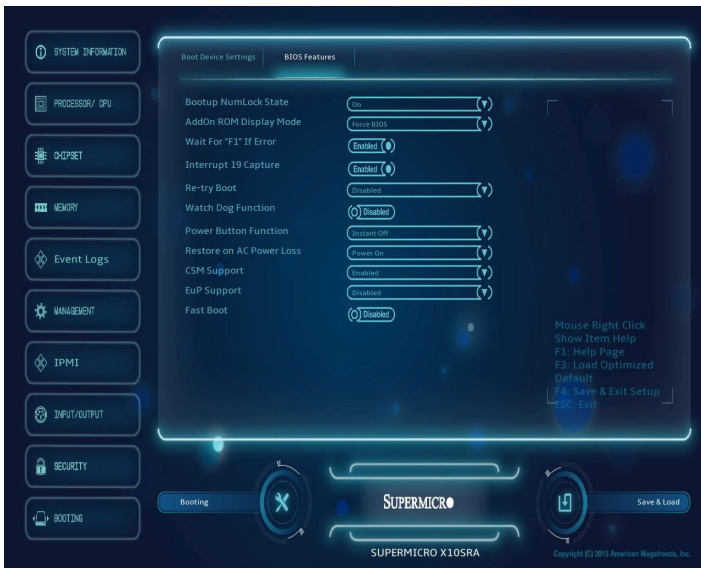

Bootup Numlock State

This option sets the state to which the NumLock key is configured when booting. The default is **On**.

AddOn ROM Display Mode

This item sets the display mode for the Option ROM. Select Keep Current to use the current AddOn ROM Display setting. Select Force BIOS to use the Option ROM display mode set by the system BIOS. The options are **Force BIOS** and Keep Current.

Wait for "F1" for Error

This option sets whether the system will wait for the user to press "F1" when an error is detected during POST. The default is **Enabled**.

Interrupt 19 Capture

Interrupt 19 is the software interrupt that handles the boot disk function. When this item is set to Enabled, the ROM BIOS of the host adaptors will "capture" Interrupt 19 at bootup and allow the drives that are attached to these host adaptors to function as bootable disks. If this item is set to Disabled, the ROM BIOS of the host adaptors will not capture Interrupt 19, and the drives attached to these adaptors will not function as bootable devices. The options are **Enabled** and Disabled.

Retry Boot

Select Enabled to force the system to reboot when system fails to boot. The options are **Disabled** and Enabled.

Watch Dog Function

If enabled, the Watch Dog timer will allow the system to reboot when it is unresponsive for more than 5 minutes. The default is **Enabled**.

Power Button Function

This feature controls how the system shuts down when the power button is pressed. Select 4 Seconds Override for the user to power off the system after pressing and holding the power button for 4 seconds or longer. Select Instant Off to instantly power off the system as soon as the user presses the power button. The options are **Instant Off**, and 4 Seconds Override.

Restore on AC Power Loss

Use this feature to set the power state after a power outage. Select Power-Off for the system power to remain off after a power loss. Select Power-On for the system power to be turned on after a power loss. Select Last State to allow the system to resume its last power state before a power loss. The options are **Last State**, Power On, Stay Off.

CSM Support

This option enables the Compatibility Support Module (CSM) which permits the loading of a traditional OS or the use of a traditional OpROMs. The options are **Enabled** and Disabled.

EUP Support

EuP, or Energy Using Product is a European energy-saving specification that sets a standard on the maximum total power consumption on electrical products. Select Enabled to activate EUP support, select **Disabled** for normal S5 sleep mode (system wakeup capability).

Fast Boot

This option sets fast system boot, quick POST, etc . The default is **Disabled**.

Appendix A

BIOS Error Beep Codes

During the POST (Power-On Self-Test) routines, which are performed each time the system is powered on, errors may occur.

Non-fatal errors are those which, in most cases, allow the system to continue with bootup. The error messages normally appear on the screen.

Fatal errors will not allow the system to continue to bootup. If a fatal error occurs, you should consult with your system manufacturer for possible repairs.

These fatal errors are usually communicated through a series of audible beeps. The numbers on the fatal error list correspond to the number of beeps for the corresponding error.

A-1 BIOS Error Beep Codes

BIOS Error Beep Codes		
Beep Code/LED	Error Message	Description
1 beep	Refresh	Circuits have been reset. (Ready to power up)
5 short beeps + 1 long beep	Memory error	No memory detected in the system
5 short beeps	Display error	System display error
OH LED On	System OH	System Overheat

Notes

Appendix B

Software Installation Instructions

B-1 Installing Drivers

After you've installed the Windows Operating System, a screen as shown below will appear. You are ready to install software programs and drivers that have not yet been installed. To install these software programs and drivers, click the icons to the right of these items. (**Note:** To install the Windows Operating System, please refer to the instructions posted on our website at <http://www.supermicro.com/support/manuals/>.)



Driver/Tool Installation Display Screen



Note 1. Click the icons showing a hand writing on the paper to view the readme files for each item. Click on a computer icon to the right of an item to install this item (from top to the bottom), one at a time. After installing each item, you must reboot the system before proceeding with the next item on the list. The bottom icon with a CD on it allows you to view the entire contents of the CD.

Note 2. When making a storage driver diskette by booting into a Driver CD, please set the SATA Configuration to "Compatible Mode" and configure SATA as IDE in the BIOS Setup. After making the driver diskette, be sure to change the SATA settings back to your original settings.

B-2 Configuring SuperDoctor® III

The SuperDoctor III program is a Web-based management tool that supports remote management capability. It includes Remote and Local Management tools. The local management tool is called the SD III Client. The SuperDoctor III program included on the CDROM that came with your motherboard allows you to monitor the environment and operations of your system. SuperDoctor III displays crucial system information such as CPU temperature, system voltages and fan status. See the Figure below for a display of the SuperDoctor III interface.



Note: 1 The default user name and password are ADMIN.

Note 2: In the Windows OS environment, the SuperDoctor III settings take precedence over the BIOS settings. When first installed, SuperDoctor III adopts the temperature threshold settings previously set in BIOS. Any subsequent changes to these thresholds must be made within SuperDoctor, since the settings override the BIOS settings. For the Windows OS to adopt the BIOS temperature threshold settings, please change the SD III Client settings to be the same as those set in BIOS.

SuperDoctor III Interface Display Screen-I (Health Information)

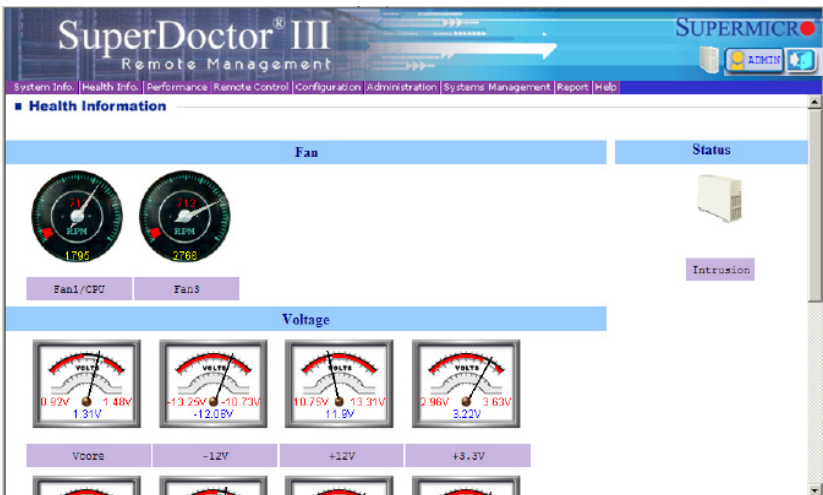

SuperDoctor III Interface Display Screen-II (Remote Control)



Remote Control

Graceful power control (cancelable)

Super Doctor III allows a user to inform the OS to reboot or shut down the system within 30 seconds. On the system console, a pop-up window will appear with a message telling the local user to save his working files. Before the system reboots or shuts down, it's allowed to cancel the action either locally or remotely.

Power control (noncancelable)

Supero Doctor III allows a user to inform the OS to reboot or shut down the system right away. The system will reboot or shut down without any warning messages. It's not allowed to cancel the action.



Note: The SuperDoctor III software and manual may be downloaded from our Website at:

<http://www.supermicro.com/products/accessories/software/SuperDoctorIII.cfm>.

For Linux, we still recommend that you use SuperDoctor II, this version is also available for download at the link above.

Notes

Appendix C

UEFI BIOS Recovery Instructions

! **Attention!** Do not upgrade the BIOS unless your system has a BIOS-related issue. Flashing the wrong BIOS can cause irreparable damage to the system. In no event shall Supermicro be liable for direct, indirect, special, incidental, or consequential damages arising from a BIOS update. If you need to update the BIOS, do not shut down or reset the system while the BIOS is updating to avoid possible boot failure.

C-1 An Overview to the UEFI BIOS

The Unified Extensible Firmware Interface (UEFI) specification provides a software-based interface between the operating system and the platform firmware in the pre-boot environment. The UEFI specification supports an architecture-independent mechanism for add-on card initialization to allow the UEFI OS loader, which is stored in the add-on card, to boot up the system. UEFI offers a clean, hands-off control to a computer system at bootup.

C-2 How to Recover the UEFI BIOS Image (-the Main BIOS Block)

A UEFI BIOS flash chip consists of a recovery BIOS block, comprised of two boot blocks and a main BIOS block (a main BIOS image). The boot block contains critical BIOS codes, including memory detection and recovery codes for the user to flash a new BIOS image if the original main BIOS image is corrupted. When the system power is on, the boot block codes execute first. Once that is completed, the main BIOS code will continue with system initialization and bootup.



Note: Follow the BIOS Recovery instructions below for BIOS recovery when the main BIOS boot crashes. However, when the BIOS boot block crashes, you will need to follow the procedures in Appendix D.

C-3 To Recover the Main BIOS Block Using a USB-Attached Device

This feature allows the user to recover a BIOS image using a USB-attached device without additional utilities used. A USB flash device such as a USB Flash Drive, or a USB CD/DVD ROM/RW device can be used for this purpose. However, a USB Hard Disk drive cannot be used for BIOS recovery at this time.

The file system supported by UEFI is FAT (including FAT12, FAT16, and FAT32) installed on a bootable or non-bootable USB-attached device. However, the BIOS might need several minutes to locate the SUPER.ROM file if the media size becomes too large because it contains too many folders and files.

To perform UEFI BIOS recovery using a USB-attached device, follow the instructions below.

1. Using a different machine, copy the "Super.ROM" binary image file into the disc Root "" Directory of a USB device or a writeable CD/DVD.





Note: If you cannot locate the "SUPER.ROM" file in your driver disk, visit our website at www.supermicro.com to download the BIOS image into a USB flash device (save in the root folder) and rename it "SUPER.ROM" for BIOS recovery use.

2. Insert the USB device that contains the new BIOS image ("SUPER.ROM") into any available USB port. Be sure the file is saved in the very top (root) folder.
3. Set the JBR1 switch on the motherboard to recovery mode and power on the system. If the screen appears as below, press to continue.

```
Version 2.16.1243. Copyright (C) 2013 American Megatrends, Inc.
Supermicro C7297-OCE BIOS Date:04/25/2014 Rev:1.0
CPU : Intel(R) Core(TM) i7-4765T CPU @ 2.00GHz
Speed : 2.00 GHz
The IMC is operating with DDR3L 1333 Mhz
Setup default has been loaded.
Press <DEL> to run Setup
Press <F1> to Continue Booting
```

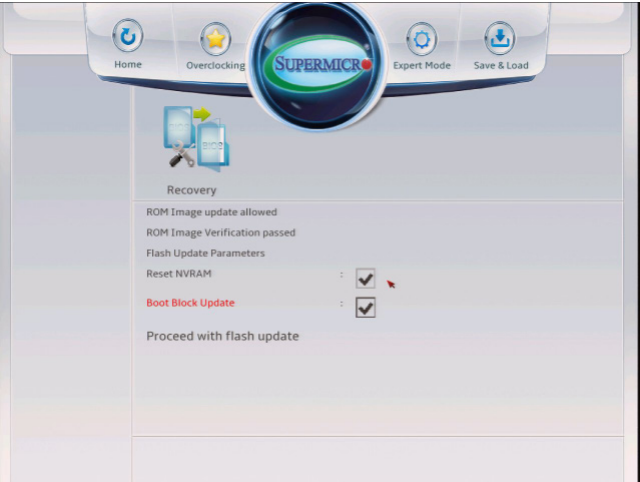
- 4. After locating the new BIOS binary image, the system will enter the BIOS Recovery menu as shown below.



 **Note:** At this point, you may decide if you want to start with BIOS Recovery. If you decide to proceed with BIOS Recovery, follow the procedures below.

- 5. To continue with BIOS Recovery, select the item- "Proceed with flash update". You will see the progress of BIOS Recovery as shown on the screens below.

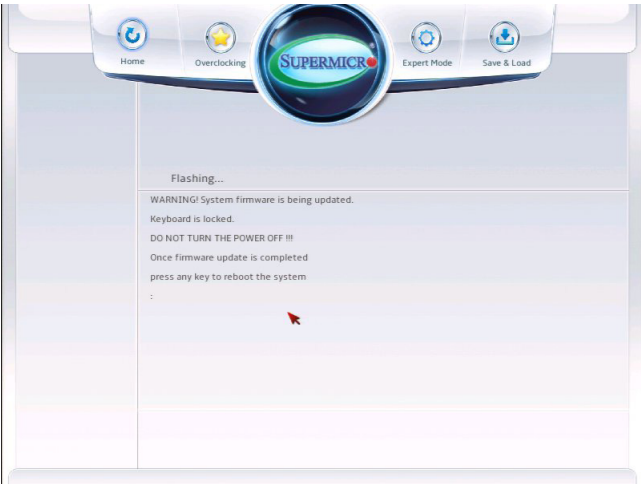

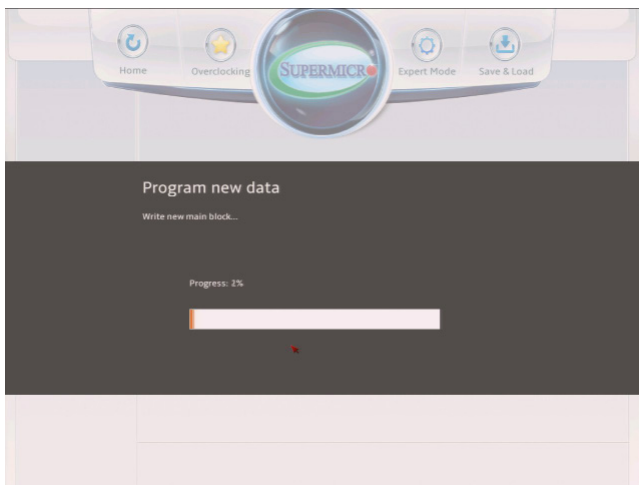

Note: *Do not interrupt* the BIOS programming until it is completed.

6. After the BIOS Recovery process is complete, click OK to reboot the system.

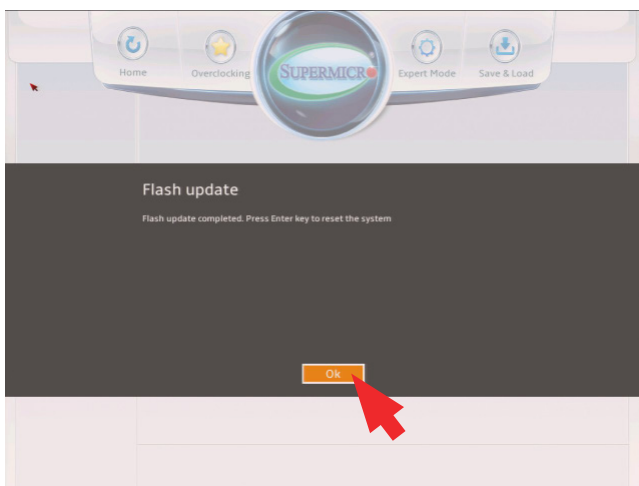

Appendix D

Dual Boot Block

D-1 Introduction

This motherboard supports the Dual Boot Block feature, which is the last-ditch mechanism to recover the BIOS boot block. This section provides an introduction to the feature.

BIOS Boot Block

A BIOS boot block is the minimum BIOS loader required to enable necessary hardware components for the BIOS crisis recovery flash that will update the main BIOS block. An on-call BIOS boot-block corruption may occur due to a software tool issue (see image below) or an unexpected power outage during BIOS updates.

```

-----
                AMI Firmware Update Utility vX.XX.XX
                Copyright (C)XXXX American Megatrends Inc. All Rights Reserved.
-----
Reading flash . . . . . done
-- ME Data Size checking . ok
-- FFS checksums . . . . . ok
Erasing Boot Block . . . . . done
_ Updating Boot Block . . . . . 0x00A91000 (13%)

```

BIOS Boot Block Corruption Occurrence

When a BIOS boot block is corrupted due to an unexpected power outage or a software tool malfunctioning during BIOS updates, you can still reboot the system by activating switch JBR1 on the motherboard. When JBR1 is activated, the system will boot from a backup boot block pre-loaded in the BIOS by the manufacturer.

D-2 Steps to Reboot the System by switch JBR1

1. Power down the system.
2. On switch JBR1 slide switch to ON, and power on the system.
3. Follow the BIOS recovery SOP listed in the previous chapter (Appendix C).
4. After completing the steps above, power down the system.
5. Turn OFF switch JBR1, and power on the system.

(Disclaimer Continued)

The products sold by Supermicro are not intended for and will not be used in life support systems, medical equipment, nuclear facilities or systems, aircraft, aircraft devices, aircraft/emergency communication devices or other critical systems whose failure to perform be reasonably expected to result in significant injury or loss of life or catastrophic property damage. Accordingly, Supermicro disclaims any and all liability, and should buyer use or sell such products for use in such ultra-hazardous applications, it does so entirely at its own risk. Furthermore, buyer agrees to fully indemnify, defend and hold Supermicro harmless for and against any and all claims, demands, actions, litigation, and proceedings of any kind arising out of or related to such ultra-hazardous use or sale.