



APPENDIX **A**

Power Supply Specifications

Revised: March 2013

This appendix describes the power supplies supported by the Catalyst 4500 E-series switches. The appendix contains the following sections:

- [1000 W AC-Input Power Supply, page A-2](#)
- [1300 W AC-Input Power Supply, page A-6](#)
- [1400 W AC-Input Power Supply, page A-10](#)
- [1400 W DC-Input Power Supply, page A-15](#)
- [1400 W Triple-Input DC-Input Power Supply, page A-18](#)
- [2800 W AC-Input Power Supply, page A-24](#)
- [4200 W AC-Input Power Supply, page A-28](#)
- [6000 W AC-Input Power Supply, page A-34](#)
- [9000 W AC-Input Power Supply, page A-42](#)
- [Environmental Monitoring Feature, page A-51](#)
- [Power Redundancy, page A-51](#)



Tip

For additional information about the Cisco Catalyst 4500 E-series switches (including configuration examples and troubleshooting information), see the documents listed on this page:

<http://www.cisco.com/en/US/products/hw/switches/ps4324/index.html>



Note

All Catalyst 4500 E-series switch AC-input power supplies require single-phase source AC. The source AC can be out of phase between multiple power supplies or multiple AC-power plugs on the same power supply because all AC power supply inputs are isolated. Each chassis power supply should have its own dedicated branch circuit: 15 A or 20 A for North America and circuits sized to local and national codes for International locations.

For more information about power management and planning, see the “Environmental Monitoring and Power Management” chapter in the *Software Configuration Guide* version appropriate for your software.

1000 W AC-Input Power Supply

The 1000 W AC-input power supply (PWR-C45-1000AC), shown in [Figure A-1](#), is supported in the following Catalyst 4500 E-Series switches:

- Catalyst 4503-E
- Catalyst 4506-E
- Catalyst 4507R-E
- Catalyst 4507R+E
- Catalyst 4510R-E (the 1000 W AC-input power supply can be installed in the Catalyst 4510R-E switch chassis; however power management is required)
- Catalyst 4510R+E (the 1000 W AC-input power supply can be installed in the Catalyst 4510R+E switch chassis; however power management is required)

Figure A-1 1000 W AC-Input Power Supply Features

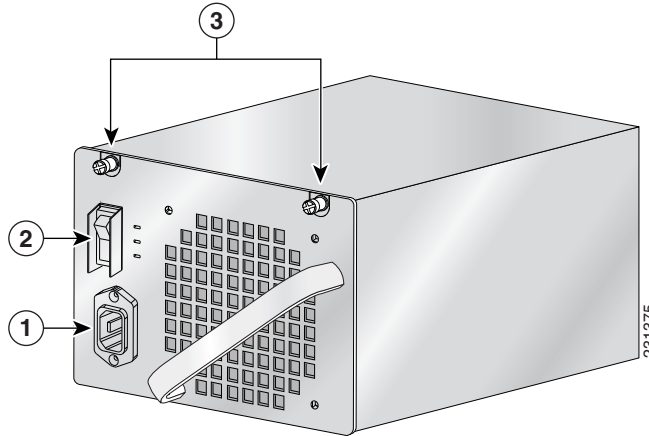

1	AC-input receptacle	3	Captive installation screws
2	Power on/off switch		

1000 W AC-Input Power Supply Specifications

Table A-1 lists the specifications for the 1000 W AC-input power supply.

Table A-1 1000 W AC-Input Power Supply Specifications

Item	Specification
AC-input type	<p>Autoranging input with power factor correction (PFC)</p> <p>Note Power factor correction is a standard feature on all Catalyst 4500 E-series AC-input power supplies. PFC reduces the reactive component in the source AC current allowing higher power factors (typically 99 percent or better) and lower harmonic current components.</p>
AC-input voltage	<ul style="list-style-type: none"> • Low-line (120 VAC nominal)—85 VAC (min) to 132 VAC (max) • High-line (230 VAC nominal)—170 VAC (min) to 264 VAC (max)
AC-input current	<ul style="list-style-type: none"> • 12 A @ 120 VAC • 5 A @ 240 VAC
AC-input frequency	50/60 Hz (nominal) (± 3 Hz for full range)
Branch circuit requirement	<p>Each chassis power supply should have its own dedicated, fused-branch circuit:</p> <ul style="list-style-type: none"> • For North America—15 A or 20 A • For International—Circuits sized to local and national codes • All Catalyst 4500 E-series AC-input power supplies require single-phase source AC. • All AC power supply inputs are fully isolated. <ul style="list-style-type: none"> – Source AC can be out of phase between multiple power supplies in the same chassis, which means that PS1 can be operating from phase A and PS2 can be operating from phase B. – For high-line operation, the power supply operates with the hot conductor wired to a source AC phase and the neutral conductor wired either to ground or to another source AC phase as long as the net input voltage is in the range of 170 to 264 VAC. – Source AC can be out of phase between AC inputs on power supplies that are equipped with multiple AC inputs, which means that power cord 1 can be plugged into phase A and power cord 2 can be plugged into phase B.

Table A-1 1000 W AC-Input Power Supply Specifications (continued)

Item	Specification
Power supply output capacity	1050 W plus 40 W (fan)
Power supply output	83.4 A @ +12 VDC 12.2 A @ +3.3 VDC
Output holdup time	20 ms minimum
Maximum kVA rating	1.32 kVA
Max heat dissipation	943 BTUs/hr
Minimum software requirement	Cisco IOS Release 12.1(12c)EW
Power over Ethernet	Not supported ¹

1. A Catalyst 4503 with a Catalyst 4500 series Supervisor Engine II-Plus TS and a 1000 W power supply will be able to provide 158.4 W of Power over Ethernet (PoE) to ports on the supervisor engine. Switching modules in the other slots will not be able to provide PoE.

Table A-2 lists the 1000 W AC-input power supply LEDs and their meanings.

Table A-2 1000 W AC-Input Power Supply LEDs

LED	Meaning
INPUT OK	<ul style="list-style-type: none"> Green—Source AC voltage is OK. (Input voltage is 85 VAC or greater.) Off—Source AC voltage falls below 70 VAC, is not present, or the power supply is turned off.
FAN OK	<ul style="list-style-type: none"> Green—Power supply fan is operating properly. Off—Power supply fan failure is detected.
OUTPUT FAIL	<ul style="list-style-type: none"> Red—Problem with one or more of the DC-output voltages of the power supply is detected. Off—DC-output voltage with acceptable margins.

1000 W Power Supply AC Power Cords

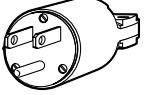
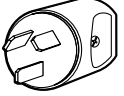
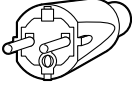



Table A-3 lists the specifications for the regional AC power cords that are available for the 1000 W AC-input power supply.



Note

All 1000 W power supply AC power cords have an IEC60320/C15 appliance plug at one end.

Table A-3 1000 W AC Power Supply Power Cords

Locale	Power Cord Part Number	Length	Cordset Rating	Plug Type
Japan, North America	CAB-US515-C15-US= (was CAB-7KAC=)	8.2 ft (2.5 m)	15 A, 125 VAC	NEMA 5-15P  120354
Australia, New Zealand	CAB-AS3112-C15-AU= (was CAB-7ACA=)	8.2 ft (2.5 m)	15 A, 250 VAC	AS/NZS 3112-1993  120356
Europe (except Italy)	CAB-CEE77-C15-EU= (was CAB-7ACE=)	8.2 ft (2.5 m)	16 A, 250 VAC	CEE 7/7  120357
Italy	CAB-C2316-C15-IT= (was CAB-7ACI=)	8.2 ft (2.5 m)	16 A, 250 VAC	1/3/16 CEI 23-16  120358
United Kingdom	CAB-BS1363-C15-UK= (was CAB-7ACU=)	8.2 ft (2.5 m)	13 A, 250 VAC	BS 1363/A ¹  120359
Argentina	CAB-IR2073-C15-AR= (was CAB-7KACR=)	8.2 ft (2.5 m)	10 A, 250 VAC	IRAM 2073  120356

1. Plug contains a 13 A fuse.

1300 W AC-Input Power Supply

The 1300 W AC-input power supply (PWR-C45-1300ACV), shown in [Figure A-2](#), is supported in the following Catalyst 4500 E-series switches:

- Catalyst 4503-E
- Catalyst 4506-E
- Catalyst 4507R-E
- Catalyst 4507R+E
- Catalyst 4510R-E (the 1300 W AC-input power supply can be installed in the Catalyst 4510R-E switch chassis; however power management is required)
- Catalyst 4510R+E (the 1300 W AC-input power supply can be installed in the Catalyst 4510R+E switch chassis; however power management is required)

Figure A-2 1300 W AC-Input Power Supply Features

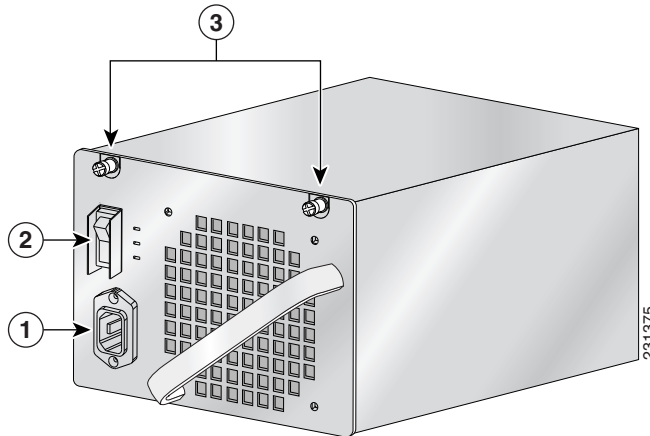

1	AC-input receptacle	3	Captive installation screws
2	Power on/off switch		

1300 W AC-Input Power Supply Specifications

[Table A-4](#) lists the specifications for the 1300 W AC-input power supply.

Table A-4 1300 W AC-Input Power Supply Specifications

Item	Specification
AC-input type	Autoranging input with power factor corrector Note Power factor correction is a standard feature on all Catalyst 4500 E-series AC-input power supplies. PFC reduces the reactive component in the source AC current allowing higher power factors (typically 99 percent or better) and lower harmonic current components.
AC-input voltage	<ul style="list-style-type: none"> • Low-line (120 VAC nominal)—85 VAC (min) to 132 VAC (max) • High-line (230 VAC nominal)—170 VAC (min) to 264 VAC (max)
AC-input current	<ul style="list-style-type: none"> • 16 A @ 100 VAC • 7 A @ 240 VAC
AC-input frequency	50/60 Hz (nominal) (± 3 Hz for full range)
Branch circuit requirement	Each chassis power supply should have its own dedicated, fused-branch circuit: <ul style="list-style-type: none"> • For North America—15 A or 20 A • For International—Circuits sized to local and national codes • All Catalyst 4500 E-series AC-input power supplies require single-phase source AC. • All AC power supply inputs are fully isolated. <ul style="list-style-type: none"> – Source AC can be out of phase between multiple power supplies in the same chassis, which means that PS1 can be operating from phase A and PS2 can be operating from phase B. – For high-line operation, the power supply operates with the hot conductor wired to a source AC phase and the neutral conductor wired either to ground or to another source AC phase as long as the net input voltage is in the range of 170 to 264 VAC. – Source AC can be out of phase between AC inputs on power supplies that are equipped with multiple AC inputs, which means that power cord 1 can be plugged into phase A and power cord 2 can be plugged into phase B.
Power supply output capacity	<ul style="list-style-type: none"> • 1300 W maximum • 1050 W+ 40 W redundant mode (data) • 1667 W maximum in combined mode (data) • 800 W maximum each in redundant mode (PoE) • 1333 W maximum in combined mode (PoE)

Table A-4 1300 W AC-Input Power Supply Specifications (continued)

Item	Specification
Power supply output	<ul style="list-style-type: none"> 84.7 A @ 12 V @ (data) 12.5 A @ 3.3 V (data) 16.7 A @ -50 V (PoE)
Output holdup time	20 ms minimum
Maximum kVA rating	1.76 kVA
Max heat dissipation	1568 BTUs/hr
Minimum software requirement	Cisco IOS Release 12.1(12c)EW
Power over Ethernet (PoE)	Supported, up to 800 W (211 Cisco phones in combined mode)

Table A-5 lists the 1300 W AC-input power supply LEDs and their meanings.

Table A-5 1300 W AC-Input Power Supply LEDs

LED	Meaning
INPUT OK	<ul style="list-style-type: none"> Green—Source AC voltage is OK. (Input voltage is 85 VAC or greater.) Off—Source AC voltage falls below 70 VAC, is not present, or the power supply is turned off.
FAN OK	<ul style="list-style-type: none"> Green—Power supply fan is operating properly. Off—Power supply fan failure is detected.
OUTPUT FAIL	<ul style="list-style-type: none"> Red—Problem with one or more of the DC-output voltages of the power supply is detected. Off—DC-output voltage with acceptable margins. <p>Note For proper operation of the OUTPUT FAIL LED, systems with single power supplies must be configured with a minimum of one fan tray assembly and one supervisor engine. Systems with dual power supplies must have a minimum configuration of one fan tray assembly, one supervisor engine, and one additional module. Failure to meet these minimum configuration requirements can cause a false power supply output fail signal.</p>

1300 W Power Supply AC Power Cords

Table A-6 lists the specifications for the AC power cords that are available for the 1300 W AC-input power supply. The table includes a power plug illustration for each power cord.



Note

All 1300 W power supply power cords have an IEC60320/C19 appliance plug at one end.

Table A-6 1300 W AC-Input Power Supply Power Cords





Locale	Power Cord Part Number	Length	Cordset Rating	AC Source Plug Type
Japan, North America	CAB-US520-C19-US= (was CAB-7513AC=)	14 ft (4.3 m)	20 A, 125 VAC	NEMA 5-20  120362
Australia, New Zealand	CAB-A3112-C19-AUS= (was CAB-7513ACA=)	14 ft (4.3 m)	15 A, 250 VAC	SAA/3, AS/NZSS 3112-1993  120356
Europe (except Italy)	CAB-CEE77-C19-EU= (was CAB-7513ACE=)	14 ft (4.3 m)	16 A, 250 VAC	CEE 7/7  120357
Italy	CAB-C2316-C19-IT= (was CAB-7513ACI=)	14 ft (4.3 m)	16 A, 250 VAC	1/3/16, CEI 23-16  120358
United Kingdom	CAB-BS1363-C19-UK= (was CAB-7513ACU=)	14 ft (4.3 m)	13 A, 250 VAC	BS 89/13 BS 1363/A  120359
Argentina	CAB-IR2073-C19-AR= (was CAB-7513ACR=)	14 ft (4.3 m)	16 A, 250 VAC	IRAM 2073  120356
Japan, North America (locking) 200–240 VAC operation	CAB-AC-2800W-TWLK=	13.6 ft (4.1 m)	16 A, 250 VAC	NEMA L6-20  120361

Table A-6 1300 W AC-Input Power Supply Power Cords (continued)

Locale	Power Cord Part Number	Length	Cordset Rating	AC Source Plug Type
Japan, North America (nonlocking) 200–240 VAC operation	CAB-AC-2800W-6-20=	13.2 ft (4.0 m)	16 A, 250 VAC	NEMA 6-20 non-locking  120355
Europe	CAB-AC-2800W-EU=	13.2 ft (4.0 m)	16 A, 250 VAC	CEE 7/7  120357
South Africa, India	CAB-BS546-C15-SA= (was CAB-7513ACSA)	13.6 ft (4.1 m)	16 A, 250 VAC	BS 456  203795
International	CAB-AC-2800W-INT=	13.6 ft (4.1 m)	16 A, 250 VAC	IEC 309  120360
Israeli	CAB-S132-C19-ISRL	14 ft (4.3 m)	16 A, 250 VAC	SI32  130922
UPS 220V	CAB-C19-CBN	9 ft (2.74 m)	20 A, 250 VAC	IEC-60320-C20  130923

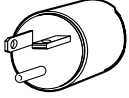
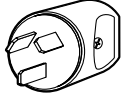
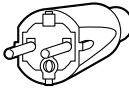
1400 W AC-Input Power Supply

The 1400 W AC-input power supply (PWR-C45-1400AC), shown in [Figure A-3](#), is supported in the following Catalyst 4500 E-series switches:

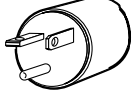
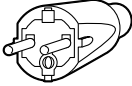
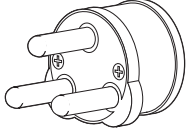
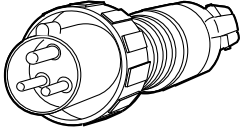
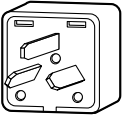
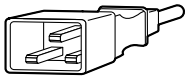
- Catalyst 4503-E
- Catalyst 4506-E
- Catalyst 4507R-E
- Catalyst 4507R+E
- Catalyst 4510R-E
- Catalyst 4510R+E

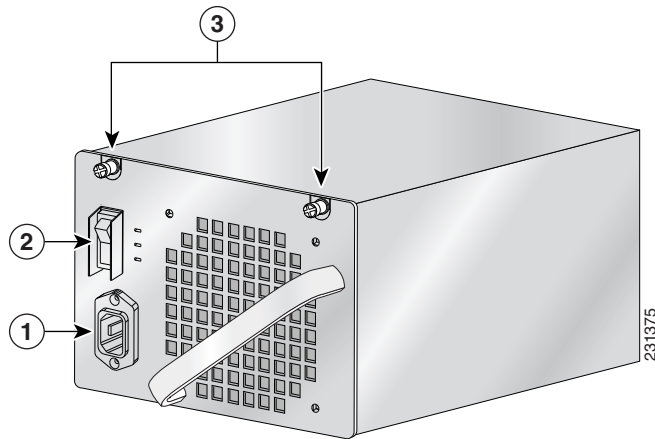
Figure A-3 1400 W AC-Input Power Supply Features

1	AC-input receptacle	3	Captive installation screws
2	Power on/off switch		

1400 W AC-Input Power Supply Specifications

Table A-7 lists the specifications for the 1400 W AC-input power supply.

Table A-7 1400 W AC-Input Power Supply Specifications

Item	Specification
AC-input type	Autoranging input with power factor corrector Note Power factor correction is a standard feature on all Catalyst 4500 E-series AC-input power supplies. PFC reduces the reactive component in the source AC current allowing higher power factors (typically 99 percent or better) and lower harmonic current components.
AC-input voltage	<ul style="list-style-type: none"> Low-line (120 VAC nominal)—85 VAC (min) to 132 VAC (max) High-line (230 VAC nominal)—170 VAC (min) to 264 VAC (max)
AC-input current	<ul style="list-style-type: none"> 16 A @ 120 VAC 7 A @ 240 VAC
AC-input frequency	50/60 Hz (nominal) (± 3 Hz for full range)

Table A-7 1400 W AC-Input Power Supply Specifications (continued)

Item	Specification
Branch circuit requirement	<p>Each chassis power supply should have its own dedicated, fused-branch circuit:</p> <ul style="list-style-type: none"> • For North America—15 A or 20 A • For International—Circuits sized to local and national codes • All Catalyst 4500 E-series AC-input power supplies require single-phase source AC. • All AC power supply inputs are fully isolated. <ul style="list-style-type: none"> – Source AC can be out of phase between multiple power supplies in the same chassis, which means that PS1 can be operating from phase A and PS2 can be operating from phase B. – For high-line operation, the power supply operates with the hot conductor wired to a source AC phase and the neutral conductor wired either to ground or to another source AC phase as long as the net input voltage is in the range of 170 to 264 VAC. – Source AC can be out of phase between AC inputs on power supplies that are equipped with multiple AC inputs, which means that power cord 1 can be plugged into phase A and power cord 2 can be plugged into phase B.
Power supply output	<p>2473 W maximum</p> <p>1360 W + 40 W redundant mode (data)</p>
Power supply output (AC supply)	<p>113.4 A @ +12 V</p> <p>12.2 A @ +3.3 V (data)</p>
Output holdup time	20 ms minimum
Max heat dissipation	1048 BTUs/hr
Maximum kVA rating	1.76 kVA
Minimum software requirement	Cisco IOS Release 12.2(18)EW
Power over Ethernet	Not supported ¹

1. A Catalyst 4503-E with a Catalyst 4500 E-series Supervisor Engine II-Plus TS and a 1400W AC power supply provides 158.4 W of PoE to ports on the supervisor engine. Switching modules in other slots will not be able to provide PoE.

[Table A-8](#) list the 1400 W AC-input power supply LEDs and their meanings.

Table A-8 1400 W AC-Input Power Supply LEDs

LED	Meaning
INPUT OK	<ul style="list-style-type: none"> Green—Source AC voltage is OK. (Input voltage is 85 VAC or greater.) Off—Source AC voltage falls below 70 VAC, is not present, or the power supply is turned off.
FAN OK	<ul style="list-style-type: none"> Green—Power supply fan is operating properly. Off—Power supply fan failure is detected.
OUTPUT FAIL	<ul style="list-style-type: none"> Red—Problem with one or more of the DC-output voltages of the power supply is detected. Off—DC-output voltage with acceptable margins. <p>Note For proper operation of the OUTPUT FAIL LED, systems with single power supplies must be configured with a minimum of one fan tray assembly and one supervisor engine. Systems with dual power supplies must have a minimum configuration of one fan tray assembly, one supervisor engine, and one additional module. Failure to meet these minimum configuration requirements can cause a false power supply output fail signal.</p>

1400 W Power Supply AC Power Cords

Table A-9 lists the specifications for the AC power cords that are available for the 1400 W AC-input power supply. The table includes a power plug illustration for each power cord.

**Note**

All 1400 W power supply power cords have an IEC60320/C19 appliance plug at one end.

Table A-9 1400 W AC-Input Power Supply Power Cords

Locale	Power Cord Part Number	Length	Cordset Rating	AC Source Plug Type
Japan, North America	CAB-US520-C19-US= (was CAB-7513AC=)	14 ft (4.3 m)	20 A, 125 VAC	NEMA 5-20  120362
Australia, New Zealand	CAB-A3112-C19-AUS= (was CAB-7513ACA=)	14 ft (4.3 m)	15 A, 250 VAC	SAA/3, AS/NZS 3112-1993  120356
Europe (except Italy)	CAB-CEE77-C19-EU= (was CAB-7513ACE=)	14 ft (4.3 m)	16 A, 250 VAC	CEE 7/7  120357

Table A-9 1400 W AC-Input Power Supply Power Cords (continued)



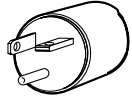
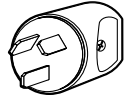
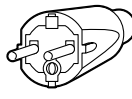

Locale	Power Cord Part Number	Length	Cordset Rating	AC Source Plug Type
Italy	CAB-C2316-C19-IT= (was CAB-7513ACI=)	14 ft (4.3 m)	16 A, 250 VAC	1/3/16, CEI 23-16  120358
United Kingdom	CAB-BS1363-C19-UK= (was CAB-7513ACU=)	14 ft (4.3 m)	13 A, 250 VAC	BS 89/13 BS 1363/A  120359
Argentina	CAB-IR2073-C19-AR= (was CAB-7513ACR=)	14 ft (4.3 m)	16 A, 250 VAC	IRAM 2073  120356
Japan, North America (locking) 200–240 VAC operation	CAB-AC-2800W-TWLK=	13.6 ft (4.1 m)	16 A, 250 VAC	NEMA L6-20  120361
Japan, North America (nonlocking) 200–240 VAC operation	CAB-AC-2800W-6-20	13.2 ft (4.0 m)	16 A, 250 VAC	NEMA 6-20 non-locking  120355
Europe	CAB-AC-2800W-EU=	13.2 ft (4.0 m)	16 A, 250 VAC	CEE 7/7  120357
South Africa, India	CAB-BS546-C15-SA= (was CAB-7513ACSA)	13.6 ft (4.1 m)	16 A, 250 VAC	BS 456  203795
International	CAB-AC-2800W-INT=	13.6 ft (4.1 m)	16 A, 250 VAC	IEC 309  120360

Table A-9 1400 W AC-Input Power Supply Power Cords (continued)

Locale	Power Cord Part Number	Length	Cordset Rating	AC Source Plug Type
Israel	CAB-S132-C19-ISRL	14 ft (4.3 m)	16 A, 250 VAC	SI32  130922
UPS 220 VAC	CAB-C19-CBN	9 ft (2.74 m)	20 A, 250 VAC	IEC-60320-C20  130923

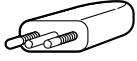
1400 W DC-Input Power Supply

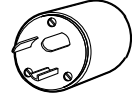
The 1400 W DC-input power supply (PWR-C45-1400DC-P), shown in [Figure A-4](#), is supported in the following Catalyst 4500 E-series switches:

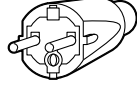
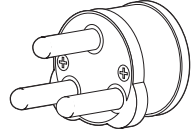
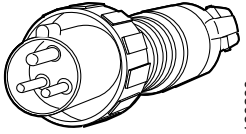
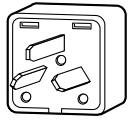
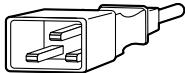
- Catalyst 4503-E
- Catalyst 4506-E
- Catalyst 4507R-E
- Catalyst 4510R-E
- Catalyst 4507R+E
- Catalyst 4510R+E



Caution

Do not install the 1400 W DC power supply with any other power supply under any circumstances. Doing so can seriously damage your switch.

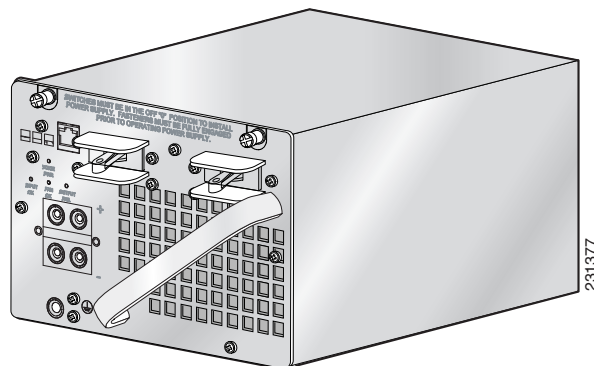
Figure A-4 1400 W DC-Input Power Supply

The 1400W DC-input power supply can be used with the Catalyst 4500 Series AC Power Shelf (PWR-P4502-1PSU). Documentation for the Catalyst 4500 Series AC Power Shelf is located at this url:

http://www.cisco.com/en/US/docs/switches/lan/catalyst4500/hardware/configuration/notes/78_15068.html

1400 W DC-Input Power Supply Specifications

Table A-10 lists the specifications for the 1400 W DC-input power supply.

Table A-10 1400 W DC-Input Power Supply Specifications

Item	Specification
DC-input voltage	–48 to –60 VDC (data only) –48 to –56 VDC (inline devices)
DC-input current	31 A @ –60 VDC (data only) 180 A maximum @ –48 VDC input (data and inline devices) The input power is configurable in the CLI. The Cisco IOS command is power dc input . Configure the switch software to match the requirements of your switch.
Power supply output capacity	<ul style="list-style-type: none"> • Data <ul style="list-style-type: none"> – 12 VDC @ 120 A, – 3.3 VDC @ 10 A – 140 A total maximum (35 A maximum each per 5 channels) @ –48 to –60 VDC input (inline devices) • 1367 W+ 40 W redundant mode (data) 2267 W maximum in combined mode (data) • 7500 W maximum each in redundant mode (PoE) 7280 W maximum in combined mode (PoE)
DC-input terminal block	Accepts 10 to 12 AWG size copper wire. The actual size of the wire needed is determined by the installer or the local electrician. Terminal block material is rated at 150°C
Output holdup time	4 ms
Heat dissipation	159 BTUs/hr (data) 2905 BTUs/hr (data and voice)

Table A-11 list the 1400 W DC-input power supply LEDs and their meanings.

Table A-11 1400 W DC-Input Power Supply LEDs

LED	Meaning
INPUT OK	<ul style="list-style-type: none"> Green—Source DC voltage is OK. (Input voltage is -40.5 VDC or greater.) Off—Source DC voltage falls below -33 VDC, is not present, or the power supply is turned off.
FAN OK	<ul style="list-style-type: none"> Green—Power supply fan is operating properly. Off—Power supply fan failure is detected.
OUTPUT FAIL	<ul style="list-style-type: none"> Red—Problem with one or more of the DC-output voltages of the power supply is detected. Off—DC-output voltage with acceptable margins.
In-line PWR	<ul style="list-style-type: none"> Green—48 VDC passthrough output voltage is enabled and is greater than -39 VDC and less than -60 VDC. Off—Indicates any of the following: <ul style="list-style-type: none"> Passthrough breakers are not enabled DC input is less than -40.5 VDC One or more -48 VDC outputs is less than -39 VDC Amber—Passthrough breakers are enabled and input voltage exceeds -60 VDC

Table A-12 lists the chassis specific power usage numbers for the 1400 W DC-input power supply.

Table A-12 Chassis-Specific Power Usage

Chassis	Maximum Draw (W)	Maximum Input (W)	Current	Heat Dissipation (BTUs)
Catalyst 4503 specific power usage (data only)	475	633	<ul style="list-style-type: none"> 15.6 A @ -40.5 VDC (min) 8.8 A @ -72 VDC (max) 	2160
Catalyst 4506 specific power usage (data only)	850	1133	<ul style="list-style-type: none"> 28 A @ -40.5 VDC (min) 15.8 A @ -72 VDC (max) 	3515
Catalyst 4507R-E specific power usage (data only)	1080	1440	<ul style="list-style-type: none"> 35.6 A @ -40.5 VDC (min) 20 A @ -72 VDC (max) 	4910

1400 W Triple-Input DC-Input Power Supply

The 1400 W triple-input DC-input power supply (PWR-C45-1400DC), shown in [Figure A-5](#), is supported in the following Catalyst 4500 E-series switches.

- Catalyst 4503-E
- Catalyst 4506-E
- Catalyst 4507R-E
- Catalyst 4510R-E
- Catalyst 4507R+E
- Catalyst 4510R+E

Figure A-5 1400 W Triple-Input DC-Input Power Supply

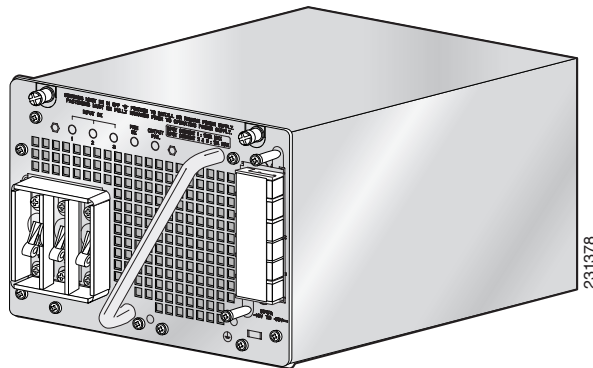

1400 W Triple Input DC-Input Power Supply Specifications

[Table A-13](#) lists the specifications for the 1400 W triple input DC-input power supply.

Table A-13 1400 W DC Triple-Input Power Supply Specifications

Item	Specification
DC-input voltage	<ul style="list-style-type: none"> • -48 VDC for nominal -48 V battery backup system (operating range: -40.5 VDC to -56 VDC) • -60 VDC for nominal -60 V battery backup system (operating range: -55 VDC to -72 VDC)
DC-input current	<ul style="list-style-type: none"> • 42.5 A maximum @ -48 VDC input • Input 1—12.5 A @ -48 to -60 VDC • Input 2—15 A @ -48 to -60 VDC • Input 3—15 A @ -48 to -60 VDC
Power supply output capacity	<ul style="list-style-type: none"> • 1721 W—42.5 A @ -40.5 VDC (min voltage) • 1800 W—25 A @ -72 VDC (max voltage)

Table A-13 1400 W DC Triple-Input Power Supply Specifications (continued)

Item	Specification
Power supply output	<ul style="list-style-type: none"> 8 A (min) to 115.3 A (max) @ +12 VDC 1.2 A (min) to 12.5 A (max) @ +3.3 VDC 1360 W+ 40 W redundant mode 2450 W maximum in combined mode
DC input terminal block	Accepts 10 to 12 AWG size copper wire. The actual size of the wire needed is determined by the installer or the local electrician. Terminal block material is rated at 302°F (150°C)
Output holdup time	8 ms
Maximum kVA rating ¹	1.77 kVA (1400 W load)
Max heat dissipation	1269 BTUs/hr
Minimum software requirement	Cisco IOS Release 12.2(25)EW
Power over Ethernet	Not supported
Catalyst 4503-E Specific Power Usage (data only)	Two modules minimum required @ -40.5 VDC input One 15 A module minimum required @ -44 VDC input
Maximum draw	475 W
Maximum input	609 W total / # of modules = W per module
Current draw at -40.5 V (min voltage)	15 A total / # of modules = Amperes per module
Current draw at -72 V (max voltage)	8.5 A total / # of modules = Amperes per module
Max heat dissipation at 609 W	2078 BTUs
Catalyst 4506-E Specific Power Usage (data only)	Two modules minimum required @ -44 VDC input Three modules minimum required @ -40.5 VDC input
Maximum draw (data only)	850 W
Maximum input	1076 W total / # of modules = W per module
Current draw at -40.5 V (min voltage)	26.6 A total / # of modules = Amperes per module
Current draw at -72 V (max voltage)	15 A total / # of modules = Amperes per module
Max heat dissipation at 1076 W	3671 BTUs
Catalyst 4507R-Specific Power Usage (data only)	Three modules minimum required
Maximum draw (data only)	1080 W
Max input is 1080 W	1367 W total / # of modules = W per module

Table A-13 1400 W DC Triple-Input Power Supply Specifications (continued)

Item	Specification
Current draw at –40.5 V (min voltage)	33.75 A total / # of modules = Amperes per module
Current draw at –72 V (max voltage)	19 A total / # of modules = Amperes per module
Max heat dissipation 1367 W	4665 BTUs

- The kVA rating listed for the power supply should be used as the sizing criteria for both UPS outputs as well as standard circuits and transformers to power a switch.

Table A-14 list the 1400 W triple-input DC-input power supply LEDs and their meanings.

Table A-14 1400 W DC Triple-Input DC-Input Power Supply LEDs

LED	Meaning
INPUT OK	<ul style="list-style-type: none"> Green—Source DC voltage is OK. (Input voltage is –40.5 VDC or greater.) Off—Source AC voltage falls below –33 VDC, is not present, or the power supply is turned off.
FAN OK	<ul style="list-style-type: none"> Green—Power supply fan is operating properly. Off—Power supply fan failure is detected.
OUTPUT FAIL	<ul style="list-style-type: none"> Red—Problem with one or more of the DC-output voltages of the power supply is detected. Off—DC-output voltage with acceptable margins. <p>Note For proper operation of the OUTPUT FAIL LED, systems with single power supplies must be configured with a minimum of one fan tray assembly and one supervisor engine. Systems with dual power supplies must have a minimum configuration of one fan tray assembly, one supervisor engine, and one additional module. Failure to meet these minimum configuration requirements can cause a false power supply output fail signal.</p>

Table A-15 lists the 1400 W triple-input DC-input power supply input modes and outputs.

Table A-15 1400 W DC Triple-Input Power Supply Input Modes and Output

Input Mode	Source DC Connections	Input Configuration	Maximum Total Output Power
1	1	1 x 12.5 A	386 W @ –40.5 VDC 412 W @ –44.0 VDC
2	2 or 3	1 x 15 A	466 W @ –40.5 VDC 495 W @ –44.0 VDC
3	1, 2 or 3	1 x 12.5 A and 1 x 15 A	845 W @ –40.5 VDC 908 W @ –44.0 VDC

Table A-15 1400 W DC Triple-Input Power Supply Input Modes and Output (continued)

Input Mode	Source DC Connections	Input Configuration	Maximum Total Output Power
4	2, 3	2 x 15 A	914 W @ -40.5 VDC 990 W @ -44.0 VDC
5	1, 2, 3	1 x 12.5 A and 2 x 15 A	1294 W @ -40.5 VDC 1400 W @ -44.0 VDC

Power output also depends on whether two supplies are used, and whether they are in redundant or combined mode. [Table A-16](#) provides a matrix of possible outputs in combined mode depending on the power provided to the supply.

Table A-16 Maximum Power with Two 1400 W DC Triple-Input Power Supplies in Combined Mode

	PS2 input 1	PS2 input 2 or 3	PS2 input 1 and (2 or 3)	PS2 input 2 and 3	PS2 input 1 and 2 and 3
PS1 input 1	824 W	907 W	1320 W	1400 W	1700 W
PS1 input 2 or 3	907 W	990 W	1400 W	1450 W	1750 W
PS1 input 1 and (2 or 3)	1320 W	1400 W	1700 W	1750 W	1900 W
PS1 input 2 and 3	1400 W	1450 W	1750 W	1820 W	2130 W
PS1 input 1 and 2 and 3	1700 W	1750 W	1900 W	2130 W	2450 W

1400 W DC Triple-Input Power Supply Operational Modes

The 1400 W triple-input DC-input power supply (data only) allows added redundancy by providing terminals for two DC inputs rated at 15 A and one rated at 12.5 A per power supply.

This power supply has five operational modes depending on the inputs receiving power. When all three inputs are active, at input voltages greater than -44.0 V DC, the power supply delivers 1400 W maximum total output. [Table A-17](#) provides output information for these modes, given a single supply.

Table A-17 *Input Modes*

Input Mode	Input Number	Input Configuration	Maximum Total Output Power
1	1	1 x 12.5 A	386 W @ -40.5 VDC 412 W @ -44.0 VDC
2	2 OR 3	1 x 15 A	466 W @ -40.5 VDC 495 W @ -44.0 VDC
3	1, 2 OR 3	1 x 12.5 A and 1 x 15 A	845 W @ -40.5 VDC 908 W @ -44.0 VDC
4	2, 3	2 x 15A	914 W @ -40.5 VDC 990 W @ -44.0 V DC
5	1, 2, 3	1 x 12.5A and 2 x 15 A	1294 W @ -40.5 VDC 1400 W @ -44.0 VDC

The maximum total input current is 42.5 A and the maximum ambient temperature is 55 C. To determine the total maximum input power to a supply, add up the active individual module input power ratings. [Table A-18](#) provides output information for these modes, given two supplies working in combined mode. [Table A-19](#) provides output information for these modes, given two supplies working in redundant mode.

Table A-18 *Combined Mode Power Supply Configuration
(2450 W Max Output Power)*

Input Number	Maximum Input Current	Maximum Input Power @ -44 VDC
1	12.5 A @ -44 VDC	550 W
2	15 A @ -44 VDC	660 W
3	15 A @ -44 VDC	660 W

**Table A-19 Dual Redundant Mode Power Supply Configuration
(1400 W Max Output Power)**

Input Number	Approximate Input Current	Approximate Input Power @ -40.5 VDC	Approximate Input Power @ -44 VDC
1	6.25 A @ -40.5 / -44 VDC	253 W	275 W
2	7.5 A @ -40.5 / -44 VDC	304 W	330 W
3	7.5 A @ -40.5 / -44 VDC	304 W	330 W

**Note**

In a redundant configuration with all inputs supplied, there must be a 100 W minimum system load or the OUTPUT FAIL LED shows a false failure.

The 1400 W triple-input DC-input power supply requires a minimum draw from the system that it is installed in. [Table A-20](#) shows the minimum draw for the possible modes.

Table A-20 Minimum Load Table

	PSU1			PSU2			12 VDC Minimum Load	3.3 VDC Minimum Load
	Input 1	Input 2	Input 3	Input 1	Input 2	Input 3		
Single Operation								
Mode 1	ON	OFF	OFF	—	—	—	1.33 A	0.6 A
Mode 2	OFF	ON	OFF	—	—	—	1.33 A	0.6 A
	OFF	OFF	ON	—	—	—	1.33 A	0.6 A
Mode 3	ON	ON	OFF	—	—	—	2.66 A	0.6 A
	ON	OFF	ON	—	—	—	2.66 A	0.6 A
Mode 4	OFF	ON	ON	—	—	—	2.66 A	0.6 A
Mode 5	ON	ON	ON	—	—	—	4 A	0.6 A
Dual Redundant Operation								
Mode 1	ON	OFF	OFF	ON	OFF	OFF	2.66 A	1.2 A
Mode 2	OFF	ON	OFF	OFF	ON	OFF	2.66 A	1.2 A
	OFF	OFF	ON	OFF	OFF	ON	2.66 A	1.2 A
Mode 3	ON	ON	OFF	ON	ON	OFF	5.32 A	1.2 A
	ON	OFF	ON	ON	OFF	ON	5.32 A	1.2 A
Mode 4	OFF	ON	ON	OFF	ON	ON	5.32 A	1.2 A
Mode 5	ON	ON	ON	ON	ON	ON	8 A	1.2 A

2800 W AC-Input Power Supply

The 2800 W AC-input power supply (PWR-C45-2800ACV), shown in [Figure A-3](#), is supported in the following Catalyst 4500 E-series switches:

- Catalyst 4503-E
- Catalyst 4506-E
- Catalyst 4507R-E
- Catalyst 4510R-E
- Catalyst 4507R+E
- Catalyst 4510R+E

Figure A-6 2800 W AC-Input Power Supply

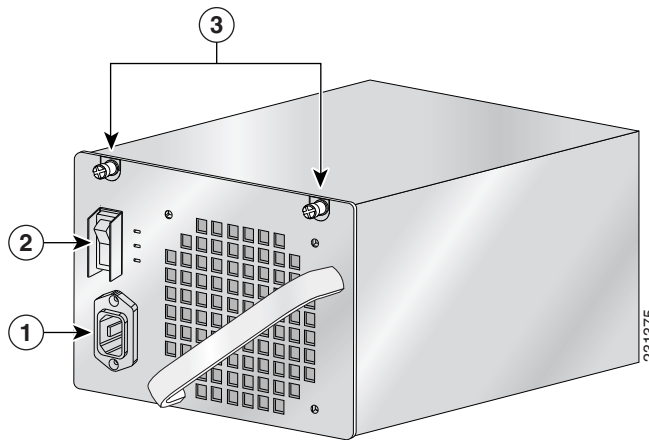

1	AC-in receptacle	3	Captive installation screws
2	On/off power switch		

2800 W AC-Input Power Supply Specifications

[Table A-21](#) lists the specifications for the 2800 W AC-input power supply.

Table A-21 2800 W AC-Input Power Supply Specifications

Item	Specification
AC-input type	Autoranging input with power factor corrector
AC-input voltage	200 to 240 VAC ($\pm 10\%$ for full range)
AC-input current	16 A maximum at 200 VAC
AC-input frequency	50/60 Hz (nominal) ($\pm 3\%$ for full range)

Table A-21 2800 W AC-Input Power Supply Specifications (continued)

Item	Specification
Branch circuit requirement	<p>Each chassis power supply should have its own dedicated, fused-branch circuit:</p> <ul style="list-style-type: none"> • For North America—15 A or 20 A • For International—Circuits sized to local and national codes • All Catalyst 4500 E-series AC-input power supplies require single-phase source AC. • All AC power supply inputs are fully isolated. <ul style="list-style-type: none"> – Source AC can be out of phase between multiple power supplies in the same chassis, which means that PS1 can be operating from phase A and PS2 can be operating from phase B. – For high-line operation, the power supply operates with the hot conductor wired to a source AC phase and the neutral conductor wired either to ground or to another source AC phase as long as the net input voltage is in the range of 170 to 264 VAC. – Source AC can be out of phase between AC inputs on power supplies that are equipped with multiple AC inputs, which means that power cord 1 can be plugged into phase A and power cord 2 can be plugged into phase B.
Power supply output capacity	<p>2800 W maximum</p> <p>1360 W+ 40 W redundant mode (data)</p> <p>2473 W maximum in combined mode (data)</p> <p>1400 W maximum each in redundant mode (PoE)</p> <p>2333 W maximum in combined mode (PoE)</p>
Power supply output	<ul style="list-style-type: none"> • 113.3 A @ 12 VDC (data) • 12.1 A @ 3.3 VDC (data) • 28 A @ -50 VDC (PoE)
Output holdup time	20 ms minimum
Maximum kVA rating	3.52 kVA
Max heat dissipation	2387 BTUs/hr.
Minimum software requirement	Cisco IOS Release 12.1(13)EW
Power over Ethernet	Supported, up to 1400 W (240 Cisco phones in combined mode)

Table A-22 describes the 2800 W AC-input power supply LEDs and their meanings.

Table A-22 2800 W AC-Input Power Supply LEDs

LED	Color/State	Description
INPUT OK	Green	Indicates whether the input voltage is within the required range: Input voltage is within the required range.
	Flashing	Input voltage is present, but is below required range.
	Off	Input voltage is below the required range or the power supply is off.
OUTPUT FAIL	Red	Output voltage is not within the specified range.
	Off	Output voltage is within the specified range.
FAN OK	Green	Indicates the status of the power supply fans: The fans are operational.
	Off	The fans are not operational.

2800 W Power Supply AC Power Cords

Table A-23 lists the specifications for the AC power cords that are available for the 2800 W AC-input power supply.

Note

All 2800 W AC-input power supply power cords have an IEC60320/C19 appliance plug at one end.

Table A-23 2800 W AC-Input Power Supply Power Cords

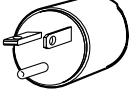
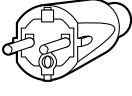
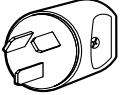
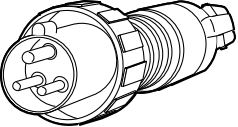
Locale	Power Cord Part Number	Length	Cordset Rating	AC Source Plug Type
Japan, North America (locking) 200–240 VAC operation	CAB-AC-2800W-TWLK=	13.6 ft (4.1 m)	16 A, 250 VAC	NEMA L6-20  120361
Japan, North America (nonlocking) 200–240 VAC operation	CAB-AC-2800W-6-20	13.2 ft (4.0 m)	16 A, 250 VAC	NEMA 6-20 non-locking  120355
Europe	CAB-AC-2800W-EU=	13.2 ft (4.0 m)	16 A, 250 VAC	CEE 7/7  120357
Argentina	CAB-IR2073-C19-AR= (was CAB-7513ACR=)	14 ft (4.3 m)	16 A, 250 VAC	IRAM 2073  120356
International	CAB-AC-2800W-INT=	13.6 ft (4.1 m)	16 A, 250 VAC	IEC 309  120360

4200 W AC-Input Power Supply

The 4200 W AC-input power supply (PWR-C45-4200ACV), shown [Figure A-7](#), is supported in the following Catalyst 4500 E-series switches:

- Catalyst 4503-E
- Catalyst 4506-E
- Catalyst 4507R-E
- Catalyst 4510R-E
- Catalyst 4507R+E
- Catalyst 4510R+E

Figure A-7 4200 W AC-Input Power Supply

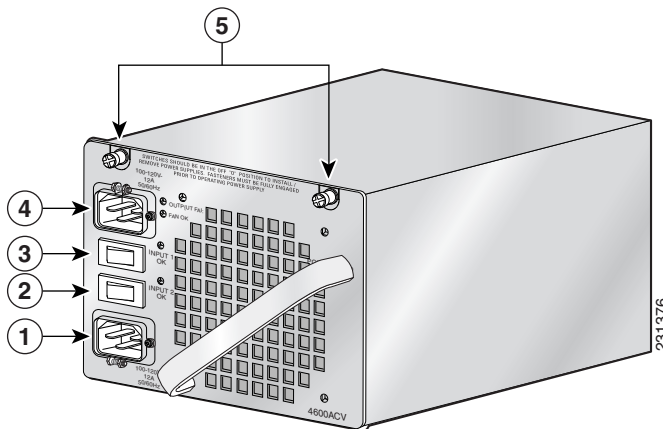

1	AC-input 2 receptacle	4	AC-input 1 receptacle
2	AC-input 2 power on/off switch	5	Captive installation screws
3	AC-input 1 power on/off switch		

4200 W AC-Input Power Supply Specifications

[Table A-24](#) lists the specifications for the 4200 W AC-input power supply.

Table A-24 4200 W AC-Input Power Supply Specifications

Item	Specification
AC-input type	Autoranging input with power factor corrector Note Power factor correction is a standard feature on all Catalyst 4500 E-series AC-input power supplies. PFC reduces the reactive component in the source AC current allowing higher power factors (typically 99 percent or better) and lower harmonic current components.
AC-input voltage	<ul style="list-style-type: none"> • Low-line (120 VAC nominal)—85 VAC (min) to 132 VAC (max) • High-line (230 VAC nominal)—170 VAC (min) to 264 VAC (max)
AC-input current	12 A (maximum) @ 120 VAC or 230 VAC for each input
AC-input frequency	50/60 Hz (nominal) ($\pm 3\%$ for full range)
Branch circuit requirement	Each chassis power supply should have its own dedicated, fused-branch circuit: <ul style="list-style-type: none"> • For North America—15 A or 20 A • For International—Circuits sized to local and national codes • All Catalyst 4500 E-series AC-input power supplies require single-phase source AC. • All AC power supply inputs are fully isolated. <ul style="list-style-type: none"> – Source AC can be out of phase between multiple power supplies in the same chassis, which means that PS1 can be operating from phase A and PS2 can be operating from phase B. – For high-line operation, the power supply operates with the hot conductor wired to a source AC phase and the neutral conductor wired either to ground or to another source AC phase as long as the net input voltage is in the range of 170 to 264 VAC. – Source AC can be out of phase between AC inputs on power supplies that are equipped with multiple AC inputs, which means that power cord 1 can be plugged into phase A and power cord 2 can be plugged into phase B.

Table A-24 4200 W AC-Input Power Supply Specifications (continued)

Item	Specification
Power supply output capacity	<p>The power supply output capacity is dependent on the number of AC power cords (1 or 2) attached, the source AC voltage (110 VAC [low-line] or 220 VAC [high-line] applied to the power supply inputs, and the number of power supply power switches switched on or off.</p> <p>Note If source AC is applied to both two inputs, both inputs should have the same AC voltage.</p>
1050 W operation	<p>1050 W maximum with the following combinations of power cords and source AC voltage applied to the power supply inputs:</p> <ul style="list-style-type: none"> One AC input is connected to low-line (110 VAC nominal); the second AC input is not connected to source AC or is switched off.
2100 W operation	<p>2100 W maximum with the following combinations of power cords and source AC voltage applied to the power supply inputs:</p> <ul style="list-style-type: none"> Both AC inputs are connected to low-line (110 VAC nominal) and both inputs are switched on. One AC input connected to high-line (220 VAC nominal); the second AC input is not connected or is switched off.
4200 W operation	<p>4200 W maximum with the following combinations of power cords and source AC voltage applied to the power supply inputs:</p> <ul style="list-style-type: none"> Both AC inputs are connected to high-line (220 VAC nominal) and both inputs are switched on.
Power supply output	<ul style="list-style-type: none"> 1050 W operation (with one 110 VAC nominal input) <ul style="list-style-type: none"> 55.9 A @ 12 V (data only) 12.5 A @ 3.3 V (data only) 14.6 A @ -50 V (PoE if used) 2100 W operation (with two 110 VAC nominal inputs) <ul style="list-style-type: none"> 115.3 A @ 12 V (data only) 12.5 A @ 3.3 V (data only) 38.0 A @ -50 V (PoE if used) 2100 W operation (with one 220 VAC nominal input) <ul style="list-style-type: none"> 115.3 A @ 12 V (data only) 12.5 A @ 3.3 V (data only) 38.5 A @ -50 V (PoE if used) 4200 W operation (with two 220 VAC nominal inputs) <ul style="list-style-type: none"> 115.3 A @ 12 V (data only) 12.5 A @ 3.3 V (data only) 77.1 A @ -50 V (PoE if used)
Output holdup time	20 ms minimum
Maximum kVA rating	5.25 kVA

Table A-24 4200 W AC-Input Power Supply Specifications (continued)

Item	Specification
Max heat dissipation	3583 BTUs/hr.
Minimum software requirement	Cisco IOS Release 12.2(25)EWA
Power over Ethernet	Supported, up to 4200 W

Table A-25 describes the 4200 W AC-input power supply LEDs and their meanings.

Table A-25 4200 W AC-Input Power Supply LEDs

LED	Color/State	Description
INPUT OK		Indicates whether the input voltage is within the required range:
	Green	Input voltage is within the required range.
	Flashing	Input voltage is present, but is below required range.
	Off	Input voltage is below the required range or the power supply is off.
OUTPUT FAIL	Red	Output voltage is not within the specified range.
	Off	Output voltage is within the specified range.
FAN OK	Green	Indicates the status of the power supply fans: The fans are operational.
	Off	The fans are not operational.

**Note**

The 4200 W AC power supply should not be used in mixed-voltage configurations. All the inputs in a chassis must be at the same voltage (110 VAC or 220 VAC).

Table A-26 shows the wattage output possible from a 4200 W power supply in redundant mode. In redundant mode, the two power supplies must have the same number of inputs and all inputs must be the same voltage. If the input voltages to the power supplies are mismatched, choose the value matching the weaker of the two power supplies.

Table A-26 Redundant Mode Output

Source AC to Power Supplies	+12 VDC	+3.3 VDC	-50 VDC	Total (W)
110 VAC to one input on supply 1 and one 100 VAC to one input on power supply 2	660 W	40 W	700 W	1050 W
110 VAC to both inputs on power supply 1 and 110 VAC to both inputs on power supply 2, or one 220 VAC input to power supply 1 and one 220 VAC input to power supply 2	1360 W	40 W	1850 W	2100 W
220 VAC to both inputs on power supply 1 and power supply 2	1360 W	40 W	3700 W	4200 W

Table A-27 shows the maximum output wattage with two 4200 W AC-input power supplies operating in combined mode.

Table A-27 4200 W Power Supplies in Combined Mode Output

Source AC to Power Supplies	W @ +12 VDC	W @ +3.3 VDC	W @ -50 VDC	Maximum (W)
Both power supplies with one input at 110 VAC	1200 W	40 W	1320 W	1870 W
One 110 VAC input to one power supply and two 110 VAC inputs to the other power supply	1800 W	40 W	2000 W	2730 W
Both power supplies with two 110 VAC inputs	2200 W	40 W	3100 W	3800 W
Both power supplies with one 220 VAC input	2200 W	40 W	3100 W	3800 W
Two 220 VAC inputs to one power supply, one 220 VAC input to the other power supply	2200 W	40 W	4700 W	5500 W
Both power supplies with two 220 VAC inputs	2200 W	40 W	6200 W	7600 W

4200 W Power Supply AC Power Cords

Table A-28 lists the specifications for the AC power cords that are available for the 4200 W AC-input power supply.



Note

All 4200 W power supply power cords have an IEC60320/C19 appliance plug at one end.

Table A-28 4200 W AC-Input Power Supply Power Cords





Locale	Power Cord Part Number	Length	Cordset Rating	AC Source Plug Type
Japan, North America 120 VAC operation	CAB-US515P-C19-US	9.8 ft (2.98 m)	15 A, 125 VAC	NEMA 5-15P  120354
Japan, North America (locking) 200–240 VAC operation	CAB-L620P-C19-US	14 ft (4.2 m)	20 A, 250 VAC	NEMA L6-20  120361
Japan, North America (nonlocking) 200–240 VAC operation	CAB-US620P-C19-US	13.2 ft (4.02 m)	20 A, 250 VAC	NEMA 6-20 non-locking  120355
Europe	CAB-CEE77-C19-EU	13.2 ft (4.0 m)	15 A, 250 VAC	CEE 7/7  120357
International (including Argentina and South Africa)	CAB-I309-C19-INT	13.6 ft (4.1 m)	16 A, 250 VAC	IEC 309  120360
Australia	CAB-A3112-C19-AUS	14 ft (4.3 m)	15 A, 250 VAC	AS/NZS 3112  120356
Argentina (was CAB-7513ACR=)	CAB-IR2073-C19-AR= (was CAB-7513ACR=)	14 ft (4.3 m)	10 A, 250 VAC	IRAM 2073  120356
Italy	CAB-C2316-C19-IT	14 ft (4.3 m)	16 A, 250 VAC	CEI 23-16  120358
United Kingdom	CAB-BS1363-C19-UK	14 ft (4.3 m)	13 A, 250 VAC	BS 1363  120359

Table A-28 4200 W AC-Input Power Supply Power Cords (continued)

Locale	Power Cord Part Number	Length	Cordset Rating	AC Source Plug Type
Israeli	CAB-S132-C19-ISRL	14 ft (4.3 m)	16 A, 250 VAC	SI32  130922
UPS 220V	CAB-C19-CBN	9 ft (2.74 m)	20 A, 250 VAC	IEC-60320-C20  130923

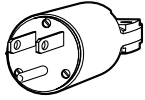
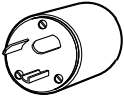
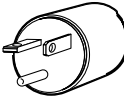
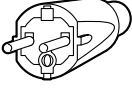
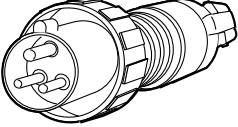
6000 W AC-Input Power Supply

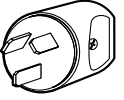
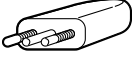
The 6000 W AC-input power supply (PWR-C45-6000ACV), shown in [Figure A-8](#), is supported in following Catalyst 4500 E-series switch chassis:

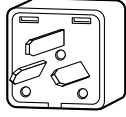
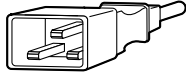
- Catalyst 4503-E
- Catalyst 4506-E
- Catalyst 4507R-E
- Catalyst 4510R-E
- Catalyst 4507R+E
- Catalyst 4510R+E

Figure A-8 6000 W Dual-Input AC Power Supply

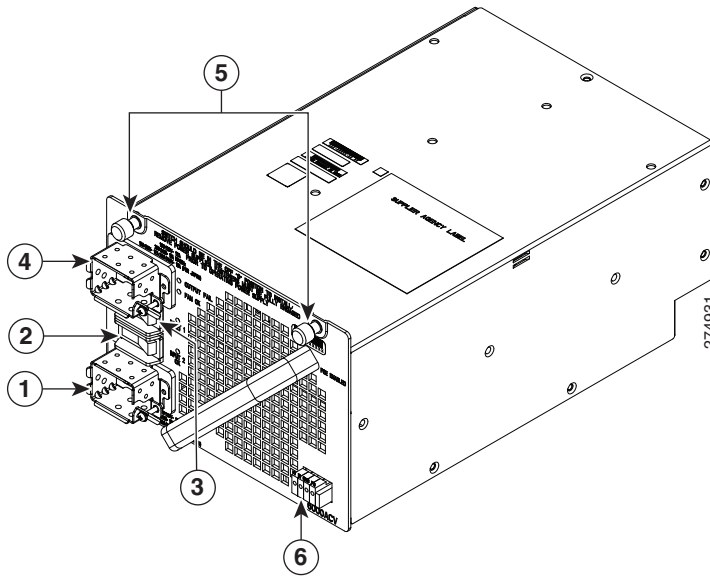

1	AC-input 2 receptacle	4	AC-input 1 receptacle
2	AC-input 2 on switch	5	Captive screws
3	AC-input 1 on switch	6	Remote power cycling terminal

6000 W Power Supply Specifications

Table A-29 lists the specifications for the 6000 W AC-input power supplies.

Table A-29 6000 W AC-Input Power Supply Specifications

Item	Specification
AC-input type	Autoranging inputs with power factor correction Note Power factor correction is a standard feature on all Catalyst 4500 E-series AC-input power supplies. PFC reduces the reactive component in the source AC current allowing higher power factors (typically 99 percent or better) and lower harmonic current components.
AC-input voltage	<ul style="list-style-type: none"> Low-line (120 VAC nominal)—85 VAC (min) to 132 VAC (max) High-line (230 VAC nominal)—170 VAC (min) to 264 VAC (max)
AC-input current	<ul style="list-style-type: none"> 12 A (max) @ 120 VAC (for each input) 16 A (max) @ 230 VAC (for each input)
AC-input frequency	50/60 Hz (nominal) ($\pm 3\%$ for full range)

Table A-29 6000 W AC-Input Power Supply Specifications

Item	Specification
Power supply output	<p>Total output depends on the number of inputs connected and the source AC voltage. If two inputs are used, they should both be of the same AC voltage.</p> <ul style="list-style-type: none"> • 1050 W operation (with one 120 VAC nominal input) <ul style="list-style-type: none"> – 70.8 A @ 12 VDC (data only) – 12.5 A @ 3.3 VDC (data only) – 18.4 A @ –50 VDC (PoE if used) • 2100 W operation (with two 120 VAC nominal inputs) <ul style="list-style-type: none"> – 141.6 A @ 12 VDC (data only) – 12.5 A @ 3.3 VDC (data only) – 37.0 A @ –50 VDC (PoE if used) • 3000 W operation (with one 230 VAC nominal input) <ul style="list-style-type: none"> – 183.3 A @ 12 VDC (data only) – 12.5 A @ 3.3 VDC (data only) – 48 A @ –50 VDC (PoE if used) • 6000 W operation (with two 230 VAC nominal inputs) <ul style="list-style-type: none"> – 183.3 A @ 12 VDC (data only) – 12.5 A @ 3.3 VDC (data only) – 96 A @ –50 VDC (PoE if used)
Power supply output capacity	6000 W maximum
Output holdup time	20 ms minimum
kVA rating ¹	6.8 kVA (power factor = 0.99)
Heat dissipation	2,720 BTUs/hr (approx.)
Minimum software requirement	Cisco IOS Release 12.2(52)SG
Power over Ethernet	Supported, up to 4800 W

1. The kVA rating listed for the power supply should be used as the sizing criteria for both UPS outputs as well as standard circuits and transformers to power a switch.

Table A-30 list the 6000 W AC-input power supply LEDs and their meanings.

Table A-30 6000 W AC-input Power Supply LEDs

LED	Meaning
INPUT OK	<ul style="list-style-type: none"> Green—Source AC voltage is OK. (Input voltage is 85 VAC or greater.) Off—Source AC voltage falls below 70 VAC, is not present, or the power supply is turned off.
FAN OK	<ul style="list-style-type: none"> Green—Power supply fan is operating properly. Off—Power supply fan failure is detected.
OUTPUT FAIL	<ul style="list-style-type: none"> Red—Problem with one or more of the DC-output voltages of the power supply is detected. Off—DC-output voltage with acceptable margins. <p>Note For proper operation of the OUTPUT FAIL LED, systems with single power supplies must be configured with a minimum of one fan tray assembly and one supervisor engine. Systems with dual power supplies must have a minimum configuration of one fan tray assembly, one supervisor engine, and one additional module. Failure to meet these minimum configuration requirements can cause a false power supply output fail signal.</p>

**Note**

The 6000 W AC-input power supply should not be used in mixed-voltage configurations. All the inputs in a chassis must be at the same voltage (110 VAC or 220 VAC).

Table A-31 shows the wattage output possible from a 6000 W AC-input power supply in redundant mode. In redundant mode, two power supplies must have identical inputs and all inputs must be at the same voltage. If the input voltages are mismatched, choose the value matching the weaker of the two power supplies.

Table A-31 Redundant Mode Output

	12 VDC	3.3 VDC	-50 VDC	Total
110 VAC to a single input on both supplies	850 W	40 W	922 W	1050 W
110 VAC to both inputs on both supplies	1700 W	40 W	1850 W	2100 W
220 VAC input to one input on both supplies	2200 W	40 W	2400 W	3000 W
220 VAC to both inputs on both supplies	2200 W	40 W	4600 W	6000 W

Table A-32 shows the maximum output wattage with two 6000 W AC-input power supplies in combined mode.

Table A-32 Combined Mode Output

	W @ 12 VDC	W @3.3 VDC	W @ -50 VDC	Maximum (W)
Both PS with one input at 110 VAC	1400 W	40 W	1670 W	1710 W
One 110 VAC input to one PS, two 110 VAC inputs to the other PS	2360 W	40 W	2560 W	2800 W
Both PS with two 110 VAC inputs	3090 W	40 W	3360 W	3700 W
Both PS with one 220 VAC input	4000 W	40 W	4360 W	5400 W
Two 220 VAC inputs to one PS, one 220 VAC input to the other PS	4000 W	40 W	6600 W	6200 W
Both PS with two 220 VAC inputs	4000 W	40 W	8700 W	10900 W

6000 W Power Supply AC Power Cords

Table A-33 lists the specifications for the AC power cords that are available for the 6000 W AC-input power supply. The table includes references to power cord illustrations.

Note

All 6000 W AC-input power supply power cords have an IEC60320/C19 appliance plug at one end.

Table A-33 6000 W AC-Input Power Supply Power Cords

Locale	Power Cord Part Number	Length	Cordset Rating	AC Source Plug Type
Japan, North America 120 VAC operation	CAB-US515P-C19-US	9.8 ft (2.98 m)	15 A, 125 VAC	NEMA 5-15P  120354
Japan, North America (nonlocking) 200–240 VAC operation	CAB-US620P-C19-US	13.2 ft (4.02 m)	20 A, 250 VAC	NEMA 6-20 non-locking  120355
Europe	CAB-AC-2800W-EU= CAB-CEE77-C19-EU=	13.2 ft (4.0 m)	16 A, 250 VAC	CEE 7/7  120357
International	CAB-AC-2800W-INT= CAB-I309-C19-INT=	13.6 ft (4.1 m)	20 A, 250 VAC	IEC 309  120360

Table A-33 6000 W AC-Input Power Supply Power Cords (continued)





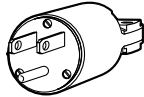
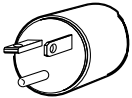
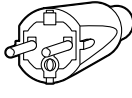
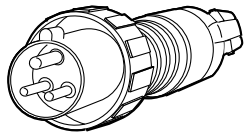

Locale	Power Cord Part Number	Length	Cordset Rating	AC Source Plug Type
Japan, North America (locking) 200–240 VAC operation	CAB-AC-2800W-TWLK= CAB-L620P-C19-US=	13.6 ft (4.1 m)	16 A, 250 VAC	NEMA L6-20  120361
Australia	CAB-AC-16A-AUS CAB-A3112-C19-AUS=	14 ft (4.3 m)	16 A, 250 VAC	AU20S3  275667
Argentina	CAB-IR2073-C19-AR=	14 ft (4.3 m)	16 A, 250 VAC	IRAM 2073  120356
China 200–240 VAC operation	CAB-9K16A-CH	14 ft (4.3 m)	16 A, 250 VAC	GB16C  275664
Switzerland	CAB-ACS-16	8 ft (2.9 m)	16 A, 250 VAC	G23  275665
India	CAB-SABS-C19-IND	14 ft (4.3 m)	16 A, 250 VAC	SABS 164-1  275666
United Kingdom	CAB-AC-2800W-INT CAB-I309-C19-INT	14 ft (4.3 m)	16 A, 250 VAC	IEC 309  120360
Italy	CAB-C2316-C19-IT=	14 ft (4.3 m)	16 A, 250 VAC	CEI 23-16  120358

Table A-33 6000 W AC-Input Power Supply Power Cords (continued)

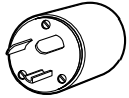
Locale	Power Cord Part Number	Length	Cordset Rating	AC Source Plug Type
Israel	CAB-S132-C19-ISRL=	14 ft (4.3 m)	16 A, 250 VAC	SI 16S3  130922
Brazil	CAB-EL224-C19-BR=	8 ft (2.9 m)	16 A, 250 VAC	NBR 14136  275665
UPS 220V	CAB-C19-CBN	9 ft (2.74 m)	20 A, 250 VAC	IEC-60320-C20  130923

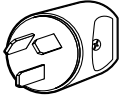
Remote Power Cycling Feature

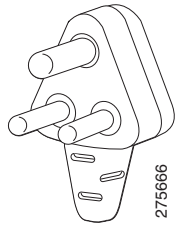
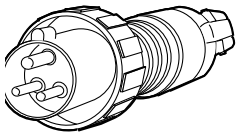
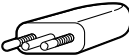
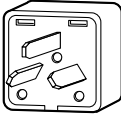
The 6000 W AC-input power supply is equipped with a remote power cycling feature that allows you to remotely turn on or turn off the power supply through an external relay controller box. [Figure A-9](#) shows a typical remote power on/off setup. A three-position terminal block, located on the lower right quadrant of the power supply faceplate, provides the interface to the external relay controller box. (See [Figure A-9](#).)

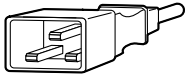
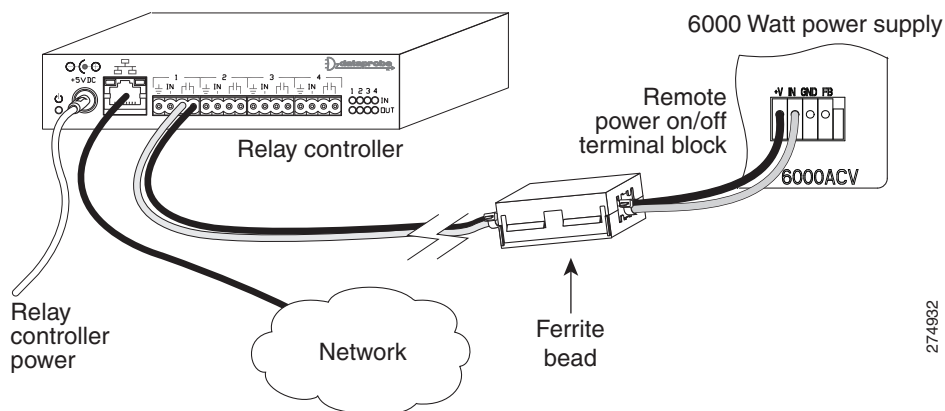
Figure A-9 Remote Power On/Off Feature Components

Terminal Block

The terminal block has four contacts labeled +V, IN, GND, and FB. Two control wires from an external relay controller box attach to either +V and IN or IN and GND. +V and IN are used when the relay controller box contains a normally-open (NO) type of relay. IN and GND are used when using an RS-232 interface.

Ferrite Bead

A plastic bag containing one ferrite bead and two 4-inch plastic ties is included with the 6000 W power supply AC power cords. The ferrite bead is a passive device that limits high-frequency interference on interface and control cables and is only required when you install the remote power-cycling feature that is supported by the 6000 W power supply. The ferrite bead is installed on the two control wires that come from the relay controller box to the terminal block on the 6000 W power supply. The ferrite bead should be installed as close as possible to the power supply terminal block for the bead to be effective. You do not need the ferrite bead for 6000 W power supply installations that do not include the remote power-cycling feature.

Remote Power-Cycling Operation

This feature allows you to remotely power cycle the Catalyst 4500 E-series switch using any appropriate third-party relay controller. This feature eliminates the need for you to have access to the supervisor engine console or CLI to control power cycling. [Table A-34](#) lists the relay controller box relay type, the corresponding power supply terminal block positions, and a description of the power-cycling operation.

Table A-34 6000 W Power Supply Relay Controller Switch Settings and Operation

External Relay Controller Box Relay Type	Power Supply Terminal Block Positions Used	Remote Power-Cycling Operation
Normally open (NO) relay.	The +V pin is internally pulled up to 12 VDC with a 10 K ohms pull up resistor, and pin IN is connected to the input pin (either pin 1, 4, 10, or 13) of the line receiver.	<ul style="list-style-type: none"> Power supply cycled from on to off. The power supply is powered off by energizing the relay (relay contacts go from open to closed) for more than 5 seconds. Power supply cycled from off to on. The power supply is powered on by reenergizing the relay (relay contacts go from closed to open) after a 10 second delay.
RS232 driver.	Pin IN is connected to the input pin (either pin 1, 4, 10, or 13) of the line receiver, and pin GND is connected to ground. A capacitor of 1 uF should be used between the line receiver input and the ground to bypass noise peaks.	<ul style="list-style-type: none"> Power supply cycles from on to off. The power supply is powered off by RS-232 logic HI for more than 5 seconds. Power supply cycles from off to on— The power supply is powered on by RS-232 logic LO after a 10 second delay.
No relay attached. Remote power-cycling feature not installed.	—	—

9000 W AC-Input Power Supply

The 9000 W AC-input power supply (PWR-C45-9000ACV), shown in [Figure A-10](#), is supported by the following Catalyst 4500 E-series switch chassis:

- Catalyst 4503-E
- Catalyst 4506-E
- Catalyst 4507R-E
- Catalyst 4510R-E
- Catalyst 4507R+E
- Catalyst 4510R+E

Figure A-10 9000 W AC_Input Power Supply Features

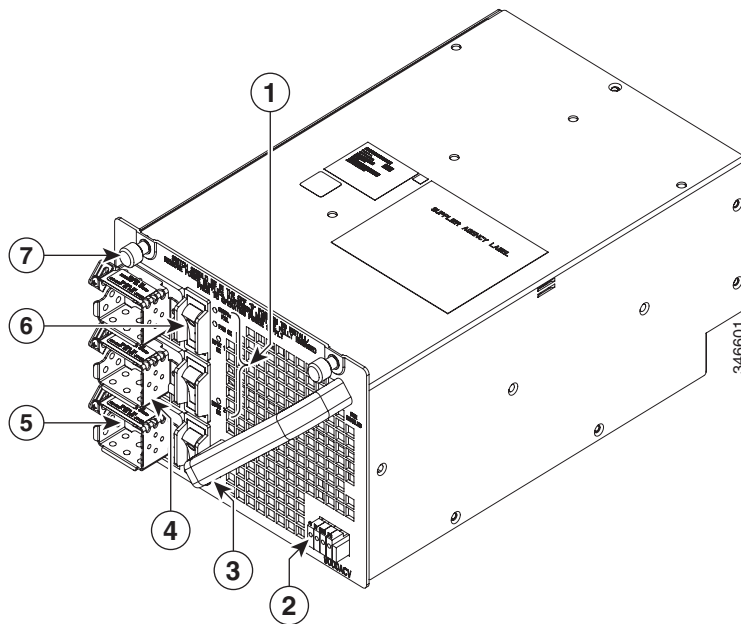

1	Power supply status LEDs	5	AC in connectors (IE60320/C20) (3 inputs)
2	Remote power cycling feature terminal block	6	AC power switches (3 switches)
3	Handle	7	Captive installation screws (2X)
4	Power cord connector retention clips		

9000 W Power Supply Specifications

Table A-35 lists the specifications for the 9000 W AC-input power supply.

Table A-35 9000 W AC-Input Power Supply Specifications

Item	Specification
AC-input type	<p>Autoranging inputs with power factor correction (PFC)</p> <p>Note PFC is a standard feature on all Catalyst 4500 E-series AC-input power supplies. PFC reduces the reactive component in the source AC current allowing higher power factors (typically 99 percent or better) and lower harmonic current components.</p>
AC-input voltage	<ul style="list-style-type: none"> • Low-line (120 VAC nominal)—85 VAC (min) to 132 VAC (max) • High-line (230 VAC nominal)—170 VAC (min) to 264 VAC (max) <p>Note Mixed voltage input mode operation is supported. However, with mixed voltage inputs, output power defaults to the triple 120 VAC output limits.</p>
AC-input current	<ul style="list-style-type: none"> • 12 A (max) @ 120 VAC (for each input) • 16 A (max) @ 230 VAC (for each input)
AC-input frequency	50/60 Hz (nominal) ($\pm 3\%$ for full range)
DC output voltages	<ul style="list-style-type: none"> • 12 VDC (11.8 VDC (min) to 12.2 VDC (max)) • 3.3 VDC (3.2 VDC (min) to 3.4 VDC (max)) • -50 VDC (-48 VDC (min) to -52 VDC (max))

Table A-35 9000 W AC-Input Power Supply Specifications (continued)

Item	Specification
Power supply output	<p>Total output power depends on the number of inputs connected and the available source AC voltage. If more than one input is used, all inputs be the same AC voltage (either high-line or low-line).</p> <p>Note Mixed voltage input mode operation is supported.</p> <ul style="list-style-type: none"> • 1100 W operation (with one 120 VAC nominal input) <ul style="list-style-type: none"> – 80 A @ 12 VDC (data only) – 12.5 A @ 3.3 VDC (data only) – 20 A @ –50 VDC (PoE if used) • 2200 W operation (with two 120 VAC nominal inputs) <ul style="list-style-type: none"> – 121.7 A @ 12 VDC (data only) – 12.5 A @ 3.3 VDC (data only) – 40 A @ –50 VDC (PoE if used) • 3300 W operation (with three 120 VAC nominal inputs) <ul style="list-style-type: none"> – 121.7 A @ 12 VDC (data only) – 12.5 A @ 3.3 VDC (data only) – 50 A @ –50 VDC (PoE if used) • 3000 W operation (with one 230 VAC nominal input) <ul style="list-style-type: none"> – 121.7 A @ 12 VDC (data only) – 12.5 A @ 3.3 VDC (data only) – 50 A @ –50 VDC (PoE if used) • 6000 W operation (with two 230 VAC nominal inputs) <ul style="list-style-type: none"> – 166.7 A @ 12 VDC (data only) – 12.5 A @ 3.3 VDC (data only) – 100 A @ –50 VDC (PoE if used) • 9000 W operation (with three 230 VAC nominal inputs) <ul style="list-style-type: none"> – 166.7 A @ 12 VDC (data only) – 12.5 A @ 3.3 VDC (data only) – 150 A @ –50 VDC (PoE if used)

Table A-35 9000 W AC-Input Power Supply Specifications (continued)

Item	Specification
Power supply output capacity	9000 W maximum
Output holdup time	20 ms minimum
kVA rating ¹	9680 kVA (power factor = 0.99)
Heat dissipation	3010 BTUs/hr (max.)
Minimum software requirement	Cisco IOS Release IOS-XE 3.4.0SG/15.1(2)SG
Power over Ethernet	Supported, up to 7500 W

1. The kVA rating listed for the power supply should be used as the sizing criteria for both UPS outputs as well as standard circuits and transformers to power a switch.

Table A-36 list the 9000 W AC-input power supply LEDs and their meanings.

Table A-36 9000 W AC-input Power Supply LEDs

LED	Meaning
INPUT 1 OK INPUT 2 OK INPUT 3 OK	<ul style="list-style-type: none"> Green—Source AC voltage is OK. (Input voltage is 85 VAC or greater.) Off—Source AC voltage falls below 70 VAC, source AC is not present, or the power supply is turned off. <p>Note For an AC input voltage that is between 70 VAC and 85 VAC, the INPUT OK LED condition is indeterminate; it can be either green, off, or flashing green.</p>
FAN OK	<ul style="list-style-type: none"> Green—Power supply fan is operating properly. Off—Power supply fan failure is detected.
OUTPUT FAIL	<ul style="list-style-type: none"> Red—Problem with one or more of the DC-output voltages of the power supply is detected. Off—DC-output voltage with acceptable margins. <p>Note For proper operation of the OUTPUT FAIL LED, systems with single power supplies must be configured with a minimum of one fan tray assembly and one supervisor engine. Systems with dual power supplies must have a minimum configuration of one fan tray assembly, one supervisor engine, and one additional module. Failure to meet these minimum configuration requirements can cause a false power supply output fail signal.</p>

System software detects how many of the source AC input lines on the power supply are powered and at what voltage (low-line or high-line) they are operating at. In addition, the 12 VDC and the -50 VDC output lines are monitored allowing total output power to be determined.

In redundant mode, the switch uses one power supply as the primary supply and the second power supply as a backup. If the primary power supply fails, the second power supply immediately supports the switch without disruption to the switch operation.

Table A-37 shows the wattage output possible from a 9000 W AC-input power supply operating in redundant mode.

Table A-37 Redundant Mode Operation (9000 W AC-input Power Supply)

Power Supply 1			Watts @ 3.3 VDC	Watts @ 12 VDC (Data)	Watts @ -50 VDC (PoE)	Total Power (W)
Input 1	Input 2	Input 3				
110 VAC	—	—	40	960	1000	1100 (max)
110 VAC	110 VAC	—	40	1460	2000	2200 (max)
110 VAC	110 VAC	110 VAC	40	1460	2500	3300 (max)
220 VAC	—	—	40	1460	2500	3000 (max)
220 VAC	220 VAC	—	40	1960	5000	6000 (max)
220 VAC	220 VAC	220 VAC	40	1960	7500	9000 (max)



Note

In redundant mode, the two power supplies must have identical inputs and all inputs must be at the same voltage. If either of the two power supplies is unpowered, there is no redundancy.

In combined mode, each of the two power supplies provides approximately 83% of its capacity to the switch. This allows for greater utilization of the power supplies with increased PoE densities. In the event of a power supply failure, the system powers down all devices except the supervisor. During this time, there will be a temporary network outage while power is restored to the system. Table A-38 lists the power supply input voltage combinations, the power share ratio between the two supplies and the power available to the chassis.

Table A-38 Power Supplies Combined Mode Ratios and Capacities

PS1 Input Voltage 1/2/3	PS2 Input Voltage 1/2/3	12 VDC Share Ratio	-50 VDC Share Ratio	Watts @ 3.3 VDC	Watts @ 12 VDC (Data)	Watts @ -50 VDC (PoE)	Total Power (Watts)
110/110/110	110/110/110	45/55	40/60	67	2628	4150	5423
110/110/—	110/110/—	45/55	40/60	67	2628	3320	3606
110/—/—	110/—/—	40/60	30/70	67	1594	1420	1789
110/110/110	110/110/—	40/60	40/60	67	2019	3457	4509
110/110/110	110/—/—	40/60	30/70	67	1616	2364	3596
110/110/—	110/—/—	40/60	30/70	67	1818	1650	2694
220/220/220	220/220/220	48/52	48/52	67	3762	14400	17206
220/220/—	220/220/—	45/55	40/60	67	3762	8300	10137
220/—/—	220/—/—	45/55	40/60	67	2628	4150	4930
220/220/220	220/220/—	45/55	45/55	67	2940	11250	13429
220/220/220	220/—/—	40/60	40/60	67	2168	8300	9893
220/220/—	220/—/—	45/55	40/60	67	2646	6225	7412

Table A-38 Power Supplies Combined Mode Ratios and Capacities (continued)

PS1 Input Voltage 1/2/3	PS2 Input Voltage 1/2/3	12 VDC Share Ratio	-50 VDC Share Ratio	Watts @ 3.3 VDC	Watts @ 12 VDC (Data)	Watts @ -50 VDC (PoE)	Total Power (Watts)
110/110/110	220/220/220	45/55	40/60	67	2628	4150	5423
110/110/—	220/220/—	45/55	40/60	67	2628	3320	3606
110/—/—	220/—/—	40/60	30/70	67	1594	1420	1789

9000 W Power Supply AC Power Cords

Table A-39 lists the specifications for the AC power cords that are available for the 9000 W AC-input power supply. The table includes references to power cord illustrations.

**Note**

All 9000 W AC-input power supply power cords have an IEC60320/C19 appliance plug at one end.

Table A-39 9000 W AC-Input Power Supply Power Cords



Locale	Power Cord Part Number	Length	Cordset Rating	AC Source Plug Type
Japan, North America 120 VAC operation	CAB-US515P-C19-US	9.8 ft (2.98 m)	15 A, 125 VAC	NEMA 5-15P  120354
Japan, North America (nonlocking) 200–240 VAC operation	CAB-US620P-C19-US	13.2 ft (4.02 m)	20 A, 250 VAC	NEMA 6-20 non-locking  120355
Europe	CAB-AC-2800W-EU= CAB-CEE77-C19-EU=	13.2 ft (4.0 m)	16 A, 250 VAC	CEE 7/7  120357
International	CAB-AC-2800W-INT= CAB-I309-C19-INT=	13.6 ft (4.1 m)	20 A, 250 VAC	IEC 309  120360
Japan, North America (locking) 200–240 VAC operation	CAB-AC-2800W-TWLK= CAB-L620P-C19-US=	13.6 ft (4.1 m)	16 A, 250 VAC	NEMA L6-20  120361

Table A-39 9000 W AC-Input Power Supply Power Cords (continued)



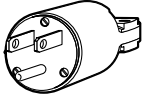
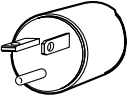
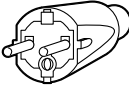
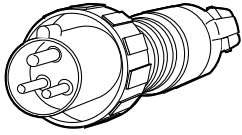

Locale	Power Cord Part Number	Length	Cordset Rating	AC Source Plug Type
Australia	CAB-AC-16A-AUS CAB-A3112-C19-AUS=	14 ft (4.3 m)	16 A, 250 VAC	AU20S3  275667
Argentina	CAB-IR2073-C19-AR=	14 ft (4.3 m)	16 A, 250 VAC	IRAM 2073  120356
China 200–240 VAC operation	CAB-9K16A-CH	14 ft (4.3 m)	16 A, 250 VAC	GB16C  275664
Switzerland	CAB-ACS-16	8 ft (2.9 m)	16 A, 250 VAC	G23  275665
India	CAB-SABS-C19-IND	14 ft (4.3 m)	16 A, 250 VAC	SABS 164-1  275666
United Kingdom	CAB-AC-2800W-INT CAB-I309-C19-INT	14 ft (4.3 m)	16A, 250 VAC	IEC 309  0360
Italy	CAB-C2316-C19-IT=	14 ft (4.3 m)	16 A, 250 VAC	CEI 23-16  120358
Israel	CAB-S132-C19-ISRL=	14 ft (4.3 m)	16 A, 250 VAC	SI 16S3  130922

Table A-39 9000 W AC-Input Power Supply Power Cords (continued)

Locale	Power Cord Part Number	Length	Cordset Rating	AC Source Plug Type
Brazil	CAB-EL224-C19-BR=	8 ft (2.9 m)	16 A, 250 VAC	NBR 14136  275665
UPS 220V	CAB-C19-CBN	9 ft (2.74 m)	20 A, 250 VAC	IEC-60320-C20  130923

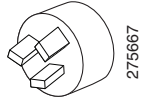
Remote Power Cycling Feature

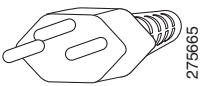
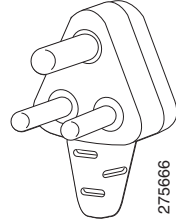
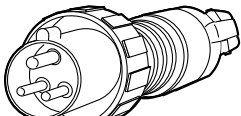
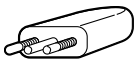
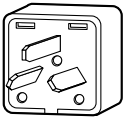
The 9000 W AC-input power supply is equipped with a remote power cycling feature that allows you to remotely turn on or turn off the power supply through an external relay controller box. [Figure A-11](#) shows a typical remote power on/off setup. A three-position terminal block, located on the lower right quadrant of the power supply faceplate, provides the interface to the external relay controller box. (See [Figure A-11](#).)

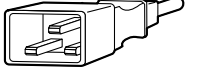
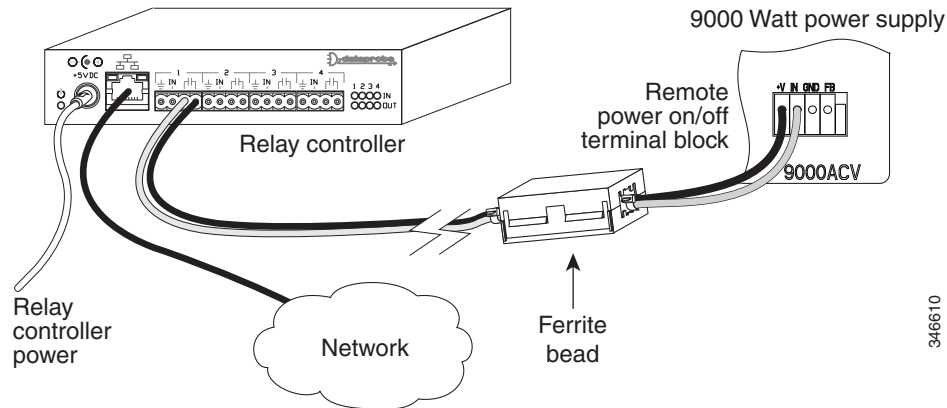
Figure A-11 Remote Power On/Off Feature Components (9000 W Power Supply)

Terminal Block

The terminal block has four contacts labeled +V, IN, GND, and FB. Two control wires from an external relay controller box attach to either +V and IN or IN and GND. +V and IN are used when the relay controller box contains a normally-open (NO) type of relay. IN and GND are used when using an RS-232 interface.

Ferrite Bead

A plastic bag containing one ferrite bead and two 4-inch plastic ties is included with the 9000 W power supply AC power cords. The ferrite bead is a passive device that limits high-frequency interference on interface and control cables and is only required when you install the remote power-cycling feature that is supported by the 9000 W power supply. The ferrite bead is installed on the two control wires that come from the relay controller box to the terminal block on the 9000 W power supply. The ferrite bead should be installed as close as possible to the power supply terminal block for the bead to be effective. You do not need the ferrite bead for 9000 W power supply installations that do not include the remote power-cycling feature.

Remote Power-Cycling Operation

This feature allows you to remotely power cycle the Catalyst 4500 E-series switch using any appropriate third-party relay controller. This feature eliminates the need for you to have access to the supervisor engine console or CLI to control power cycling. [Table A-34](#) lists the relay controller box relay type, the corresponding power supply terminal block positions, and a description of the power-cycling operation.

Table A-40 9000 W Power Supply Relay Controller Switch Settings and Operation

External Relay Controller Box Relay Type	Power Supply Terminal Block Positions Used	Remote Power-Cycling Operation
Normally open (NO) relay.	The +V pin is internally pulled up to 12 VDC with a 10 K ohms pull up resistor, and pin IN is connected to the input pin (either pin 1, 4, 10, or 13) of the line receiver.	<ul style="list-style-type: none"> Power supply cycled from on to off. The power supply is powered off by energizing the relay (relay contacts go from open to closed) for more than 5 seconds. Power supply cycled from off to on. The power supply is powered on by reenergizing the relay (relay contacts go from closed to open) after a 10 second delay.
RS232 driver.	Pin IN is connected to the input pin (either pin 1, 4, 10, or 13) of the line receiver, and pin GND is connected to ground. A capacitor of 1 uF should be used between the line receiver input and the ground to bypass noise peaks.	<ul style="list-style-type: none"> Power supply cycles from on to off. The power supply is powered off by RS-232 logic HI for more than 5 seconds. Power supply cycles from off to on— The power supply is powered on by RS-232 logic LO after a 10 second delay.
No relay attached. Remote power-cycling feature not installed.	—	—

Environmental Monitoring Feature

With the environmental monitoring and reporting feature, you can keep your system running by resolving adverse environmental conditions before a loss of operation.

The power supply monitors its own internal temperature and voltages. In the event of excessive internal temperature, the power supply shuts down to prevent damage. When the power supply returns to a safe operating temperature, it restarts. If the power supply output voltage is not within the specified range, the LED labeled OUTPUT FAIL will light. An instance of substantial output overvoltage can shut down the power supply.

An instance of substantial input overvoltage (greater than –75 VDC continuous) can damage the power supply input circuitry and can cause it to shut down permanently.

For a 1400 W DC power supply, the main power switch has an input range of –40.5 to –72 VDC, while the –48 V PoE operates over a range of –40.5 to –56 VDC. The PoE either fails to start or shuts down if exposed to greater than –56 VDC input. PoE recovers after you recycle input power within the proper voltage range. If the PoE shuts down due to input overvoltage (greater than –56 VDC), the main converter section does not shut down.

The supervisor engine monitors the status of each power supply and provides a status report through the switch software. For more details on how the supervisor engine monitors the power supplies, see the “Environmental Monitoring and Power Management” chapter of the *Catalyst 4500 Series Switch Cisco IOS Software Configuration Guide*.

Power Redundancy

All Catalyst 4500 E-switches offer 1+1 power redundancy, so that in the event of a power interruption the switch can still operate using power from another circuit. The power supplies can also run in a combined mode so that chassis can have power from both supplies at once. Use the **power redundancy-mode** command to configure combined mode. Redundant mode is the default.

Catalyst 4500 E-switches support power supply redundancy only between power supplies of equal wattage and type. A mix of power supplies is not supported. The second power supply recognized is placed into errdisable mode.

A more detailed discussion of power redundancy is in the “Environmental Monitoring and Power Management” chapter of the software configuration guide. Refer to the appropriate guide for your software release.

